



DICHTOMATIK

Any seal. Any time.



旋转密封

a brand of



FREUDENBERG



DICHTOMATIK

旋转密封

Albert-Schweitzer-Ring 1
D-22045 Hamburg
P.O.Box 70 04 80
D-22004 Hamburg
Phone +49/40/66 98 90
Fax +49/40/66 98 91 01
mail@dichtomatik.de
www.dichtomatik.de



DIN EN ISO 9001:2008

目 录

关于Dichtomatik	5
旋转油封	6
材料	7
密封机理	14
操作参数	20
安装座孔	25
安装须知	32
特殊应用	33
储存	35
径向油封概览	36
轴向密封概览	38
产品形式	40
尺寸列表	69
分支机构	313

Dichtomatik

Any seal. Any time.

作为您身边的密封专家，德克迈特德氏封(Dichtomatik)一直致力于随时随地为客户提供各种专业的密封解决方案。我们库存密封产品多达55,000种以上，可以及时满足客户的任何密封需求。

为了扩大服务范围，在常用的115,000种产品基础之上，我们还一直在持续不断开发各种客户专用的密封产品及方案。高效一体化的操作系统，保证了从下单、收货到安装每个环节完整的客户服务。在汉堡总部的仓储中心，我们目前有12个高效物流系统，共占地6,000平方米。此外，各地分支机构拥有各自足够的库存以满足当地市场的特定需求。由于有全自动的系统支持，客户下单后只需几步操作即可发货。目前仅欧洲区域，我们每个工作日便可发出7,500种密封产品。

www.dichtomatik.de

登录德氏封的网站，您可以很方便地进行如下操作：

查看我们的库存、查询标准密封件的供货信息、了解材料说明和安装建议等关于密封件的技术信息。输入个人账户密码后，您还可以全天24小时查询价格、询价及下单。

德克迈特德氏封(Dichtomatik)始终致力于持续改进并不断优化内部操作流程和客户服务。我们拥有在速度、灵活性和技术应用方面最为优异的客户支持服务，而这也正是德克迈特德氏封(Dichtomatik)成为您在密封行业最值得信赖的合作伙伴的主要原因。



旋转油封

旋转油封用于密封旋转机械元件以防止内部介质泄漏或避免外部污物入侵。密封型号的选择取决于操作参数，例如工作介质、温度、圆周速度、压力和周围空气情况。

旋转油封由橡胶组件、加强金属骨架和自紧弹簧组成。

旋转油封的外包层可以是弹性橡胶，也可以是金属，兼顾静态密封和在座孔中的固定作用。金属骨架能够提供旋转油封所必需的稳定性，而弹簧则通过自身的自紧力向密封唇施加了压向轴表面的径向力，以达到密封效果。同时还可以使用防尘唇来防御外界污物和灰尘的入侵。

类型

按结构形式，我们将其分为三种基本类型。WA 型，骨架外包橡胶，具有可靠的外缘密封性能；WB 型，外露金属骨架，安装在座孔内稳固且精确定位；WC 型，外圈金属骨架侧面有副外壳加固的带金属插片的组合油封，刚度强，适用于恶劣工况以及难以安装的情况。

标准

德克迈特德氏封 (Dichtomatik) 的旋转密封符合 DIN 3760 标准。关于设计注意事项和安装指南，请参见第 25 页。

适用范围

旋转油封主要应用于旋转轴轴端密封，如以下行业中的轴杆、轮毂和轮轴等：

- 驱动技术，如变速器、电机和内燃机。
- 泵。
- 农业机械和建筑工程机械中暴露在极端油污的元件，以延长维修周期，保证使用寿命。
- 家用和工业用清洗机（白色家电）。油封材料需耐高温，且与水 and 肥皂水相兼容。
- 风力产业，造船厂和轧钢厂尤其需要大型旋转油封。

要求

旋转油封的主要目的在于确保密封的可靠性和密封功能。同时，为了尽可能减少密封周围区域产生的热量，进而最大程度地降低动力损耗，还应减少次要机械影响（如轴摩擦）。此外，旋转油封应设计简单，方便安装和拆卸。

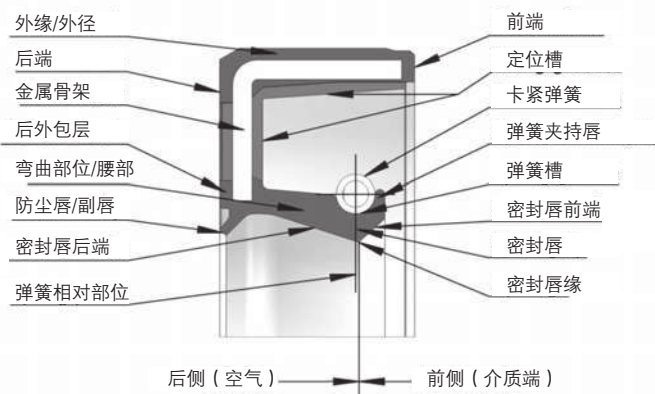

常用材料

旋转油封的密封唇（弹性组件）、金属骨架和弹簧根据不同的产品类型和应用情况可采用不同的标准和特殊材料。

旋转油封的密封唇基本材料是合成橡胶，根据 DIN ISO 1629 和 ASTM D1418 标准中的术语，它有多种聚合物可以选择。

混炼后的橡胶由基础橡胶及所需的填充材料、软化剂、加工助剂、硫化剂、催化剂和其他添加剂混炼而成。

该过程可以设定材料所需特性，使标准材料具有广泛的用途，并使特殊聚合物得以应用于极为特殊的环境中。

旋转油封是通过硫化将金属嵌件连接至弹性体元件，使其具有橡胶弹性和机械特性，后续通过切割或在模具中成型形成唇口，最后安装预紧弹簧。

密封唇材料术语：

化学描述

丁腈橡胶
氢化丁腈橡胶
氟橡胶
三元乙丙橡胶
硅橡胶
丙烯酸酯橡胶

聚四氟乙烯

缩略词

DIN ISO 1629	ASTM D 1418
NBR	NBR
HNBR	HNBR
FKM	FKM
EPDM	EPDM
VMQ	VMQ
ACM	ACM
DIN EN ISO 1043-1	ASTM D 1600
PTFE	PTFE

标准弹性体材料

德克迈特德氏封 (Dichtomatik) 可以现货或在短时间内提供由两种标准弹性体材料和两种 PTFE 材料组成的旋转油封

旋转油封所使用的标准弹性材料

基础弹性体	DIN ISO 1629	硬度 [邵氏 A]	颜色	温度 [°C]
丙烯腈-丁二烯橡胶	NBR	70	黑色	-40 ~ +100 瞬时 +120
氟橡胶	FKM	80	棕色	-30 ~ +200

旋转油封所使用的标准PTFE材料

WEPO和WCP21型

基础聚合物	DIN EN ISO 1043-1	填充材料	硬度 [邵氏 D]	温度 [°C]
聚四氟乙烯	PTFE	碳/石墨	62	-30* ~ +205 WEPO
聚四氟乙烯	PTFE	玻璃纤维/MoS2	60-80	-90 ~ +250 WCP21

*温度范围取决于WEPO的氟橡胶O型圈

材料 快捷查询

温度 (°C)



圆周速度 (m/s)

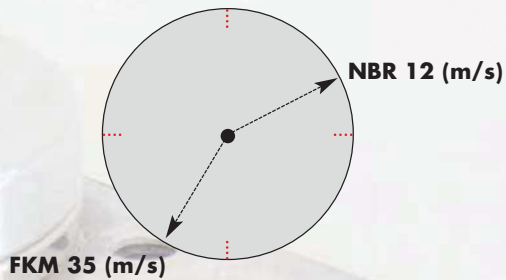

标准材料/
耐介质性能

NBR 70

颜色: 黑色
 弹簧: 符合DIN EN 10270-1标准的非合金弹簧钢
 金属骨架: 符合DIN EN 10139标准的非合金钢

FKM 80

颜色: 棕色
 弹簧: 不锈钢
 1.4301 (AISI 304)
 金属骨架: 符合DIN EN 10139标准的非合金钢

NBR

具有良好的耐多种矿物油和油脂的特性。

FKM

广泛的耐化学物质和溶剂的特性, 包括矿物油和油脂、合成油和油脂、马达、变速器和ATF油、燃油、芳香剂和氯化烃类。

请参见本目录第24页的耐介质特性表。

产品代码示例

产品组

设计型号

类型

材料

W

A

S

NBR

W

A

SY

W

B

O

FKM

W

C

防尘唇
 防尘唇 + 压力
 无弹簧

旋转油封

橡胶外缘

金属外缘

金属外缘 + 侧面加强环

NBR-丙烯腈-丁二烯橡胶/ 商标名:

Perbunan® (拜耳)

NBR是最常用的旋转密封的橡胶材质，不仅因为它良好的机械性能和耐矿物油基润滑油和润滑脂的性能，而且和特殊聚合物在一起时还适用于燃料。

它的特性主要取决于其丙烯腈含量（ACN在18%和50%之间）。低ACN含量能够确保在低温下具有良好的弹性，但耐矿物油和燃油性有限；随着ACN含量的增加，低温下的弹性降低，但耐矿物油和燃油性则会提高。

旋转密封的标准NBR材料中ACN含量均衡，适用范围广，性能稳定。且该材料具有良好的机械性能如高耐磨性，并具有优良的耐矿物油基润滑剂和油脂性，以及液压油H、H-L、H-LP、抗燃液压油HFA、HFB、HFC、脂肪烃、硅油、油脂和不高于+80°C的水。

NBR通常不耐芳香族和氯化氢化合物、含高度芳香剂的燃料、极性溶剂、乙二醇制动液和抗燃液压油HFD等。

它的耐臭氧、抗气候和抗老化性能较弱，但多数应用中（例如，当材料被油浸湿时）不会影响使用。

FKM - 氟橡胶/商标名: Viton® (杜邦)

FKM的特点在于优异的耐高温和化学物性。其他主要优势为极高的抗老化和抗臭氧特性、极低的气体渗透性（非常适用于真空应用）以及自熄性。

旋转密封所用的标准FKM具有卓越的耐矿物油性和油脂、脂肪烃、芳香族烃、氯化碳氢化合物、燃料、难燃液压油HFD以及许多有机溶剂和化学物等特点。

FKM通常不耐热水、蒸汽、极性溶剂、乙二醇制动液和低分子有机酸。

PTFE - 聚四氟乙烯

PTFE是一种氟化塑料。因为其一系列的优异性能使得它成为密封领域中必不可少的产品。

它的杰出性能表现在：几乎耐所有的化学物、耐温性极强（-90°C - 250°C）、摩擦系数极低，滑行无障碍、无粘滑效应、且无条件地耐臭氧、耐候和抗老化。旋转密封用的PTFE通常含有填充剂，比如：炭黑、石墨或玻纤等。

旋转密封中，PTFE通常用来作为密封唇或密封唇的镀层材质。一些特殊应用场合，比如要求耐介质、耐热、承受高旋转速度、低摩擦和耐高压的情况下，就要求整个密封的材质都是PTFE，而不只是一部分。德克迈特德氏封（Dichtomatik）WEPO型的旋转油封材质为PTFE+炭黑/石墨，且有库存。德克迈特德氏封（Dichtomatik）可以在短时间内提供密封唇材质为PEFE+玻纤/二硫化钼的WCP21型密封。若有要求，我们也可提供密封主体为橡胶材质，但密封唇为PTFE涂层的密封。

特殊弹性体材料

除上述标准弹性体材料外，还有多种特殊弹性体材料可用于特殊应用。

包括低摩擦性的材质（添加了抗摩擦填料，如石墨或二硫化钼（MoS₂）），和其他更好的耐介质和高 / 低温的优化材料。

基础弹性体	DIN ISO 1629	硬度 [邵氏 A]	颜色	温度 [°C]
氢化丁腈橡胶	HNBR	70	黑色	-40 至 +150
NBR 高腈	NBR	70	黑色	-30 至 +100
NBR 高温	NBR	70	黑色	-30 至 +120
NBR 低温	NBR	70	黑色	-50 至 +90
NBR 石墨	NBR	70	黑色	-40 至 +100
NBR MoS ₂	NBR	70	黑色	-40 至 +100
硅橡胶	VMQ	70	红色	-50 至 +200
丙烯酸酯橡胶	ACM	70	黑色	-25 至 +150
三元乙丙橡胶	EPDM	70	黑色	-40 至 +130

还可以提供更多不同硬度和颜色的材质。

HNBR - 氢化丁腈橡胶/商标名: Therban® (拜耳)

HNBR 是通过对 NBR 进行完全或部分氢化获得。因此它在抗热、抗臭氧和抗老化方面有显著改善，并具有良好的机械特性（如良好的耐磨性）。其耐介质性可与 NBR 相媲美。

NBR 高腈 - 更高的ACN含量

与标准 NBR 相比，它的耐油和燃料性能更好。

NBR 高温

与标准 NBR 相比，它可以耐更高的温度，耐持续高温可达 +120°C。

NBR 低温

ACN 含量低，适用于更低温度范围，耐持续低温为 -50 ~ +90°C。

NBR 石墨 / NBR MoS₂

内含抗摩擦填充剂，如石墨和 MoS₂，可达到优化的低摩擦和易滑行性能。

VMQ - 硅橡胶/商标名: Silopren® (拜耳)

硅橡胶的特点在于其宽泛的热应用范围以及其良好的耐臭氧、耐气候和抗老化性。与其他弹性体相比，它的机械性能较弱。一般来说，硅橡胶具有生理安全性，即可应用于食品相关领域和医疗行业。

标准硅橡胶适用于 -50°C 至 +200°C 温度范围，且耐脂肪族机油、动植物油和脂肪。但不耐燃料、芳香族矿物油、蒸汽、硅油、油脂、酸性物质和碱性物质。

ACM - 丙烯酸酯橡胶

ACM 耐机油、润滑油和 ATF 油，主要用于汽车工业。按应用来说，它介于 NBR 和 FKM 之间。适用温度为 -25 ~ +150°C。

EPDM - 三元乙丙橡胶/商标名: Nordel® (杜邦)

EPDM 具有显著的耐热水、蒸汽、洗涤剂、泡碱、氢氧化钾溶液、硅油、油脂、多种极性溶剂、稀释酸和化学物质性能，其热应用范围相当宽泛，但它不适用所有的矿物油产品（润滑油、燃料）。

弹簧材料

标准弹簧

符合 DIN EN 10270-1 标准的非合金弹簧钢

非标弹簧

WA FKM, WAS FKM

(FKM 标准旋转油封): 抗锈耐酸钢 1.4301 (AISI 304)

WEPO

(PTFE 旋转油封): 抗锈耐酸钢 1.4571 (AISI 316)

此外，其他型号也可匹配抗锈耐酸弹簧 1.4301 (AISI 304) 或 1.4571 (AISI 316)。

金属骨架材料

标准材料

符合 DIN EN 10139 标准的非合金钢

特殊材料

抗锈耐酸钢 1.4301 (AISI 304)

密封机理

外缘的静态密封

旋转油封外缘的主要作用是确保座孔内的静态密封性，即必须在任何工作条件下防止介质外泄。

旋转油封的外缘还须具有其他功能：

- 引导并将旋转油封以过盈方式压入座孔内。摩擦力 F_R 要大于轴向力 F_{ax} 以确保旋转油封被牢固地固定在座孔中，从而保证其静态密封性。摩擦力 F_R 是静态摩擦系数 μ_0 与径向力 F_N 的计算结果。径向力 F_N 等于外缘的径向压力 F_A 。

- 根据不同的外缘形式，对于不同的公称直径要采用不同的过盈公差（参见第 16 页表格“过盈配合公差”）。

- 要有合适的圆角或倒角以便于安装。

- 补偿由于不同热膨胀系数而产生的间隙。

旋转油封外缘的选择取决于特定应用工况。

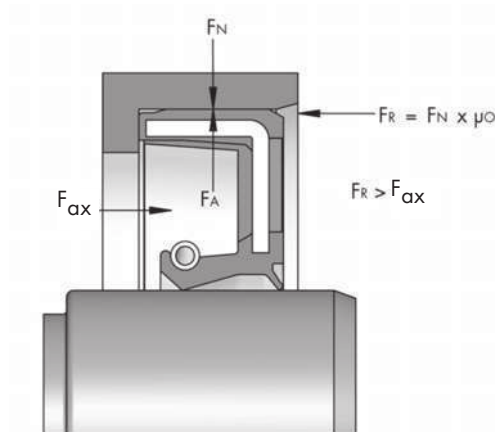

旋转油封外缘类型

通常情况下，旋转油封的外缘为弹性橡胶和金属。德克迈特德氏封 (Dichtomatik) 可以提供 2 种混合材质的外缘和其他特殊类型的外缘密封。各种不同外缘类型的密封描述如下：

橡胶外缘型：WA和WAS

光滑橡胶外缘，即使在条件苛刻的使用环境下也具有可靠的静态密封效果。带防尘唇的型号为 WAS。

- 出色的静态密封性。
- 适用于分体式座孔，特别是座孔边缘破损或者整体偏移时。
- 适用于高热膨胀的轻金属座孔（所有座孔热膨胀系数高于金属）。

- 适用于轻质液体或气体介质。
- 适用于压力环境（在应用限制范围内）。
- 适用表面粗糙度大的环境密封。
- 无摩擦。
- 座孔在安装和位移时无损坏。

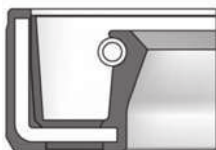

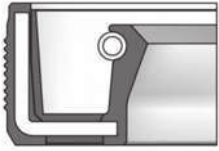

波状橡胶外缘型：WAK

为降低压入力并提高静态密封效果，外包橡胶外圈呈波状。

- 所需的压入力较小，易安装。

- 确保静态密封效果，尤其适用于热膨胀系数大的座孔。波状橡胶面使压入力更小。

- 避免旋转油封的永久性扭曲。

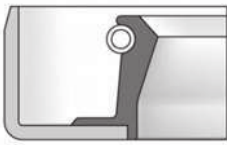

金属骨架外缘型：WB和WBS

光滑金属骨架无外包层。

- 座孔内安装稳固，且定位极精准（中心位置）。
- 弹性体橡胶含量少，成本低。
- 更易压入。
- 对座孔表面质量要求高。
- 不适用于分体式腔体（限制性应用于有涂层的分体式腔体）。

如果座孔内表面粗糙度大或热膨胀、有压力、低粘液或者出现介质泄漏时，需要在外缘表面涂上密封剂（参见第 16 页“附加密封剂”）。

为防止腐蚀，金属外表面会涂抹防腐油或薄蜡层。

带防尘唇的型号为 WBS。

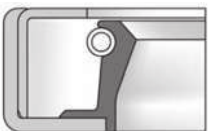

带金属插片的金属骨架外缘型：WC、WCS

WC 旋转油封同 WB 一样具有平滑金属外缘，且侧面带有金属插片。适用于恶劣工况或难以安装场合以及较大尺寸。

由于有额外的金属插片，因此 WC 型对安装失误不敏感。

带防尘唇的型号为 WCS。

WC 型旋转油封的刚度大于 WB 型。

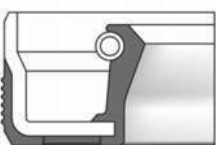

部分橡胶外缘型：WAB

这种“外缘半包”型是旋转油封的一种特殊设计，非德克迈特德氏封（Dichtomatik）的标准库存型号。

该型号结合了 WA 橡胶外缘型和 WB 金属外缘型的优势，确保了静态密封性和在座孔内的稳固。

其金属外缘安装时可确保良好的中心定位。

波状橡胶外缘使该型号能够成功应用于具有高膨胀系数和分体式座孔内。

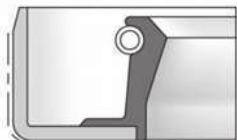

带有外缘辅助密封的 WBM/WCM

为达到座孔内良好静密封效果，通常会在金属外缘的旋转油封的金属表面涂有涂层或者密封剂。蜡或涂层也能起到防腐作用。

涂层可以补偿旋转油封外表面上的加工痕迹、座孔的粗糙度以及明显的热膨胀。它还可防止安装或拆卸时对座孔造成的损坏。

涂层厚度一般约为 $30\mu\text{m}$ 。当与介质接触时，涂层体积会发生膨胀，从而提供额外的静态密封。涂层本身有一定的粘合性，所以带有涂层的密封在安装时需要增加一定的压力。

涂层可采用不同的颜色，即蓝色、深红色、橙色、深绿色和浅绿色。

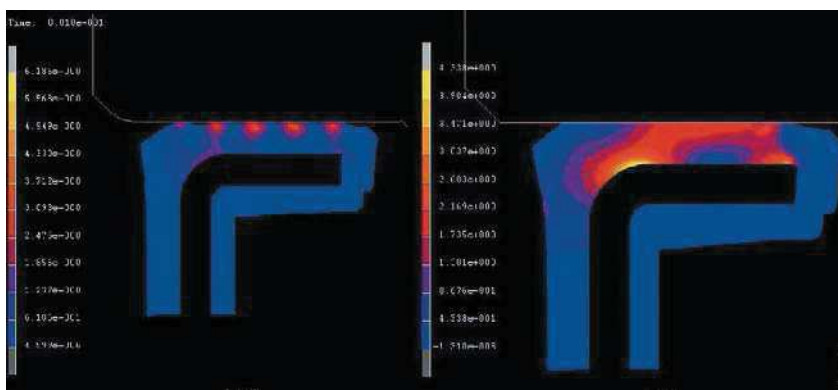

使用有限元法模拟座孔的静密封

过盈配合公差

根据不同类型旋转油封，其外缘具有不同的过盈公差。该过盈公差与按照 ISO H8 公差加工的座孔相对应配合。这就确保了油封在座体孔内能够紧实安装，并具有适当的压入力和压出力以及良好的静密封性。

外径 d2[mm]	WA型	WAK型	WB型、WC型
≤ 50	+ 0.3	+ 0.4	+ 0.2
> 50 - 80	+ 0.15	+ 0.2	+ 0.1
> 80 - 120	+ 0.35	+ 0.45	+ 0.23
> 120 - 180	+ 0.2	+ 0.25	+ 0.13
> 180 - 300	+ 0.35	+ 0.5	+ 0.25
> 300 - 500	+ 0.2	+ 0.3	+ 0.15
	+ 0.45	+ 0.65	+ 0.28
	+ 0.25	+ 0.4	+ 0.18
	+ 0.45	+ 0.65	+ 0.3
	+ 0.25	+ 0.4	+ 0.2
	+ 0.55	+ 0.75	+ 0.35
	+ 0.33	+ 0.45	+ 0.23

不圆度

对圆周进行三次或多次均匀测量后可得到不圆度公差($d_{2\text{max}} - d_{2\text{min}}$)。切勿超过规定值。由于安装时旋转油封会自适应于定位孔，因此当不圆度公差在规定内时，圆度是次要的。

外径 d2[mm]	不圆度公差 [mm]
≤ 50	0.25
> 50 - 80	0.35
> 80 - 120	0.5
> 120 - 180	0.65
> 180 - 300	0.8
> 300 - 500	1

动态密封机理

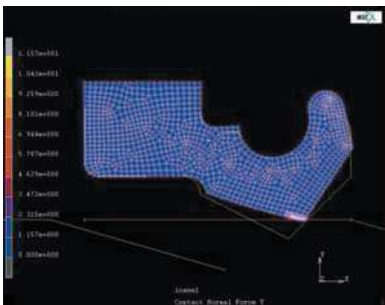

旋转油封的工作原理是弹性体密封唇口与旋转轴表面接触的动态密封。在自由状态下密封唇的内径小于轴直径，因此密封唇口会对轴表面施以径向压力。这种直径差称为预紧力。

另外，还通过一个金属弹簧来确保线性接触区上产生的径向力，从而抵消由于弹性体材料老化所造成的径向力退减（应力松弛）。

弹性体密封唇口处的密封作用对以下

两种功能状态有效：

- 固定轴
- 旋转轴

密封效果取决于以下参数：

- 密封唇几何形状
- 弹性体材料的性能
- 弹簧的校准
- 轴表面的光洁度
- 润滑条件
- 被密封介质

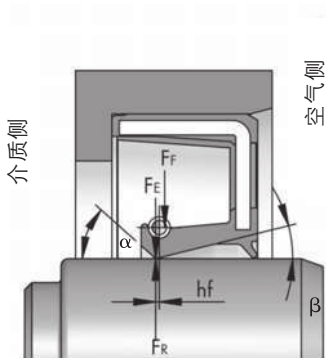

静态轴密封

当轴处于静态状态时，密封作用取决于无螺纹轴表面上的密封唇的径向接触压力。密封唇口的变形弥补了轴表面粗糙度也能填补空隙。密封唇施加于轴上的径向压力来自预紧力以及弹簧的自紧力。操作时弹性体预紧力的减小取决于应用参数。

因此，径向力 F_R 由弹性体预紧力 F_E 和弹簧自紧力 F_F 组成。

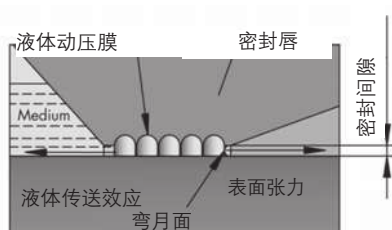

动态旋转油封

动态密封时，轴的动态旋转会产生液压动态效果从而使密封唇漂浮在润滑介质形成的油膜上。这就可以防止密封唇的过早磨损和热损坏。

一方面，要确保这种防止密封唇被磨损的润滑膜可以保留在接触面上，另一方面还要防止润滑介质流到空气侧产生泄漏。

触压力分布不均匀时，才能获得所需的转轴密封的“进给作用”。这时“微螺纹轴泵”才能以正确的方向进给。接触压力不对称分布一部分是由密封唇与轴表面之间接触面的不同角度 ($\alpha > \beta$) 造成，另一部分则由螺旋弹簧向空气端的移动(弹簧距离)造成。

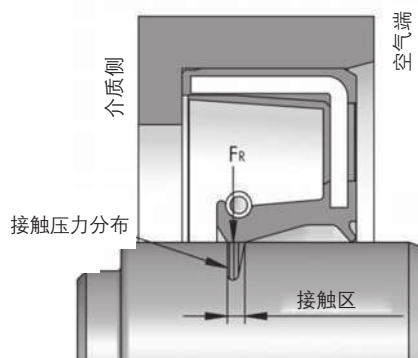

一旦新的旋转轴密封开始启用，弹性体接触区内会轴向形成液体动压膜。它们会因为密封唇和轴之间的相对运动而出现变形，然后根据接触区的接触压力分布情况以及轴的旋转方向进行调整。它们将会在接触区域从空气侧到介质侧形成进给效应（粘性流体），该效应等同于一个“微螺纹轴泵”。仅在轴向接

由于弹性体突出物的倾斜使得接触区的介质不仅沿圆周进给，同时还沿轴向进给。此外，在润滑剂等润湿介质的作用下，表面张力会影响泄漏方向。在毛细力的作用下，这些介质被卷入密封空隙并在空气端形成弧形介面，即“弯月面”。在“紧实”转轴密封的工况下，引起一侧泄漏的力（压差和毛细作用）和另一侧弹性体突出物的泵吸效应会达到一个平衡点。

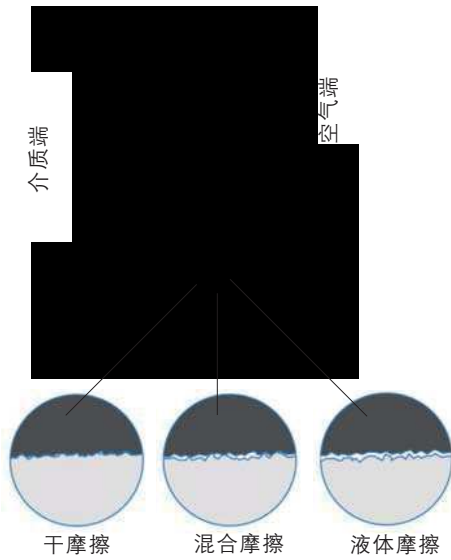

接触区的摩擦条件

摩擦条件和润滑

旋转轴、旋转油封和润滑剂相互作用，构成摩擦系统。在摩擦点，润滑剂等同于固体组件，对系统的操作可靠性及使用寿命起决定作用。

即使转速较低时，介质也会因毛细力作用而渗入接触区。介质在毛细力作用下沿泄漏方向进给，这对承受极热应力的接触区润滑来说是必不可少的。

最常见的情况是在旋转轴和密封唇之间出现混合摩擦。这时两个接触表面的材料极为重要。

如果轴转速较高，摩擦状况会从干摩擦转变为混合摩擦，再变成流体摩擦。高转速以及流体动力效果会导致密封唇漂浮在由被密封的介质形成的润滑油膜之上。

该流体动力润滑膜能够防止弹性体密封唇口因现有摩擦而过早磨损或出现热破坏。为确保使用寿命的长期性，必须使密封唇口得到充分持续的润滑。径向力、旋转油封材料、待密封介质的润滑情况、圆周速度、温度、压力和旋转轴表面处理情况对摩擦和摩擦损耗有决定性影响。

摩擦能量：

$$P_{REIB} = F_R \cdot \mu \cdot d/2 \cdot 2 \cdot \pi \cdot n$$

P_{REIB} = 摩擦能量 [Watt]

F_R = 径向力 [N]

μ = 摩擦系数

d = 轴径 [mm]

n = 转速 [1/min]

由于无法准确测定单项操作条件下的摩擦系数，因此该计算方式仅作参考。

为了将摩擦损耗维持在最小水平，要尽可能施加小的径向力。但是，径向力必须能够起到密封功能。

如果密封唇口下方所需的润滑膜受到干扰例如受介质污染、接触面损坏或轴表面粗糙度过高，则会发生泄漏。

由于圆锥滚子轴承、角接触球轴承和一些齿轮类型等机械零件会产生进给效果，从而削弱密封点的润滑供给。因此，应在设计阶段采取适当措施以保证润滑剂的供给，例如采用润滑导管等措施。

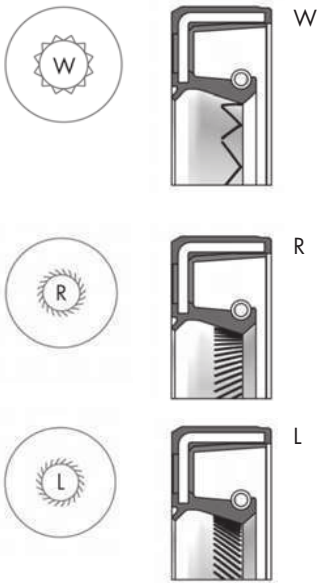

螺旋回流纹的多种设计

干摩擦

由于摩擦热会导致轴密封唇过早磨损，因此切勿转动未经润滑的转轴。

应在安装前稍微润滑旋转油封的密封唇口。除被作为润滑剂外，待密封介质也会耗散摩擦热。

对于有干摩擦应用的场合，可采用特殊设计的 PTFE 密封唇。

油脂润滑

对于纯油脂润滑，其摩擦热量耗散性能比油润滑要小的多。这仅适用于低速旋转且旋转轴的圆周速度不可超过矿物油润滑的允许值（参见第 22 页转速表）。

对于密封低转速的旋转轴，我们建议用油脂完全填充旋转轴密封和轴承之间的空隙。如果没有适合的润滑油脂，可使用带有 PTFE 密封唇的旋转油封。

针对不良润滑介质的密封

对不良润滑介质（如水或肥皂水）进行密封时，密封唇和保护唇之间 30%–40% 的空间必须用油脂填充，以保证密封唇口得到充分润滑。对于在串联使用的两个旋转油封之间也必须用油脂填充。为了确保更好的使用效果可以定期充填油脂。

螺旋线回流纹

如果旋转油封的正常回流进给作用不足，则可用螺旋线回流纹来作为额外的回流辅助以提高旋转油封的密封功能。螺旋线回流纹是从空气侧到密封侧带有一定倾斜角度的回油进给槽。

根据旋转轴的旋转方向，可使用左旋、右旋或者波纹状螺旋线的旋转油封。螺旋线的用途在于，在正常回流不起作用的情况下，防止介质泄漏至空气端并将其导回密封唇口。因此，带有螺旋线的旋转油封能够提供双重保护，防止发生泄漏。

螺旋线的作用等同简易螺纹式旋转油封。即使是单条螺纹线旋转油封的回流值也远大于标准旋转油封。

带有螺旋线的旋转油封其密封功能更好，尤其是在恶劣的工作条件下（如真实的运转偏差、轴和孔之间的中心定位偏差以及轴表面的轻微损坏）。

操作参数

压力

无压操作

旋转油封一般针对无压应用而设计，即待密封空间之间不存在压力差。

第 22 页转速表显示了多种弹性体材料在无压情况下所允许的最大转速。

耐压操作

旋转油封的选择取决于压力 (p) 和圆周速度 (V)。

对于耐压旋转油封其密封唇会紧压在旋转轴上，根据压力和有效表面（自紧效果）来增加径向力，从而起到密封作用。耐压型旋转油封可以承受一定的压力差。

然而，这个过程还会增加密封唇口的热负荷和摩擦能量，使其过早磨损或发生硬化。如果压力过高，密封唇还会翻转到空气端。

所以选择弹性体材料时，一定要考虑密封唇口会有较高的热负荷（超温）。请注意，第 22 页转速表内的圆周速度和转速建议值不应用于耐压旋转油封的选择。

在耐压旋转油封（WASY）中，密封唇短而坚硬，紧贴在旋转轴上，可以减少轴的运转偏差和轴与定位孔之间的中心定位偏差。

耐压旋转油封必须在无压侧通过座孔肩、定距环或定位环进行轴向固定，以避免被压离座孔。

标准型旋转油封承压应用

标准旋转油封在非常低的压力情况下也可以使用，它们可以密封较小的压差，其密封的介质可以是液体、油脂甚至空气。根据不同的转速其最大使用压差为 0.5 bar。

下表显示了压力限定值，该数值取决于转速和圆周速度。

承压下旋转轴转速的最大允许值

最大压差 [bar]	可允许转速 [1/min]	最大圆周速度 [m/s]
0.5	达到 1000	2.8
0.35	达到 2000	3.15
0.2	达到 3000	5.6

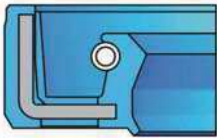

耐压型旋转油封 WAY/WASY

对于压差大于 0.5 bar，脉动压力以及真空应用场合，建议使用 Y 型设计密封。

该型号旋转油封密封唇短而坚强，同时内有稳固的金属骨架。这会降低接触压力，减少摩擦力，防止密封唇过早磨损。

由于密封唇短而坚强，在压力过高时也不会被翻转向空气侧。

根据转速的不同，WAY/WASY 型号的耐压值最高可达 10 bar(见表格)。

压差 [bar]	转速 [1/min]	最大圆周速度 [m/s]
达到10	< 500	0.6
4.5	1.000	2.7
2.4	2.000	5.9
1.3	3.000	8.4
0.6	4.000	11.3

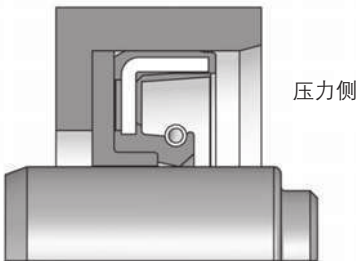

支承环

压力差大于 0.5 bar 时，增加一个支承环，也同样可以使用标准旋转油封进行密封。两者结合使用时，针对不同的转速其允许密封压力可达 10 bar 左右。

由于支撑环要对密封在弯曲部位进行支撑，因此仅可以使用无副唇的旋转油封。德克迈特德氏封 (Dichtomatik) 可根据要求提供每个标准型号 (无副唇) 旋转油封所对应的支承环图纸。

在没有合适的 Y 型耐压旋转油封的情况下，此类组合是最理想的选择。

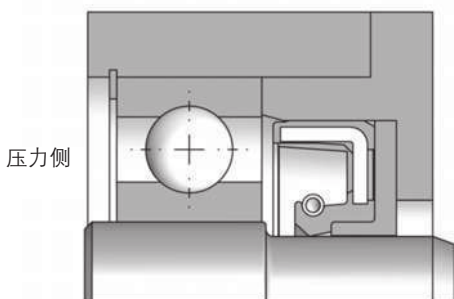

允许转速和圆周速度

根据下列公式，旋转轴的圆周速度 v 是转速 n 和轴直径 d 的乘积：

圆周速度

$$v = (2 \cdot \pi \cdot n) \cdot d / 2$$

v = 圆周速度 [m/s]

n = 转速 [1/min]

d = 轴径 [mm]

为防止密封唇口出现过温现象而导致唇口硬化或碳化，必须限制圆周速度。

下表列出了在最大可允许圆周速度内，弹性橡胶材料选取的推荐值。这些建议值基于与 DIN 3760 标准相关的经验。

对于生产商特别设定的旋转油封特性（如密封唇几何形状或径向力）不在考虑范围内。

下表的建议值仅适用于无压工况，且矿物油充分润滑以及密封处散热良好。在润滑不充分或纯油脂润滑情况下，限定值应减半。在承压、接触区表面质量不佳以及存在较大运转偏差的情况下，也应降低建议值。

较大直径的轴比较小直径的轴拥有更高的允许圆周速度，其原因在于轴横截面以直径的平方数递增。这将产生极佳的散热特性。

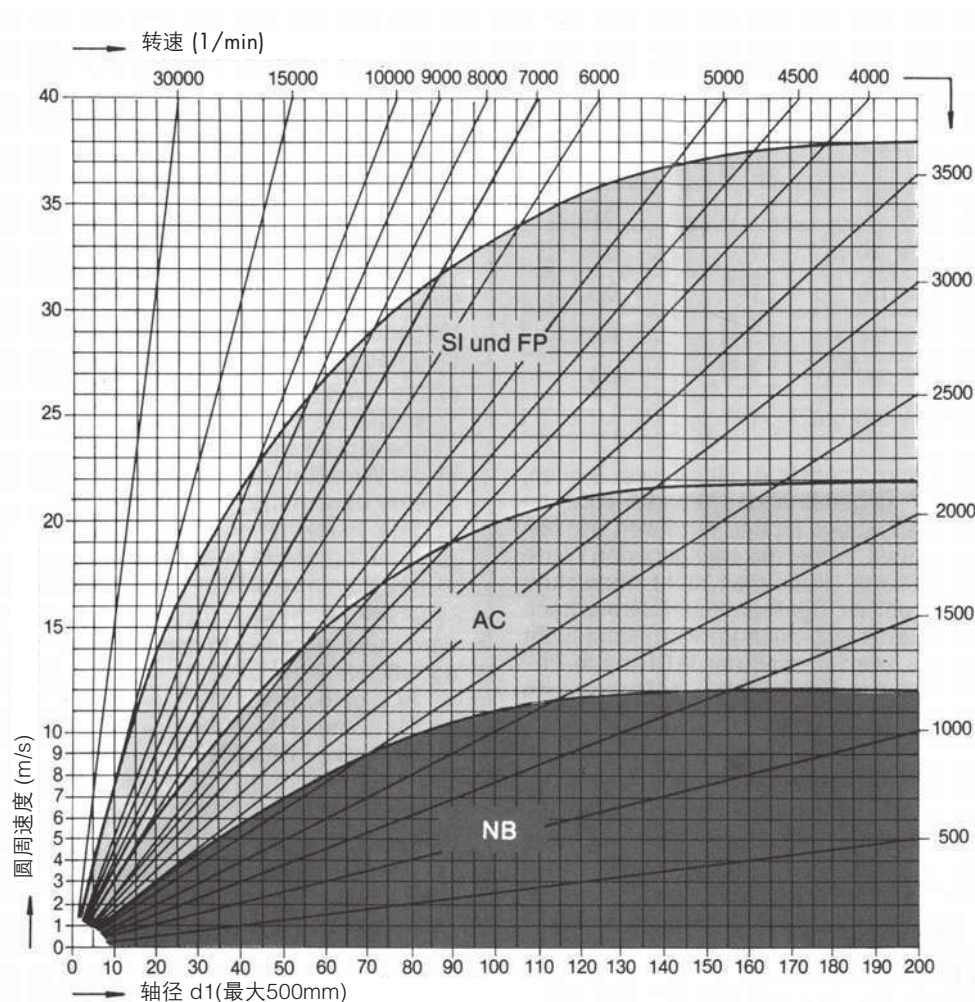

温度

轴的旋转以及由此所产生的密封唇口处的摩擦使得密封唇口处的实际温度高于油池的温度。

$$t_D = t_{\text{öl}} + t_{\text{ü}}$$

t_D = 密封唇口处温度 [°C]

$t_{\text{öl}}$ = 油池内部温度 [°C]

$t_{\text{ü}}$ = 过温 [°C]

油池内部的油温和密封唇口处之间的温差称为过温。

过温的等级取决于以下几个参数：

- 圆周速度
- 润滑条件 / 油位
- 散热性
- 压力载荷
- 轴表面条件
- 旋转油封材料

圆周速度越高，则密封唇口处的过温越高。根据不同的圆周速度，过温可高达 +40°C。

如果超过弹性体材料的最大可允许工作温度，则弹性体材料会过早硬化并极度磨损。

关于德克迈特德氏封 (Dichtomatik) 公司弹性体材料的可允许工作温度，请参见本章节表格 (见第 24 页)。表格中给出的高温指密封唇口处的温度。

待密封的介质

旋转油封的选择，尤其是材料的选择，取决于旋转轴的圆周速度、压力载荷和因摩擦而升高的温度，但最重要的是取决于待密封的介质及其温度。旋转油封的耐介质性对其寿命有决定性影响。

介质的化学腐蚀性会导致

- 因膨胀而产生的材料软化
- 或因高温而产生的硬化和过早老化

具体每种材料的耐介质性均列在德克迈特德氏封 (Dichtomatik) 耐介质表中。如果使用新介质，或有任何不确定情况，或者同时出现最大应用参数 (如温度、压力、圆周速度)，则建议提前作测试。在标准条件下所进行的实际测试可提供相应密封件的最佳适用信息。介质制造商的实验室测试和咨询同样可以提供帮助。

当密封腐蚀性介质时，材质为 FKM 的 WA/WAS 比材质为 NBR 的适用范围更广。由 FKM 制成的旋转油封耐化学性和抗热性更强。

另外，材质为 FKM 的旋转油封 WA/WAS，标配 1.4301 (SAE 304) 防锈耐酸预紧弹簧同时其金属骨架完全被 FKM 橡胶包覆。

如果需要耐受更强的介质，可选择带有 PTFE 密封唇的 WCP21 型或完全由 PTFE 制成的 WEPO 密封。

常用介质：矿物基油和油脂

一般而言，由 NBR 和 FKM 标准材料制成的密封件适用于这些介质。对于多种成分的介质，因无经验值可参考，建议先进行测试。

合成油和油脂

合成润滑剂的特性主要由它的基油和大量添加剂决定。NBR 材料可适用于有少量添加成分的润滑油。若添加成分很多，尤其温度在 +80°C 以上，则推荐使用 FKM。

然而由于合成润滑剂由大量添加成分构成，可能会出现密封件不耐介质的问题。因此，我们建议通过测试提前验证材料的适用性。

旋转油封材料的应用

材料	NBR	FKM	HNBR	NBR	NBR	NBR	VMQ	ACM	PTFE
				高温	高温	低温			
低温 [°C]	-40	-30	-40	-30	-30	-50	-50	-25	-80
高温 [°C] (无介质影响)	100	200	150	100	120	90	200	150	200
耐磨性	2	1-2	1-2	2	2	2	3	3	3

待密封介质/允许持续温度 [°C]

矿物油

发动机油	100	150	100	100	120	90	130	130	150
齿轮油	80	150	80	80	100	70	130	120	150
准双曲面齿轮油	80	140	80	80	100	70	-	120	150
ATF油	100	150	100	100	110	80	■	130	150
符合DIN 51524标准的液压介质	90	130	90	90	100	80	■	120	150
EL和L燃料油	90	150	80	90	90	■	■	■	150
油脂	90	150	90	90	100	80	■	120	150

抗燃液压介质 VDMA 24317 / 24320

HFA水包油乳化液	60	■	60	60	60	■	■	-	■
HFB油包水乳化液	60	■	60	60	60	■	■	-	■
HFC聚合物水溶液	60	-	60	60	60	■	■	-	■
HFD非水性合成液	-	150	-	-	-	-	■	-	150

其他介质

水	80	80	90	80	80	■	■	-	■
肥皂水	80	80	90	80	80		■	■	■

所列出的高温值是指密封唇处的最高温度。该温度可高于介质温度+40°C以上，具体取决于应用情况。

1 = 优秀 / 2 = 良好 / 3 = 一般

■ = 耐介质,但不常用

■ = 耐介质性有限

- = 不耐介质

安装座孔

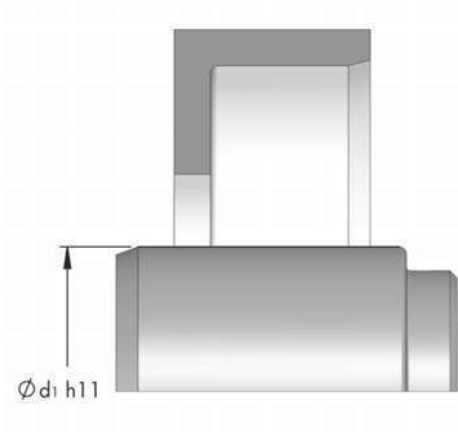

旋转轴

除旋转油封外，旋转轴也是旋转密封系统的一个关键机械元件，因此为确保良好的密封效果，必须满足一系列技术要求。

对于旋转密封系统的寿命和密封功能，与旋转油封的密封唇口相接触的旋转轴表面设计非常重要。

公差

为确保必要的预紧力，与旋转油封的密封唇口相接触的旋转轴表面直径 d_1 采用符合 DIN ISO 286 标准下的 h_{11} 公差。轴的圆度公差为 IT 8。

旋转轴表面光洁度

按长度测量的表面粗糙度应在下述范围内：

$$R_a = 0.2 \sim 0.8 \mu\text{m}$$

$$R_z = 1.0 \sim 4.0 \mu\text{m}$$

$$R_{\max} \leq 6.3 \mu\text{m}$$

如果轴表面过于光滑 ($R_a < 0.2 \mu\text{m}$) 且圆周速度过快，则会发生故障。这会导致密封唇口的润滑供给受到阻碍，密封唇口处的润滑膜破裂，密封唇口会产生热损坏。过于粗糙的轴表面会导致密封唇口过早磨损。这两种情况均会导致严重的泄漏。

如果旋转轴有轴向移动，为确保良好的密封效果，应遵循以下粗糙度要求：

$$R_a \leq 0.2 \mu\text{m}$$

$$R_z \leq 0.8 \mu\text{m}$$

旋转轴表面硬度

密封点的寿命还取决于旋转轴接触表面的表面硬度。表面硬度至少应为 45HRC。

如果有外部污染介质或灰尘进入，且圆周速度大于或等于 4m/s，轴表面硬度必须至少达到 55 HRC~60 HRC。

如果表面硬化处理，则其硬化深度需至少为 0.3mm。

需对镀铬、镀镉、氮化和磷化处理的轴表面进行特殊加工处理。根据不同的适用性，要采用不同的处理方式。氮化处理后，要使灰质层变得平滑。对于镀铬轴表面，随后的横磨将决定润滑油膜的形成。

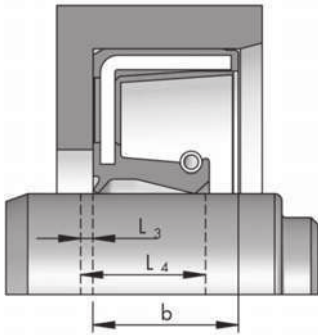
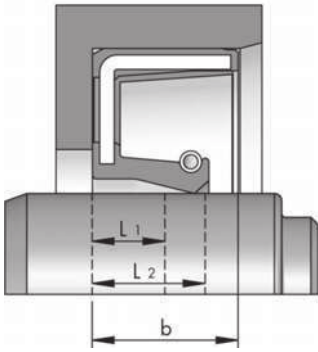

接触表面区

在下表列出的接触表面区内的表面光洁度和表面硬度要完全遵循本样本先前列出的要求。接触表面区由密封件宽度 b 决定。

b	L_1 min.	L_2 min.	L_3 min.	L_4 min.
7	3.5	6.1	1.5	7.6
8	3.5	6.8	1.5	8.3
10	4.5	8.5	2	10.5
12	5	10	2	12
15	6	12	3	15
20	9	16.5	3	19.5

旋转轴表面的加工

与密封唇口接触的轴表面应为圆形且无螺旋线，从而确保密封点不会发生由于进给或泵吸作用而产生的泄漏。接触表面的正确加工对密封功能来说极为重要。

处理方法如下：

横磨

由于横模（研磨时砂轮无轴向进给）可以确保滑动表面完全没有螺旋线，因此它是最常用的加工方法。为提高效率，无火花磨削时间必须为 30 秒。使用多颗粒砂轮修整器对砂轮进行修磨以确保不出现螺旋线。在磨削期间，尽量避免轴转速（如 50 1/min）和砂轮转速（例如 1500 1/min）之间的整数速比。

硬态车削

进行硬态车削时，为加工出可用的滑动表面，必须遵循特殊的工艺参数，如进给、切削速度、切削深度和切削材料。选择该种加工方法是因为其具有高成本效益。其它优势包括：

- 一次安装便可完成全部加工。
- 准备时间短
- 生产步骤少
- 无切屑需处理
- 精确界定的轴表面结构

车削加工的轴在一个方向上会有明显的进给效果，即加工处理刻痕（螺纹）。它就像一个微螺纹使得油向一个方向进给。

进给方向取决于轴的旋转方向。选择旋转油封时，如果轴的旋转方向发生改变，该轴的进给方向必须能够与密封方向相反。由于这种原因，硬态切削仅能应用于单向旋转的旋转轴（轴的进给朝向充油腔）或者要选用一个旋转油封，该密封可以由硬态切削轴产生的进给油重新导入到充油腔。旋转油封的摩擦转矩与磨削轴的转矩相当。

德克迈特德氏封 (Dichtomatik) 在一家著名的科学研究所对不同旋转油封作了多项测试。为保证最大可能的功能可靠性，我们强烈建议通过试运转来检验密封件的适用性。关于工艺参数或试运转等更多信息，请联系德克迈特德氏封 (Dichtomatik) 研发部。

变薄旋压

深冲薄板

其他方法包括研磨、珩磨、金刚砂磨削、铰削、喷磨。这些方法可为旋转油封制造精度有限的滑面。一定要通过充分的试运转来检查此类滑面。

旋转轴表面无进给

旋转轴接触表面区必须无进给，以确保密封处无进给或泵吸效应，上述效应会影响旋转油封的机构功能并且导致泄漏。无进给意味着加工痕迹无方向诸如明显的微螺纹。

可使用螺纹法测试轴和轴套测试是否无进给。为保证测试结果的准确性，必须测试多个参数，如螺纹接触角度、转速和重量等。

测试时，当测试螺纹在湿润无进给接触面进行滑动时其轴向轨迹不会有任何变化。如果接触面有进给，根据不同的转向，测试螺纹会在轴向向左或右移动。



旋转轴表面进给测量设备“螺纹法”

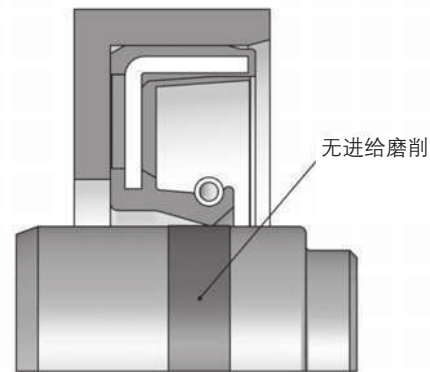

旋转轴材料

如果表面硬度值满足要求，一般的回火钢就适合作为旋转轴材料使用。

要避免在旋转油封接触区域形成腐蚀，在密封水或水基介质时要使用经过热处理、高合金、不锈钢制成的旋转轴。对于低转速以及辅助应用，也可使用有色金属。

铸铁材料有时也适合作为轴材料使用，但需无砂眼且气孔直径 $< 0.05\text{mm}$ 。

在特殊情况下，陶瓷镀层也可作为轴材料使用，但需对表面进行密封且陶瓷气孔直径 $< 0.05\text{mm}$ 。此外，须确保其表面光洁度满足要求以及镀层与基础轴材料粘合良好。

由于硬镀铬轴的润滑膜形成较困难且会出现偏心磨损，因此硬镀铬轴的适用性相当有限。仅可通过横磨来改善润滑膜的形成。

塑料轴的适用性也相当有限。由于塑料的热导系数极低，因此削弱了轴的散热能力，这样就会大幅增加了密封唇口处的温度。当转速达到或高于某特定转速时，塑料会软化或融化。

所有轴表面材料均应满足所需要的表面光洁度和硬度。

如果因经济、设计或技术制造原因而无法制造出轴所需的接触表面性能，可使用轴套。德克迈特德氏封 (Dichtomatik) 所提供的轴套包含所有尺寸，由各种材料制成，这些均由我司研发部设计完成。

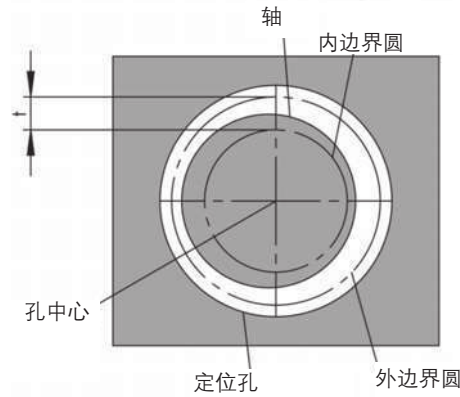
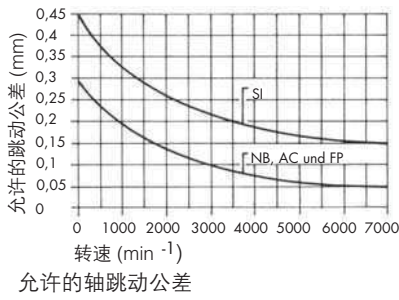

不圆度公差说明

不圆度

旋转轴的动态偏心和不圆度公差需保持在较小范围内。否则,在高转速下,密封唇可能会因惯性作用而脱离旋转轴。如果密封唇口和轴之间出现较大空隙,则密封介质会流出而引发泄漏。因此,建议将旋转轴密封布置在紧邻于轴承的位置同时尽可能减小轴承的窜动。依照转速的不同,可允许的不圆度值如左图所示。

由于耐压密封 WAY/WASY 的密封唇口较硬该数值应该更小。

轴径 d_1	安装倒角 d_3
<10	$d_1 - 1.5$
10 < 20	$d_1 - 2$
20 < 30	$d_1 - 2.5$
30 < 40	$d_1 - 3$
40 < 50	$d_1 - 3.5$
50 < 70	$d_1 - 4$
70 < 95	$d_1 - 4.5$
95 < 130	$d_1 - 5.5$
130 < 240	$d_1 - 7$
240 < 500	$d_1 - 11$

轴上的倒角

建议采用以下两种轴肩设计:

轴安装方向 Z 处:

轴肩圆角 $r_1 = 0.6 \sim 1$ 毫米。

轴安装方向 Y 处:

轴肩需要倒角,推荐角度 $15^\circ \sim 25^\circ$ 。

倒角直径 d_3 列于左边表格中。

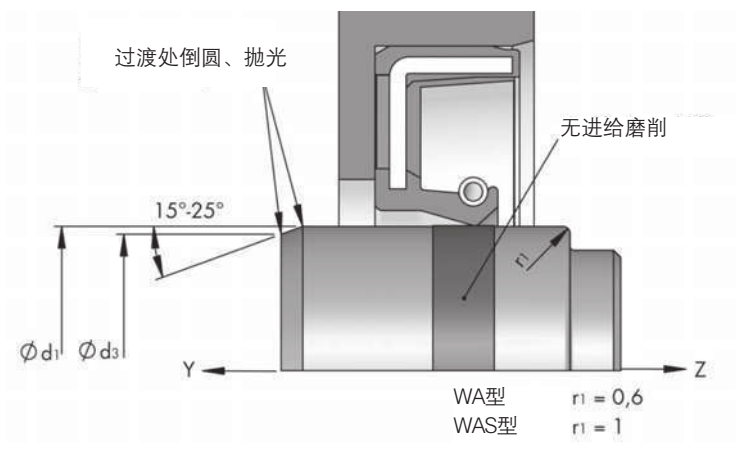

旋转轴缺陷

必须避免旋转轴接触表面出现刻痕、刮痕、压痕、砂眼、孔或腐蚀等缺陷。这将导致旋转轴过早损坏并出现泄漏。此类现象有 30% 是由不正确的旋转轴处理或缺陷引起。因此,从生产到最后的安装,均须小心保护。可使用特别运输装置或特制塑料模套或塑料滑套。

安装座孔

安装座孔的设计非常重要，因为旋转油封的外缘会与座孔壁产生静态密封以防止该位置的泄露（第二条泄露途径）。为确保旋转油封在座孔内的紧密配合，座孔的设计必须遵循以下技术要求：

公差

为获得良好的静密封性，座孔直径 d_2 采用 DIN ISO 286 标准下的 ISO 公差 H8，同时旋转油封外缘采用过盈配合。

座孔尺寸

根据不同的旋转油封高度 b ，所对应的座孔尺寸和固定圆角半径请见下表：

b	t_1 min.	t_2 min.	r_2
7	5.95	7.3	0.5
8	6.8	8.3	0.5
10	8.5	10.3	0.5
12	10.3	12.3	0.7
15	12.75	15.3	0.7
20	17	20.3	0.7

座孔上的倒角

为了顺利安装旋转油封，座孔应有 $10^\circ \sim 20^\circ$ 的倒角，同时确保过渡处无毛刺。

座孔表面光洁度

为确保座孔和旋转油封外缘的良好静密封性和安装的稳固性，其表面应符合下述粗糙度值：

外包金属骨架 WA 型：

$$R_a = 1.6 \sim 6.3 \mu\text{m}$$

$$R_z = 10 \sim 20 \mu\text{m}$$

$$R_{\text{max}} \leq 25 \mu\text{m}$$

外露金属骨架 WB 和 WC 型：

$$R_a = 0.8 \sim 3.2 \mu\text{m}$$

$$R_z = 6.3 \sim 16 \mu\text{m}$$

$$R_{\text{max}} \leq 16 \mu\text{m}$$

使用外露金属骨架旋转油封或者被用于密封液体或气体时，安装座孔的表面质量应良好，即无损坏且无任何加工痕迹（刮痕、刻痕、砂眼、和凹痕等）。

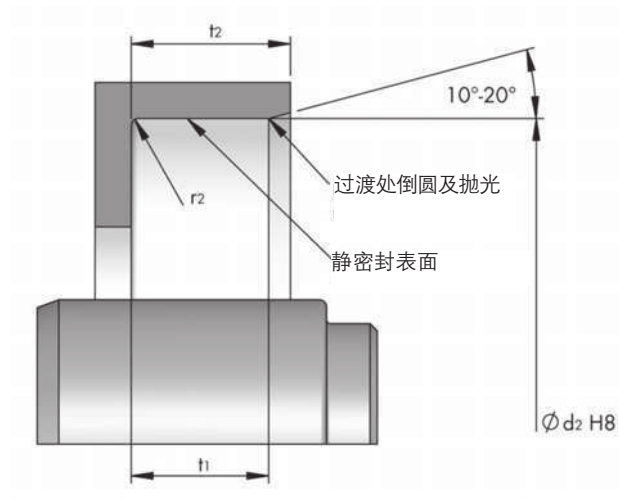

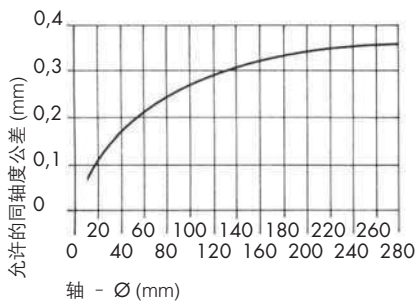

安装座孔和旋转轴之间允许的同轴度公差

安装座孔内的同轴度公差

安装座孔和旋转轴 / 轴承位置之间允许的同轴度公差 T_m (同心度偏差) 如旁边的表格所示。同轴度会导致接触压力在圆周上的不均匀分布。这样一方面会引起密封唇口处的压力过大, 从而导致过早磨损。另一方面, 它会使密封外缘与旋转轴接触压力过小从而导致密封功能下降, 产生泄漏。

应注意的是, 密封唇越短 (耐压型 Y/SY) 所要求的允许值越小。若使用特殊的弹性体、更加有弹性的密封唇或更长的密封唇, 可以提高同轴度公差。应尽量减小同轴度偏差值, 以确保径向力 / 线性压力的平均分布。

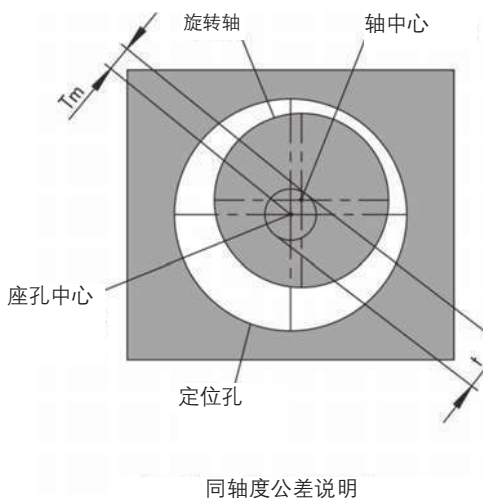

安装座孔材料

下列材料适用于旋转油封的座孔和座孔盖 / 法兰:

- 机械工程中常见的钢和可热处理钢
- 铸铁材料, 如 GGG, GG, GS, GTS
- 有色金属和有色金属合金, 如 G-ALMg
- 塑料, 如热塑性塑料和硬塑料

由于上述材料的散热系数变化差异很大, 因此在选择旋转油封型号和座孔材料时, 必须考虑散热系数。

热膨胀

旋转油封和座孔材料的热膨胀现象 (热膨胀系数) 对座孔内的静密封效果 (第二条泄漏路径) 极其重要。工作过程中, 可能出现大幅温度变化, 从而造成不同材料发生不同的线性尺寸变化。可使用线性扩展有效法则来计算线性尺寸变化:

$$\Delta L = \alpha \cdot \Delta T \cdot L_0 \text{ [mm]}$$

钢、铸铁材料、有色金属、塑料 (热塑料) 和弹性体热膨胀系数的变化有时很大, 会引发各种问题。如果是有色金属或者塑料的座孔内安装有外露金属骨架密封, 当温度上升时, 会因为不同的热膨胀系数, 导致预紧力下降, 密封件可能会被挤出。此种情况下, 建议使用橡胶外包的旋转油封 (如 WA 型)。

此类型的旋转油封因膨胀系数高, 因此具有更大的过盈配合度, 能更好地随座孔膨胀而膨胀。

带有卸油槽的橡胶外包旋转油封 (WAK 型) 有更高的过盈配合度, 能够覆盖更大的空隙。由钢或铸铁材料制成的座孔配以橡胶外包的旋转油封, 从热度方面来讲表现最佳。

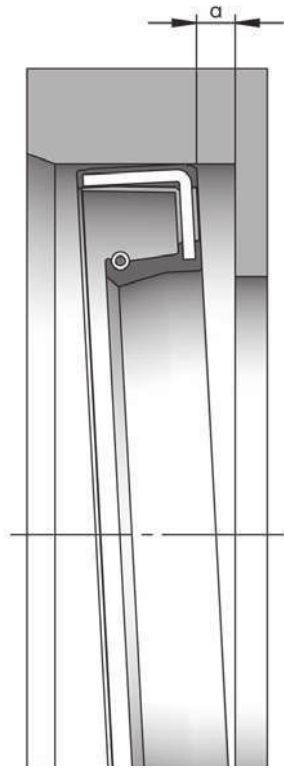

斜交说明

允许的倾斜

已安装的旋转油封应尽可能与轴保持垂直和对中。右倾角公差 au (DIN3761) 不应超过右侧表格中的数值。较大偏差(倾斜)会产生泵吸作用,对密封功能起到负面影响。此外,粗糙的轴表面会使密封唇单边过度磨损。

轴直径/mm

右倾角公差/mm

达到25	0.1
25 - 80	0.2
80以上	0.3

刚度

从经济因素考虑,安装座孔的壁厚通常非常薄。在薄壁座孔或低稳定性的安装壳体内安装旋转油封时,安装座孔有可能被撑大,从而导致泄漏。因此,为保证座孔内的静密性,需选择正确的旋转油封类型来尽可能将安装座孔的膨胀值控制在有限的范围内。

建议使用橡胶外包的旋转油封(如WA型)或使用更大的座孔公差。

剖分式安装座孔

由于弹性体具有良好的弹性形变和塑模填充能力,在剖分式安装座孔内使用WA型(橡胶外包)密封仍可以在剖分线处获得良好的静态密封性。

安装

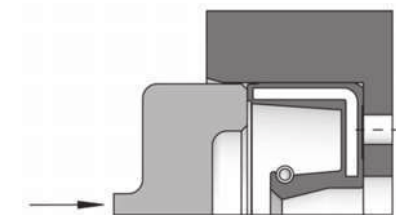
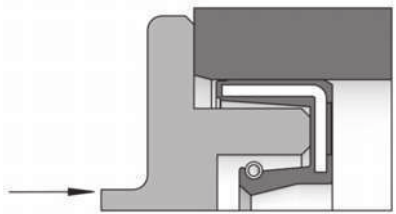
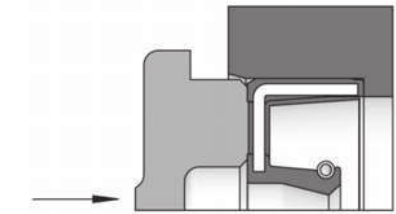
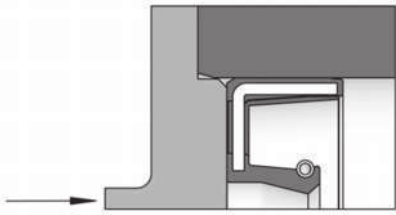

用于旋转油封的多种安装工具

正确安装相当重要。旋转油封约 30% 的故障和损坏问题是由不正确的安装或使用不恰当的安装工具造成的。旋转油封的安装需根据 DIN 3760 标准进行。

安装前，应小心清理安装区域和旋转油封。此外，粘附的脏颗粒也可能在运转不久后导致泄漏。同时也请遵循第 25 页的安装指南。

最好使用液压或机械压入设备将旋转油封压入座孔。这样能罩住旋转油封外部大片区域，使施加的压力尽可能靠近外径。确保将压入工具在密封压入到最后位置后保持一段时间。这样可以将旋转油封的回弹或倾斜降到最低。

如果旋转油封不得不越过尖锐边缘（如槽、螺纹或轴末端），则需使用适当的安装轴套。轴套不可有任何缺陷，如刮痕或粗糙表面。

为保证安装的牢固性，必须确保旋转油封的外缘与座孔内部配合面完全贴合。如果旋转油封外缘的前倒角稍微大于座孔内配合面的倒角，这将会减少配合比例从而引起旋转油封在座孔内“徘徊”。如果主密封唇和保护唇之间需要填充油脂，则需使用特定的工具。这些工具（如刷子）会在密封件内遗留残留物从而导致密封功能受损。油脂需填充 30 ~ 40% 的空间。

WCP21

该图显示了 WCP21 的安装。为了在倒角轴上安装 WCP21，应使用安装锥套来引导密封唇，使其不会出现折叠。

当 WCP21 外部端面首先压入安装时，旋转轴必须进行倒角或磨圆处理。同时还要依照旋转油封的通用安装指南进行安装。

$\varnothing d_1$	$\varnothing d_k$
6 - 60	$\varnothing d_1 - 3.5$
65 - 135	$\varnothing d_1 - 4.5$
140 - 170	$\varnothing d_1 - 6$

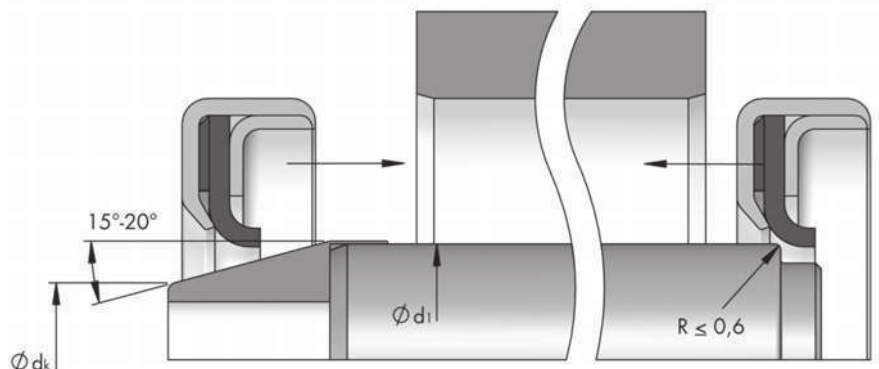

安装锥套 WCP21

特殊应用

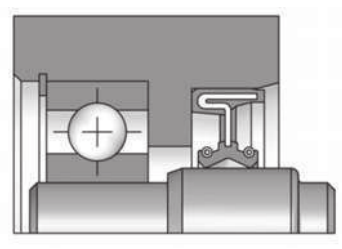
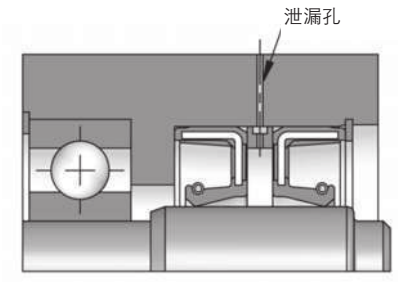
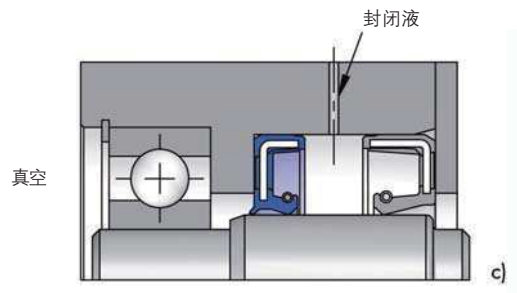
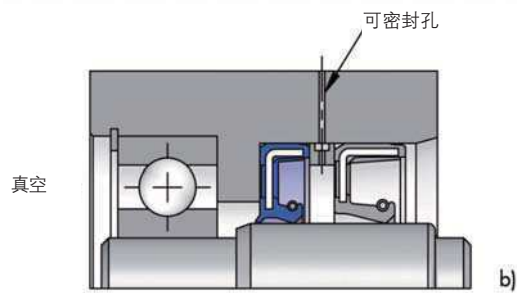
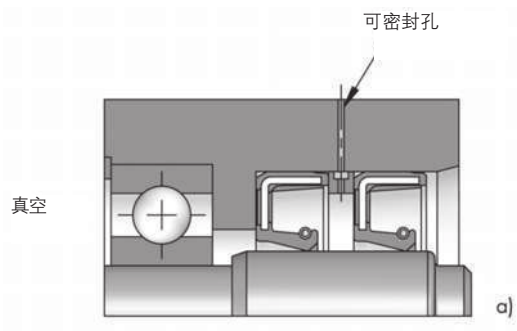

针对负压力或真空的密封

在负压力作用下密封时，旋转油封空气端的密封唇与压力梯度保持一致。在密封油脂时，其外侧使用的密封的密封腔体要朝向空气侧。图片 a) 和 b)

为确保密封唇的润滑和密封作用，应在两个旋转油封之间使用封闭介质。如果使用的是液体封闭介质，则在安装旋转油封时，两个密封的密封腔体要相对安装。由于负压力梯度的关系，封闭介质会增加内侧密封件的的压力。在此建议使用我们的 WAY/WASY 型。图片 c)

分离两种介质

为分离包含不同介质的两个区域，使用两个“背对背”旋转油封，即密封腔体以相反方向安装。建议在两个旋转油封之间的空间内设置一个泄漏孔。另一种分离两个介质的方法是在低圆周转速下使用我们的 WAD 型密封，WAD 型密封的一个密封包含两个“背对背”的密封唇。安装时用油脂来填充两个密封唇之间的空间。

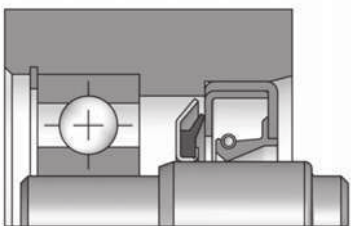
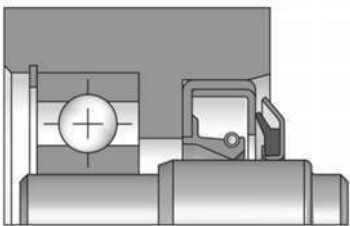
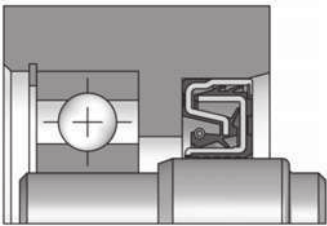
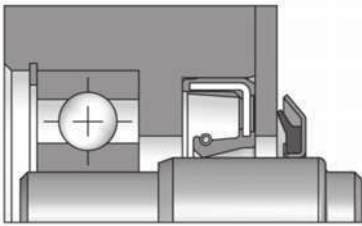
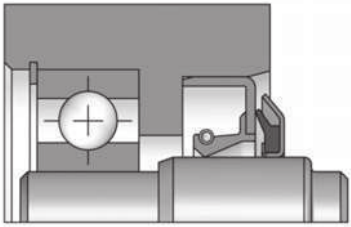

密封过量的外部灰尘

外部灰尘会导致旋转密封和轴表面过早磨损，应根据密封类型和灰尘量对密封唇进行保护。

最简单的解决方法是使用 WAS 型密封，该型号具有保护副唇。在安装期间，应使用油脂来填充密封唇和保护副唇之间 30 ~ 40% 的空间。

如果外部灰尘过多，则可用 VRM 轴向密封串联使用。VRM 与旋转轴一同旋转，直接将灰尘挡出。此外，VRM 的密封唇可对轴向安装座孔表面进行密封（可直接与旋转油封 WB 型相接触安装）。

在极端条件下（如农用和建筑机器），使用盒式密封。这种密封件完全密封后，在内部形成由几个保护唇所形成的充满油脂的空间。通过这种方式可有效防止灰尘侵入。盒式密封内也包含完全预处理过的密封接触面。

密封受污染介质

受污染介质或带有磨损物的介质会造成密封区域出现大量磨损。尤其是对于垂直轴，较低的密封件极易受沉淀颗粒的影响。串联使用第二个密封件或使用我们的轴向密封 VRM（可以与旋转油封 WC 型相接触安装）能解决这个问题。

弹性体密封件的储存

一般来说,弹性体密封件适于存放。如特性未发生变化,它们可保存多年,但需遵循与存放条件相关的一些最低要求。这些要求在 DIN 7716 和 ISO 2230 标准中均有提及。

密封件必须存放在无压力条件下,即没有拉紧、压力或其他形式使其发生形变。

密封件应远离过度通风处,尤其是通风机。建议封装存放,如使用聚乙烯袋或密封容器。

存放位置应保持凉爽、干燥、无尘,并适度通风。

最好保持恒定的存放温度。存放温度应保持在 -10°C 和 $+20^{\circ}\text{C}$ 之间。

禁止在存放室内放置加热器,加热器距离存货至少要有 1 米的距离。

相对湿度不能超过 65%。应避免强光,尤其是 UV 射线和阳光直射。

禁止在存放弹性体的室内放置会产生臭氧的电气设备。



径向油封
概览

产品系列



型号	温度 (°C)	速度 (m/s)	材料	尺寸 米	英寸
WA	-40 +100	12	NBR 70/ 钢骨架环 DIN EN 10139 标准 钢弹簧 DIN EN 10270-1 标准	■	■
WAS	-40 +100	12	NBR 70/ 钢骨架环 DIN EN 10139 标准 钢弹簧 DIN EN 10270-1 标准	■	■
WA FKM	-30 +200	35	FKM 80/ 钢骨架环 DIN EN 10139 标准 钢弹簧 DIN EN 1.4301 标准	■	■
WAS FKM	-30 +200	35	FKM 80/ 钢骨架环 DIN EN 10139 标准 钢弹簧 DIN EN 1.4301 标准	■	■
WB	-40 +100	12	FKM 80/ 钢骨架环 DIN EN 10139 标准 钢弹簧 DIN EN 1.4301 标准	■	■
WBS	-40 +100	12	NBR 70/ 钢骨架环 DIN EN 10139 标准 钢弹簧 DIN EN 10270-1 标准	■	■
WC	-40 +100	12	NBR 70/ 钢骨架环 DIN EN 10139 标准 钢弹簧 DIN EN 10270-1 标准	■	■
WCS	-40 +100	12	NBR 70/ 钢骨架环 DIN EN 10139 标准 钢弹簧 DIN EN 10270-1 标准	■	■
WAO	-40 +100	6	BR 70/ 钢骨架环 DIN EN 10139 标准	■	■
WAOK*	-40 +100	6	NBR 70/ 钢骨架环 DIN EN 10139 标准	■	■
WBO	-40 +100	6	NBR 70/ 钢骨架环 DIN EN 10139 标准	■	■
WAK*	-40 +100	12	NBR 70/ 钢骨架环 DIN EN 10139 标准 钢弹簧 DIN EN 10270-1 标准	■	■
WAG*	-40 +100	12	NBR 70/ 钢骨架环 DIN EN 10139 标准 钢弹簧 DIN EN 10270-1 标准	■	■
WAK FKM*	-30 +200	35	FKM 80/ 钢骨架环 DIN EN 10139 标准 钢弹簧 DIN EN 10270-1 标准	■	■
WAG FKM*	-30 +200	35	FKM 80/ 钢骨架环 DIN EN 10139 标准 钢弹簧 DIN EN 10270-1 标准	■	■
WAY	-40 +100	12	NBR 80/ 钢骨架环 DIN EN 10139 标准 钢弹簧 DIN EN 10270-1 标准	■	■

* 波纹外缘



径向油封
概览

产品系列



型号	温度 (°C)	速度 (m/s)	材料	尺寸 米	英寸
WASY	-40 +100	12	使用有限元法模拟座孔的静密封	■	■
WAY FKM	-30 +170	35	FKM 80/ 钢骨架环 DIN EN 10139 标准 钢弹簧 DIN EN 10270-1 标准		
WASY FKM	-30 +170	35	FKM 80/ 钢骨架环 DIN EN 10139 标准 钢弹簧 DIN EN 10270-1 标准	■	■
WAX	-40 +100	10	NBR 70/ 钢骨架环 DIN EN 10139 标准 钢弹簧 DIN EN 10270-1 标准		
WAD	-40 +100	6	NBR 70/ 钢骨架环 DIN EN 10139 标准 钢弹簧 DIN EN 10270-1 标准	■	■
WBD	-40 +100	6	NBR 70/ 钢骨架环 DIN EN 10139 标准 钢弹簧 DIN EN 10270-1 标准		
WCP 21	-90 +250	40	PTFE/ 玻璃纤维 /MOS2 钢 1.4401	■	■
WCL	-40 +100 -30 +200	12/15	NBR 70/FKM 75/ DIN EN 420 标准	■	■
WE5	-30 +100 -20 +180	20/25	NBR 80/FKM 80/ 织物 / 钢弹簧 1.4310	■	■
WE6	-30 +100 -20 +180	20/25	NBR 80/FKM 80/ 织物 / 钢弹簧 1.4310	■	■
WE7	-30 +100 -20 +180	20/25	NBR 80/FKM 80/ 织物 / 钢弹簧 1.4310	■	■
WEPO	-20 +205	15	PTFE/ 碳 / 石墨 / 钢弹簧 1.4571	■	■



轴向密封 概览

产品系列

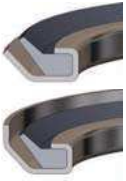

型号	温度 (°C)	速度 (m/s)	材料	尺寸 米 英寸
VRM 01	-40 +100 -30 +180	12	NBR 70/FKM 70/ 钢 1.0204	■
VRM 02	-40 +100 -30 +180	12	NBR 70/FKM 70/ 钢 1.0204	■

V形圈



型号	温度 (°C)	速度 (m/s)	材料	尺寸 米 英寸
VA	-40 +100 -20 +200	8 6,5	NBR 60/FKM 60 FKM 70	■
VS	-40 +100 -20 +200	8 6,5	NBR 60/FKM 60	■
VL	-40 +100 -20 +200	8 6,5	NBR 60/FKM 60	■
VE	-40 +100 -20 +200	8 6,5	NBR 60/FKM 60	■

盒式密封



型号	温度 (°C)	速度 (m/s)	材料	尺寸 米 英寸
C			NBR 70/FKM 80	

端盖



型号	温度 (°C)	速度 (m/s)	材料	尺寸 米 英寸
VER 01	-30 +100 -20 +200		NBR 70/FKM 70/ 钢 1.0204	■
VER 02	-30 +100 -20 +200		NBR 70/FKM 70/ 钢 1.0204	■
VER 03	-30 +100 -20 +200		NBR 70/FKM 70/ 钢 1.0204	■

轴修复套



型号	温度 (°C)	速度 (m/s)	材料	尺寸 米 英寸
WSH R			钢 1.4301	■ ■

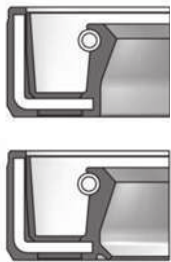

WA/WAS

根据DIN 3760标准设计，橡胶外缘内包金属骨架，弹簧加强橡胶密封唇。空气侧可配有防尘唇（WAS）。

产品描述

产品组	旋转油封
设计型号	A = 橡胶外缘
形式	S = 防尘唇
密封材料	NBR 70 3412 NBR 70 7504
颜色	黑色
金属骨架	非合金钢(DIN EN 10139)
弹簧	非合金弹簧钢(DIN EN 10270-1)

应用范围

密封旋转机械元件，如旋转轴、轮毂和轮轴。

功能

WA/WAS型是用于密封旋转轴的单作用密封件。WAS的防尘唇在空气侧可防止外部尘埃进入。橡胶外缘具有良好的静态密封性和良好的热膨胀平衡作用。

例如对于轻金属轴承座以及剖分式轴承座，当其粗糙度越大，其密封性能越好。同时还可以确保密封低粘度或气态介质时良好的静态密封性。

工作介质

耐多种矿物油和油脂。请参阅本目录第24页的耐介质表。

工作条件

压力(Mpa/bar): $\leq 0.05/0.5$

温度(°C): $-40 \sim +100$

圆周速度(m/s): ≤ 12

请参阅本目录第22页的圆周速度表。

安装

应使用合适的工具进行安装。建议需要安装的座孔能为旋转油封提供轴向支撑。请参阅本目录第32页的通用安装说明。

备注

我们可提供其他尺寸和不同设计，例如双防尘唇、螺旋密封唇、不同钢品级制成的弹簧和金属骨架，以及各种特殊设计。非标尺寸订购需达到最小起订量。

Any Seal. Any time.

您可登陆www.dichtomatik.de对所有现有数据进行查询。

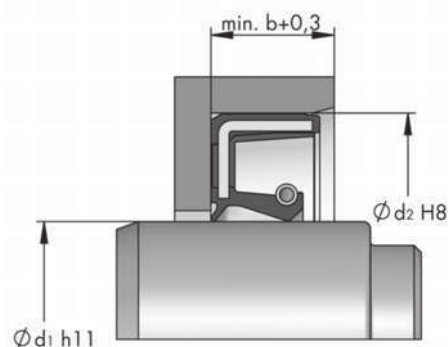
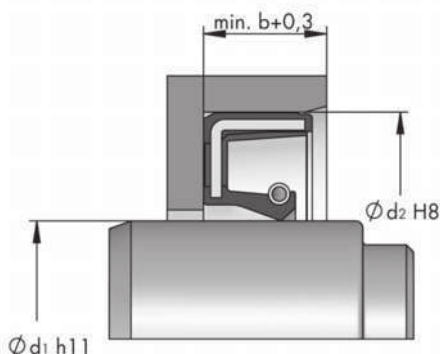

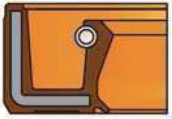
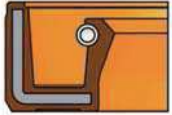

WA FKM/WAS FKM

根据 DIN 3760 标准设计，橡胶外缘内包金属骨架，弹簧加强橡胶密封唇。空气侧可配有防尘唇（WAS FKM）。

产品描述

产品组 旋转油封
设计型号 A = 橡胶外缘
形式 S = 防尘唇
密封材料 FKM 80 3403
颜色 棕色
金属骨架 非合金钢 (DIN E10139)
弹簧 不锈钢 1.4301 (SAE 304)

应用范围

密封旋转机械元件，如轴杆、轮毂和轮轴。

功能

WA/WAS 型是用于密封旋转轴的单作用密封件。WAS 的防尘唇在空气侧可防止外部尘埃进入。橡胶外缘具有良好的静态密封性和良好的热膨胀平衡作用。

例如对于轻金属轴承座以及剖分式轴承座，当其粗糙度越大，其密封性能越好。同时还可以确保密封低粘度或气态介质时良好的静态密封性。较 NBR 而言，FKM 耐更高的温度、承受更快的速度和耐腐蚀性更强的介质。

FKM 橡胶全包覆金属骨架和不锈钢弹簧的旋转油封可应用于腐蚀性介质的密封。

工作介质

耐矿物油和油脂、合成油和油脂、发电机油、齿轮和 ATF 油、燃油、芳香烃和氯化烃、多数化学品和溶剂。请参见本目录第 24 页的耐介质表。

工作条件

压力 (Mpa/bar): $\leq 0.05/0.5$
温度 (°C): $-30 \sim +200$
圆周速度 (m/s): ≤ 35
请参阅本目录第 22 页的圆周速度表。

安装

应使用合适的工具进行安装。建议需要安装的座孔能为旋转油封件提供轴向支撑。请参阅本目录第 32 页的通用安装说明。

备注

我们可提供其他尺寸和不同设计，例如双防尘唇、螺旋密封唇、不同钢品级制成的弹簧和金属骨架，以及各种特殊设计。非标尺寸订购需达到最小起订量。

Any seal. Any time.

您可登陆 www.dichtomatik.de 对所有现有数据进行查询。

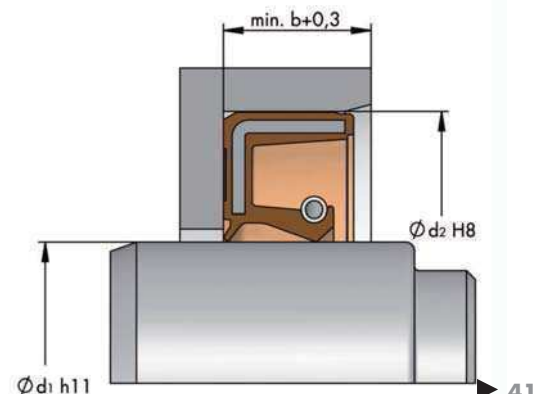
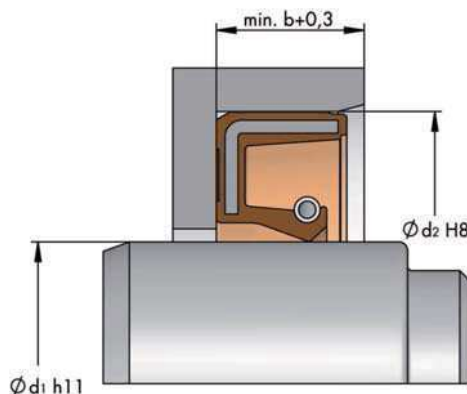

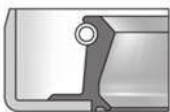

WB/WBS

标准旋转油封，外露金属骨架，弹簧加强橡胶密封唇。空气侧可配有防尘唇（WBS）。

产品描述

产品组	旋转油封
设计型号	B = 金属外缘
形式	S = 防尘唇
密封材料	NBR 70 3412 NBR 70 7504 NBR 70 4604
颜色	黑色
金属骨架	非合金 (DIN EN 10139)
弹簧	非合金弹簧钢 (DIN EN 10270-1)

应用范围

密封旋转机械元件，如轴杆、轮毂和轮轴。

功能

WB/WBS 型是用于密封旋转轴的单作用密封件。WBS 的防尘唇在空气侧可防止外部尘埃进入。金属外缘确保稳固和定位精准。

WB/WBS 在低粘度或气体介质环境中，或分体式座孔中，密封作用有限。

为确保外缘的静态密封效果，需更好的处理安装座孔表面或者在油封外缘表面涂漆。

工作介质

耐多种矿物油和油脂。请参阅本目录第 24 页的耐介质表。

工作条件

压力 (Mpa/bar): $\leq 0.05/0.5$

温度 (°C): $-40 \sim 100$

圆周速度 (m/s): ≤ 12

请参阅本目录第 22 页的圆周速度表。

安装

应使用合适的工具进行安装。建议需要安装的座孔能为旋转油封件提供轴向支撑。请参阅本目录第 32 页的通用安装说明。

备注

我们可提供其他尺寸和不同设计，例如双防尘唇、螺旋密封唇、不同钢品级制成的弹簧和金属骨架，以及各种特殊设计。非标尺寸订购需达到最小起订量。

Any seal. Any time.

您可登陆 www.dichtomatik.de 对所有现有数据进行查询。

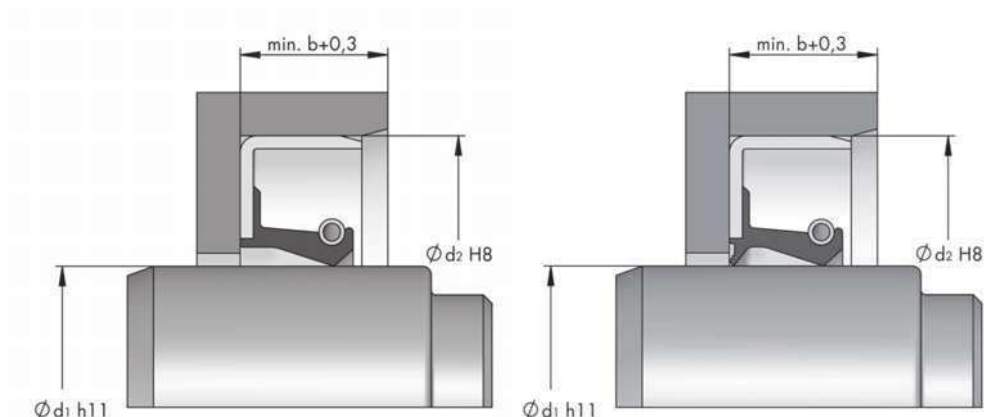

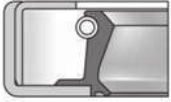
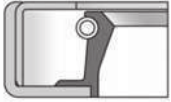

WC/WCS

标准旋转油封，金属外缘，侧面带有金属插片，弹簧加强橡胶密封唇。空气侧可配有防尘唇（WCS）。

产品描述

产品组 旋转油封
 设计型号 C = 金属外缘加金属插片
 形式 S = 防尘唇
 密封材料 NBR 70 3412
 NBR 70 7504
 NBR 70 4604
 颜色 黑色
 金属骨架 非合金钢(DINEN10139)
 弹簧 非合金弹簧钢
 (DINEN10270-1)

应用范围

重型工程、农用和林业机械、风能转换器和轧钢机。
 WC/WCS 型具有较大刚度，因此尤其适用于大型器件以及复杂的安装和恶劣的工况。

功能

WC/WCS 型是用于密封旋转轴的单作用密封件。WCS 的防尘唇在空气侧可防止外部尘埃进入。金属插片和金属外缘使其刚度大，安装更紧实、精准。

WC/WCS 在低粘度或气体介质环境中，或分体式座孔中，密封作用有限。

为确保外缘的静态密封效果，需更好的处理安装座孔表面或者在金属外缘表面涂漆。

工作介质

耐多种矿物油和油脂。请参阅本目录第 24 页的耐介质表。

工作条件

压力 (Mpa/bar): $\leq 0.05/0.5$
 温度 (°C): $-40 \sim 100$
 圆周速度 (m/s): ≤ 12
 请参阅本目录第 22 页的圆周速度表。

安装

应使用合适的工具进行安装。建议需要安装的座孔能为旋转油封提供轴向支撑。请参阅本目录第 32 页的通用安装说明。

备注

我们可提供其他尺寸和不同设计，例如双防尘唇、螺旋密封唇、不同钢品级制成的弹簧和金属骨架，以及各种特殊设计。WC/WCS 外缘也可涂漆。非标尺寸订购需达到最小起订量。

Any seal. Any time.

您可登陆 www.dichtomatik.de 对所有现有数据进行查询。

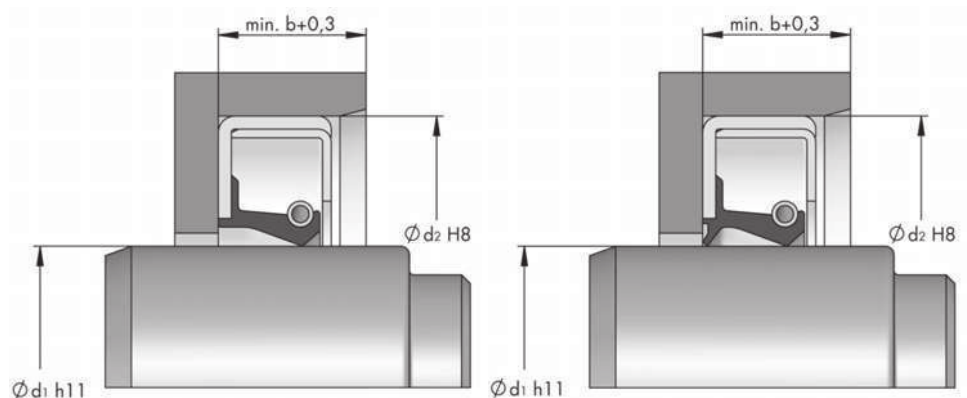

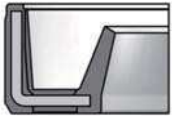

WAO/WBO/WAOK

标准旋转油封，波状橡胶外缘，内包金属骨架，橡胶唇口无弹簧。
WBO 型为金属外缘。

产品描述

产品组	旋转油封
设计型号	A = 橡胶外缘 B = 金属外缘
形式	O = 无弹簧 OK = 无弹簧、波状外缘
密封材料	NBR 70 3412
颜色	黑色
密封材料	NBR 70 3413
颜色	绿色
金属骨架	非合金钢(DIN EN10139)

应用范围

作为辅助密封，例如在电机内用作防尘、防污或防溅密封，如同集油器。

功能

WAO/WBO/WAOK 是用于密封旋转轴的单作用密封件。无弹簧密封唇所产生的摩擦较小。因此，与密封唇带有弹簧的旋转油封相比，其密封作用会下降。WAO/WAOK 型因为其是橡胶外缘，具有良好的静密封性和优秀的热膨胀平衡性例如对于轻金属轴承座以及剖分式轴承座，当其粗糙度越大，其密封性能越好。同时还可以确保密封低粘度或气态介质时良好的静态密封性。

WBO 型的金属外缘可确保紧实和精确定位。在低粘度或气体介质环境中，或分体式座孔中，密封作用有限。为确保高效静态密封效果，座孔表面必须经过良好处理。

工作介质

耐多种矿物油和油脂。
请参阅本目录第 24 页的耐介质表。

工作条件

压力 (Mpa/bar): 0/0
温度 (°C): -40 ~ 100
圆周速度 (m/s): ≤ 6
请参阅本目录第 22 页的圆周速度表。

安装

应使用合适的工具进行安装。建议需要安装的座孔能为旋转油封提供轴向支撑。请参阅本目录第 32 页的通用安装说明。

备注

我们可提供其他尺寸和不同设计，例如双防尘唇、螺旋密封唇、不同钢品级制成的弹簧和金属骨架，以及各种特殊设计。非标尺寸订购需达到最小起订量。

Any seal. Any time.

您可登陆 www.dichtomatik.de 对所有现有数据进行查询。

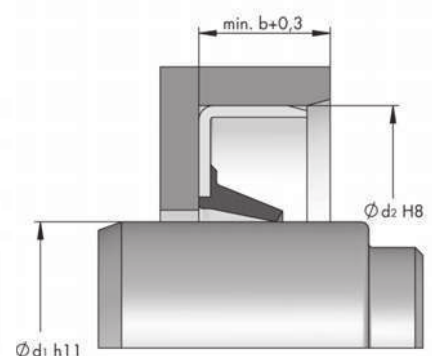
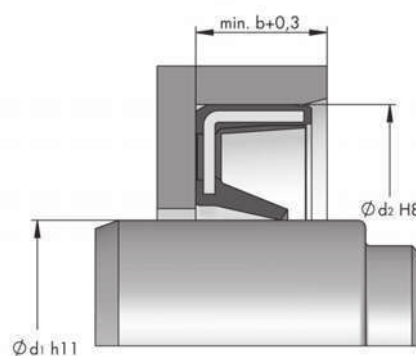
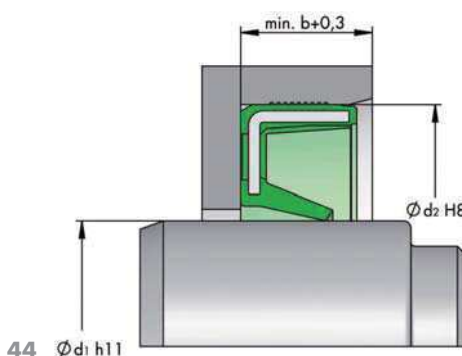

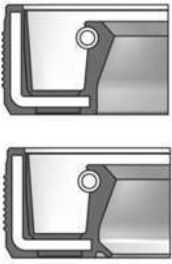

WAK/WAG

标准旋转油封，波状橡胶外缘，内包金属骨架，弹簧加强橡胶密封唇。空气侧可配有防尘唇（WAG）。

产品描述

产品组	旋转油封
设计型号	A = 橡胶外缘
形式	K = 波状外缘 G = 防尘唇和波状外缘
密封材料	NBR 70 3412
颜色	黑色
金属骨架	非合金钢 (DINEN10139)
弹簧	非合金弹簧钢 (DINEN 10270-1)

应用范围

密封旋转机械元件，如轴杆、轮毂和轮轴。

功能

WAK/WAG 型是用于密封旋转轴的单作用密封件。WAG 的防尘唇在空气侧可防止外部尘埃进入。由于具有波状外缘其与座孔内缘的静态密封配合可靠。还能防止油封本身的永久扭曲、变形。此外，由于需要较小的压入力便于安装。

工作介质

耐多种矿物油和油脂。
请参阅本目录第 24 页的耐介质表。

工作条件

压力 (Mpa/bar): $\leq 0.05/0.5$
温度 (°C): $-40 \sim 100$
圆周速度 (m/s): ≤ 12
请参阅本目录第 22 页的圆周速度表。

安装

应使用合适的工具进行安装。建议需要安装的座孔能为旋转油封提供轴向支撑。请参阅本目录第 32 页的通用安装说明。

备注

可按国家 / 国际标准定制外径达 600mm 的油封，订购有最小起订量要求。

我们可提供其他尺寸和不同设计，例如双防尘唇、螺旋密封唇、不同钢品级制成的弹簧和金属骨架，以及各种特殊设计。

Any seal. Any time.

您可登陆 www.dichtomatik.de 对所有现有数据进行查询。

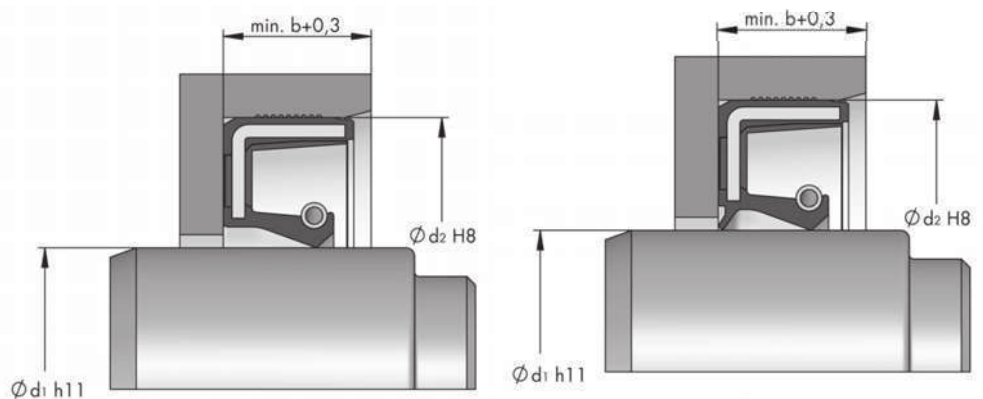

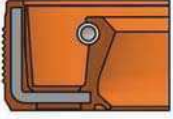

WAK FKM/WAG FKM

标准旋转油封，波状橡胶外缘，内包金属骨架，弹簧加强橡胶密封唇。空气侧可配有防尘唇（WAG FKM）。

产品描述

产品组 旋转油封
设计型号 A=橡胶外缘
形式 K=波状外缘
G=防尘唇和波状外缘

密封材料 FKM 80 3403
颜色 黑色
金属骨架 非合金钢(DIN EN10139)
弹簧 非合金弹簧钢
(DIN EN 10270-1)

应用范围

密封旋转机械元件，如轴杆、轮毂和轮轴。

功能

WAK FKM/WAG FKM 型是用于密封旋转轴的单作用密封件。WAG FKM 的防尘唇在空气侧可防止外部尘埃进入。由于具有波状外缘，其与座孔内缘的静态密封配合可靠。还能防止油封本身的永久扭曲、变形。此外，由于需要较小的压入力便于安装。

工作介质

耐矿物油和油脂、合成油和油脂、发电机油、齿轮和 ATF 油、燃油、芳香烃和氯化烃、多数化学品和溶剂。请参见本目录第 24 页的耐介质表。

工作条件

压力 (Mpa/bar): $\leq 0.05/0.5$
温度 (°C): $-30 \sim +200$
圆周速度 (m/s): ≤ 35
请参阅本目录第 22 页的圆周速度表。

安装

应使用合适的工具进行安装。建议需要安装的座孔能为旋转油封提供轴向支撑。请参阅本目录第 32 页的通用安装说明。

备注

可按国家 / 国际标准定制外径达 600mm 的油封，订购有最小起订量要求。

我们可提供其他尺寸和不同设计，例如双防尘唇、螺旋密封唇、不同钢品级制成的弹簧和金属骨架，以及各种特殊设计。

Any seal. Any time.

您可登陆 www.dichtomatik.de 对所有现有数据进行查询。

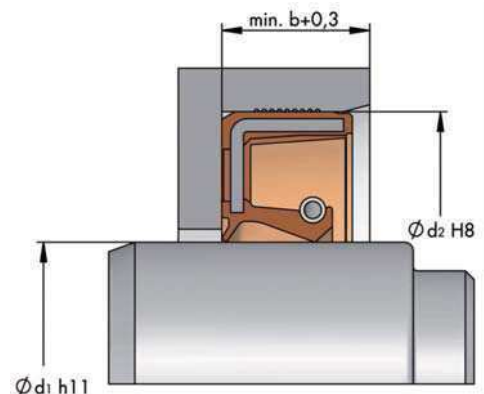
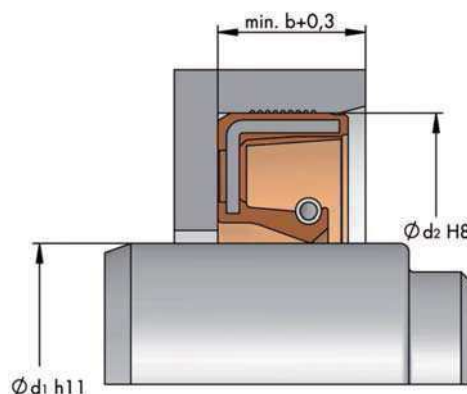

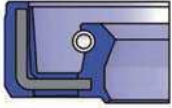
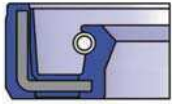

WAY/WASY

是 WA 耐压型旋转油封。该型号密封唇更短、更强劲。此外，空气侧可配有防尘唇（WASY）。

产品描述

产品组	旋转油封
设计型号	A=橡胶外缘
形式	Y=耐压型密封唇 SY=耐压型密封唇和防尘唇
密封材料	NBR 80 3404
颜色	黑色
密封材料	NBR 80 3414
颜色	蓝色
金属骨架	非合金钢(DIN EN 10139)
弹簧	非合金弹簧钢 (DIN EN 10270-1)

应用范围

在高压情况下密封旋转机械元件，如轴杆、轮毂和轮轴。
主要适用于带压力的系统，如泵和液压马达。

功能

WAY/WASY 型是用于密封旋转轴的单作用密封件。WASY 的防尘唇在空气侧可防止外部尘埃进入

更短、更厚实的弹簧加强密封唇能使其应用压力达到 10 bar（具体取决于转速）。

橡胶外缘具有良好的静态密封性和良好的热膨胀平衡作用。

例如对于轻金属轴承座以及剖分式轴承座，当其粗糙度越大，其密封性能越好。同时还可以确保密封低粘度或气态介质时良好的静态密封性。

工作介质

耐多种矿物油和油脂。
请参阅本目录第 24 页的耐介质表。

工作条件

压力 (Mpa/bar): ≤ 10 （具体取决于转速）
温度 (°C): $-40 \sim 100$
圆周速度 (m/s): ≤ 12
请参阅本目录第 22 页的圆周速度表。

安装

应使用合适的工具进行安装。建议需要安装的座孔能为旋转油封提供轴向支撑。请参阅本目录第 32 页的通用安装说明。

备注

我们可提供其他尺寸和不同设计，比如不同钢品级制成的弹簧和金属骨架，以及各种特殊设计。
非标尺寸订购需达到最小起订量。

Any seal. Any time.

您可登陆 www.dichtomatik.de 对所有现有数据进行查询。

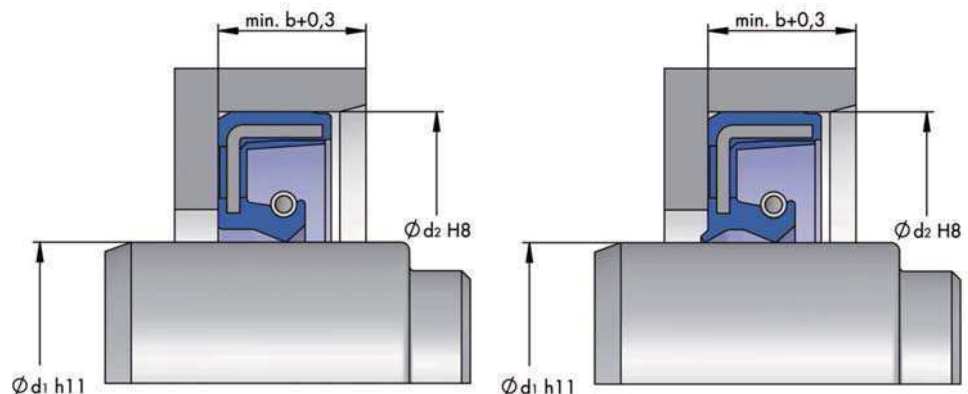

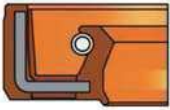
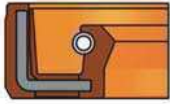

WAY FKM/WASY FKM

是 WA 耐压型旋转油封。该型号密封唇更短、更强劲。此外，空气侧可配有防尘唇 (WASY FKM)。

产品描述

产品组 旋转油封
 设计型号 A= 橡胶外缘
 形式 Y= 耐压型密封唇
 SY= 耐压型密封唇和防尘唇
 密封材料 FKM 80 3403
 颜色 棕色
 金属骨架 非合金钢 (DINEN10139)
 弹簧 非合金弹簧钢
 (DINEN 10270-1)

应用范围

在高压情况下密封旋转机械元件，如轴杆、轮毂和轮轴。
 主要适用于带压力的系统，如泵和液压马达。

功能

WAY/WASY FKM 型是用于密封旋转轴的单作用密封件。WASY FKM 的防尘唇在空气侧可防止外部尘埃进入

更短、更厚实的弹簧加强密封唇能使其应用压力达到 10 bar (具体取决于转速)。

橡胶外缘具有良好的静态密封性和良好的热膨胀平衡作用。

例如对于轻金属轴承座以及剖分式轴承座，当其粗糙度越大，其密封性能越好。同时还可以确保密封低粘度或气态介质时良好的静态密封性。

工作介质

耐矿物油和油脂、合成油和油脂、发电机油、齿轮和 ATF 油、燃油、芳香烃和氯化烃、多数化学品和溶剂。请参见本目录第 24 页的耐介质表。

工作条件

压力 (Mpa/bar): ≤ 10 (具体取决于转速)
 温度 (°C): $-30 \sim +170$
 圆周速度 (m/s): ≤ 35
 请参阅本目录第 22 页的圆周速度表。

安装

应使用合适的工具进行安装。建议需要安装的座孔能为旋转油封提供轴向支撑。请参阅本目录第 32 页的通用安装说明。

备注

我们可提供其他尺寸和不同设计，比如不同钢品级制成的弹簧和金属骨架，以及各种特殊设。
 非标尺寸订购需达到最小起订量。

Any seal. Any time.

您可登陆 www.dichtomatik.de 对所有现有数据进行查询。

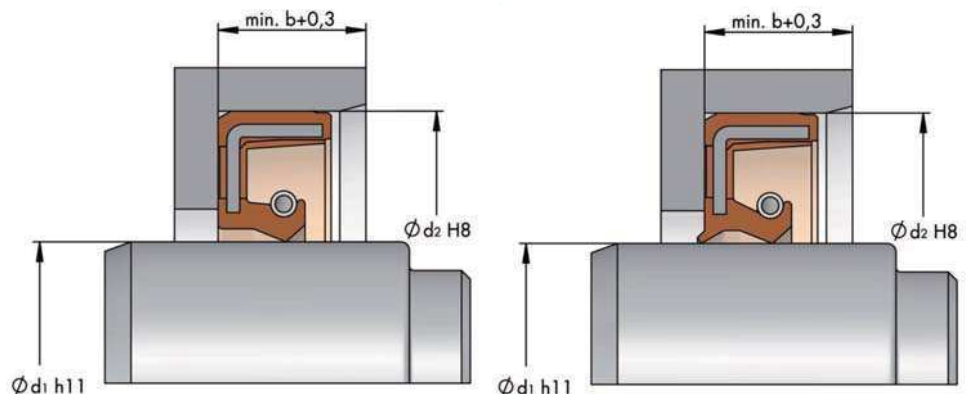



WAX

WAX 旋转油封是一种外部配有密封唇的特殊型号（内部密封）。该型号内有金属骨架和橡胶内缘以及外向型弹簧加强密封唇。

产品描述

产品组 旋转油封
设计型号 A=橡胶外缘
形式 X=外部密封唇
密封材料 NBR 70 3412
颜色 黑色
金属骨架 非合金钢（DIN EN 10139）
弹簧 非合金弹簧钢
（DIN EN 10270-1）

应用范围

对旋转机械部件进行密封，固定或旋转座孔，如农用和建筑机械内的轮轴密封。

功能

WAX 是用于静态密封或旋转轴的单作用密封件。

橡胶内缘具有良好的静态密封和热膨胀平衡作用。粗糙度越高，密封效果越好。适用于低粘度和气态介质的密封。

当离心力处于较高水平时，WAX 型的密封唇会被压出，从而增加摩擦和密封效果。

工作介质

耐多种矿物油和油脂。
请参阅本目录第 24 页的耐介质表。

工作条件

压力 (Mpa/bar): $\leq 0.05/0.5$
温度 (°C): $-40 \sim 100$
圆周速度 (m/s): ≤ 10
请参阅本目录第 22 页的圆周速度表。

安装座孔

安装座孔必须按照 DIN3760 的标准执行，表面质量须经良好处理。

安装

应使用合适的工具进行安装。建议需要安装的座孔能为旋转油封提供轴向支撑。请参阅本目录第 32 页的通用安装说明。

备注

可按国家 / 国际标准定制外径达 600mm 的油封，订购有最小起订量要求。

我们可提供其他尺寸和不同设计，例如防尘唇或不同钢品级制成的弹簧和金属骨架，以及各种特殊设计。

Any seal. Any time.

您可登陆 www.dichtomatik.de 对所有现有数据进行查询。

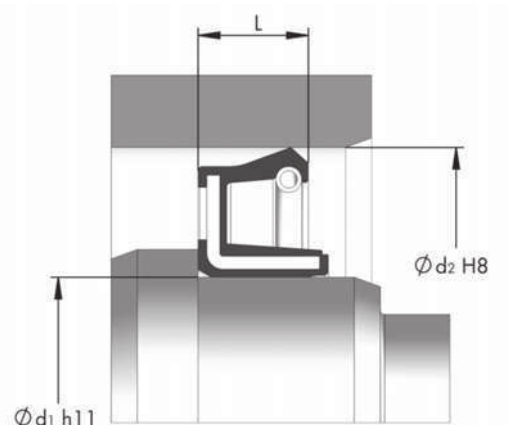

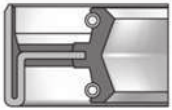
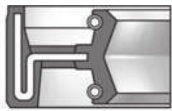

WAD/WBD

WAD, 橡胶外缘内包金属骨架, 2 个背靠背弹簧加强密封唇。WBD, 金属外缘, 2 个背靠背弹簧加强密封唇。

产品描述

产品组	旋转油封
设计型号	A=橡胶外缘 B=金属外缘
形式	D=外向型弹簧增强密封唇
密封材料	NBR 70 3412
颜色	黑色
金属骨架	非合金钢 (DIN EN 10139)
弹簧	非合金弹簧钢 (DIN EN 10270-1)

应用范围

密封旋转机械元件, 如轴杆、轮毂和轮轴。尤其适用于密封两种分开的介质或外部灰尘堆积严重。

功能

WAD/WBD 型旋转油封被应用于旋转轴或摆动轴系统中, 用来分隔两种介质或当外部有过多的灰尘时。

WAD 型是用于密封旋转轴的双作用密封件。橡胶外缘具有良好的静态密封和热膨胀平衡作用。粗糙度越高, 密封效果越好。剖分式座孔也能安全密封, 同样适用于低粘度和气态介质的密封。

WBD 金属外缘确保稳固和定位精准。

在低粘度介质、气体介质环境中, 以及剖分式轴承座中, 密封作用有限。

为保证外缘的高度静密封性, 座孔表面需做良好处理或者在密封金属外缘涂漆。

工作介质

耐多种矿物油和油脂。

工作条件

压力 (Mpa/bar): $\leq 0.03/0.3$

温度 (°C): $-40 \sim 100$

圆周速度 (m/s): ≤ 6

安装

应使用合适的工具进行安装。建议需要安装的座孔能为旋转油封提供轴向支撑。2 个密封唇之间的 2/3 空间需填充油脂。请参阅本目录第 32 页的通用安装说明。

备注

我们可提供其他尺寸和不同设计, 例如不同钢品级制成的弹簧和金属骨架, 以及各种特殊设计。

WAD/WBD 型也可选择 FKM 材料。

Any seal. Any time.

您可登陆 www.dichtomatik.de 对所有现有数据进行查询。

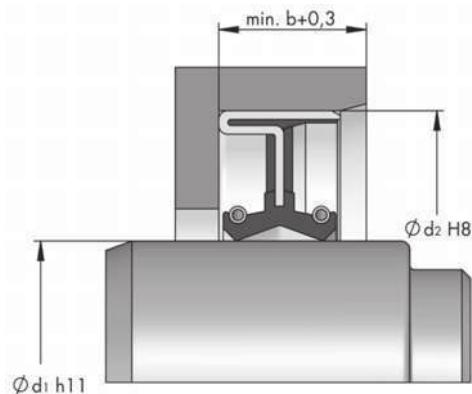
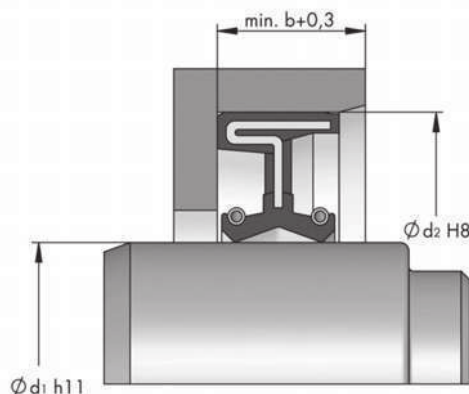

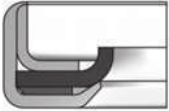

WCP 21

该旋转油封带有 PTFE 密封唇和夹紧在 2 个金属骨架之间的弹性体。非模压生产。

产品描述

产品组	旋转油封
设计型号	C= 金属外缘
形式	P=PTFE 密封唇
截面代码	21
密封材料	PTFE 00 3708 PTFE 00 1001
颜色	黑色
金属骨架	防锈耐酸钢 1.4401 (SAE 316)
弹性体	FKM

应用范围

在高圆周速度、高压力和 / 或高温下对旋转机械元件进行密封，诸如轴杆、轮毂和轮轴。

适用于密封腐蚀性介质。由于 PTFE 具有良好的摩擦系数，还可以用于干摩擦和润滑不良的场合。

功能

WCP21 是一种单作用旋转油封，用于密封旋转或摆动轴，使用寿命较长。PTFE 密封唇在轴上的接触压力保证了良好的密封性。同时 PTFE 材料极低的摩擦系数，是干摩擦或润滑不良场合的较好选择。由于具有较小的热扩展性，WCP21 可用于高圆周速度作业。该型号适用于较大的压力负荷，可选择 5/10/25 bar。金属外缘确保稳固和精准定位。

在低粘度介质、气体介质环境中，或分体式座孔中，密封作用有限。为保证外缘的高度静密封性，座孔的孔表面需做良好处理或者在密封金属外缘涂漆。

工作介质

耐所有类型的矿物油、水、水 / 油乳胶、热气以及几乎所有腐蚀性介质。

工作条件

压力 (Mpa/bar): SP1 5 bar / SP2 10 bar / SP3 25 bar
温度 (°C): -90 ~ 250
圆周速度 (m/s): $\leq 40 (p \times V)$

安装

通过压合使金属骨架的外径定位于座孔中心。安装座孔公差参照 DIN 3760 标准。应使用合适的工具进行安装。建议需要安装的座孔能为旋转油封提供轴向支撑。在安装期间，切勿损坏 PTFE 密封唇。鉴于此，建议使用安装锥。请参阅本目录第 32 页的通用安装说明。

备注

我们可提供其他尺寸和不同设计，例如不同钢品级制成的弹簧和金属骨架，以及各种特殊设计。

非模压生产，交期快，可小批量下单。

Any seal. Any time.

您可登陆 www.dichtomatik.de 对所有现有数据进行查询。

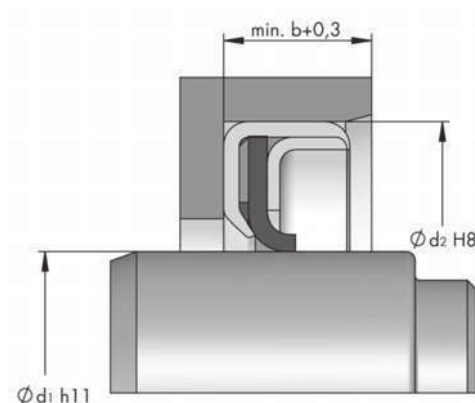

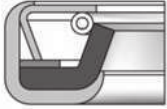

WCL/R

该旋转油封的弹簧加强橡胶密封唇在 2 个金属骨架之间，非模压生产。

产品描述

产品组	旋转油封
设计型号	C=金属外缘和金属加强环
形式	L=弹性体密封唇 R=防尘唇
密封材料	NBR 70 1001 FKM 75 1001
颜色	黑色
金属骨架	非合金钢(DIN EN 10139)
弹簧	非合金弹簧钢 (DIN EN 10270-1)

应用范围

在高压下对旋转机械元件进行密封，如轴杆、轮毂和轮轴。FKM 的密封唇使其非常耐化学介质和高温。WCL 刚性强，尤其适用于大型应用以及复杂的安装条件和恶劣的工况。

功能

WCL 是一种单作用旋转油封，用于密封旋转轴或摆动轴。弹性体密封唇和其具有预紧力的弹簧保证了良好的密封性。适用于高压负荷，可达 5/10 bar。附加的金属加强环可提供更好的刚性。金属外缘确保稳固和精准定位。在低粘度介质、气体介质环境中，或分体式座孔中，密封作用有限。

为保证外缘的高度静密封性，座孔孔表面需做良好处理或者在密封金属外缘涂漆。

工作介质

NBR: 耐多种矿物油和油脂。
FKM: 耐矿物油和油脂、合成油和油脂、发动机油、变压器和 ATF 油、燃油、芳香烃和氯化烃、多数化学品和溶剂。

请参见本目录第 24 页的耐介质表。

工作条件

压力 (Mpa/bar): 0.5/5
最高可达 1Mpa/10 bar
温度 (°C):
NBR -40 ~ +100
FKM -30 ~ +200
圆周速度 (m/s):
NBR ≤ 12, FKM ≤ 15

安装

通过压合使金属骨架的外径定位于座孔中心。安装座孔公差参照 DIN 3760 标准。应使用合适的工具进行安装。建议需要安装的座孔能为旋转油封提供轴向支撑。在安装期间，切勿损坏弹性密封唇。鉴于此，建议使用安装锥。请参阅本目录第 32 页的通用安装说明。

备注

我们可提供其他尺寸和不同设计，例如不同钢品级制成的弹簧和金属骨架，以及各种特殊设计。

非模压生产，交期快，可小批量下单。

Any seal. Any time.

您可登陆 www.dichtomatik.de 对所有现有数据进行查询。

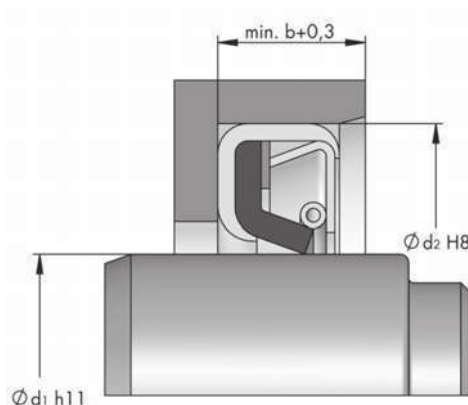

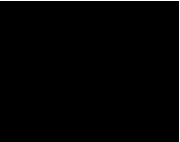
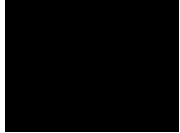

WE

该旋转油封外缘为橡胶夹布，弹簧加强密封唇。

产品描述

产品组	旋转油封
设计型号	E= 增强夹布织物和弹簧
截面代码	05/06/07
密封材料	NBR 80 FKM 80
外缘	NBR 80/FKM 80 棉夹织物
颜色	黑色
弹簧	防锈耐酸钢 1.4310 (SAE 302)

应用范围

在风力发动机、建筑机械、轧钢机械和造船厂等大型机械中对旋转机械元件进行密封，如轴杆、轮毂和轮轴。此外，在困难的安装条件下也可选用 WE 型密封。

功能

WE 型是一种用于旋转轴或摆动轴的旋转油封件。WE 05 型是标准型号。WE 06 型在 WE5 的结构基础上增加径向润滑槽。

WE 07 型在 WE5 的结构形式上增加径向润滑槽，又在外缘增加一条环形润滑槽。

在分离介质或防止灰尘、污物和水雾侵入情况下，当 WE06 和 WE07 型背对背配套时，需引入附加润滑以便润滑唇口。

WE 型具有高刚度的背部支撑、高径向接触压力以及良好的抗磨损性。

为便于安装，大尺寸 WE 可选择分割式，可用于内置轴的密封。

工作介质

NBR：耐多种矿物油和油脂。

FKM：耐矿物油和油脂、合成油和油脂、发动机油、变压器和 ATF 油、燃油、芳香烃和氯化烃、多数化学产品和溶剂。

请参见本目录第 24 页的耐介质表。

工作条件

NBR 80

压力 (Mpa/bar): 0.05/0.5

温度 (°C): -30 ~ 100

圆周速度 (m/s): ≤ 20

FKM 80

压力 (Mpa/bar): 0.05/0.5

温度 (°C): -20 ~ 180

圆周速度 (m/s): ≤ 25

安装

安装时应使用合适的工具。将 WE 型密封轴向轻轻塞入座孔内。如果 WE 高出一部分，则再将其轴向压入安装孔内。径向和轴向形变可以保证径向压力的增加。WE 06 和 WE 07 型均采用背对背安装，对于轴、座孔以及偏心有不同的要求。具体可致电我们技术部。

备注

我们可提供其他尺寸和不同钢品级制成的加强弹簧。

Any seal. Any time.

您可登陆 www.dichtomatik.de 对所有现有数据进行查询。

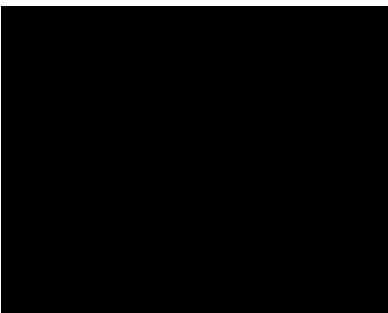

WE 05

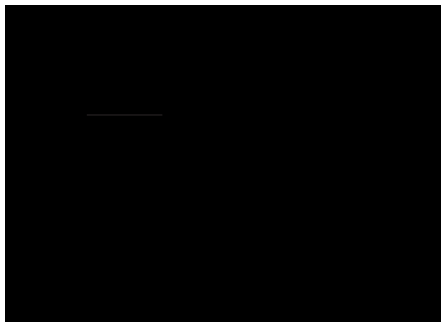

WE 06

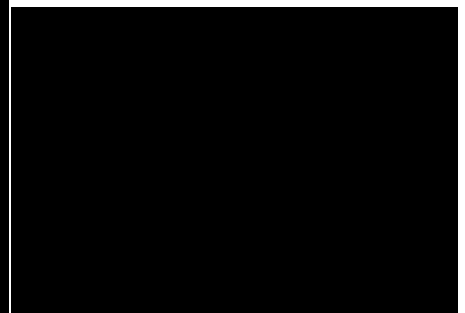

WE 07



WEPO

由 PTFE 制成的旋转油封，配有弹簧加强密封唇和起静态密封作用的 O 形圈。非模压生产。

产品描述

产品组	旋转油封
设计型号	EPO=WDR PTFE + O ring
密封材料	PTFE/ 碳 / 石墨 PTFE00 9809
颜色	黑色
O 形圈	FKM 80
弹簧	防锈耐酸钢 1.4571 (SAE 316Ti)

应用范围

用于密封旋转轴和摆动轴。该轴可能同时具有轴向往复运动和径向旋转运动。

功能

WEPO 是一种单作用旋转油封，使用寿命超长。经特殊设计的预紧弹簧能提供良好的动态密封。外缘上的 O 形圈具有双重功能：轴向密封和防止密封在座孔内旋转。由介质引起的 FKM O 形圈轻微膨胀对密封功能没有负面影响。

工作介质

耐所有类型的液压油、水和油乳胶以及几乎所有腐蚀性化学介质。

工作条件

压力 (MPa/bar): 1/10
温度 (°C): -20 ~ 205
圆周速度 (m/s): ≤ 15

轴表面硬度

轴表面硬度可选范围为 45–60 HRC，具体取决于介质的润滑特性和预期的污染物。在较高圆周速度下，表面硬度不应低于 55 HRC。轴表面必须无加工螺纹。

安装

PTFE 部件的外径以正公差生产，并通过压入定位于座孔中心。根据工作压力必须在非压力端采用轴向支撑。

备注

下页中列出的为标准尺寸。也可按需订购非标尺寸和其他 PTFE、不同等级钢制成的弹簧以及其他弹性体制成的 O 形圈。

Any seal. Any time.

您可登陆 www.dichtomatik.de 对所有现有数据进行查询。

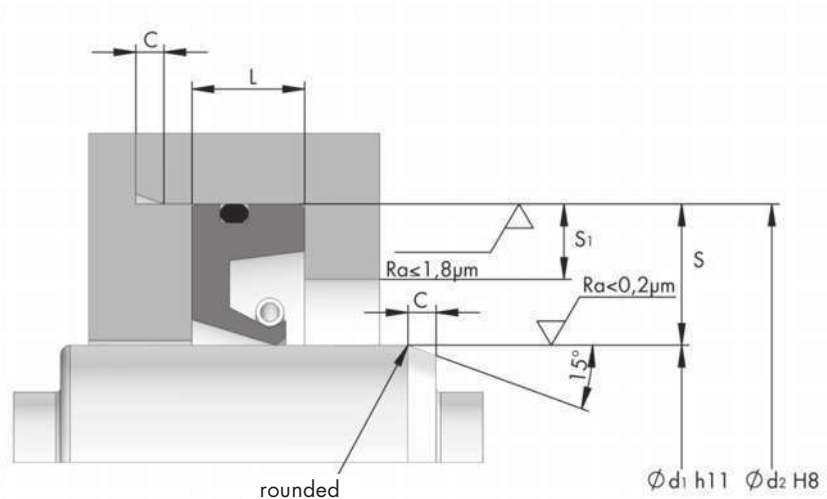

安装尺寸

序列号:

	001	002	003	004	005	006
$\varnothing d_1$ h11	6-45	45-65	65-85	85-125	125-200	200-300
$\varnothing d_2$ H8	d +9~ 35	d +12 ~ 35	d +15 ~ 35	d +19 ~ 35	d +20 ~ 35	d +30 ~ 40
L +0.2						
标准范围	7	8	10	12	15	15
非标准范围	5.5-10	6-12	7-13	8-15	9-20	10-25
C	2	2.5	3	3	4	4
S₁ 最小值	3	3	4	4	5	5

订购号示例

轴向密封件

产品组

截面代码

材料

VRM

01

NBR

VRM

02

FKM

轴向密封件

标准

加长型金属环

V形圈

产品组

设计型号

材料

V

A

NBR

V

S

FKM

V形圈

标准

加强型紧固元件

端盖

产品组

截面代码

材料

VER

01

NBR

VER

02

FKM

端盖

光滑的橡胶外缘涂层和部
分涂层的金属的加固环

光滑、部分涂覆橡胶外缘和
半肩设计

轴修复套

产品组

设计型号

材料

WSH

R

NG 304

轴修复套

维修

不锈钢 1.4301

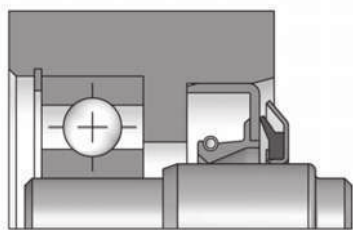
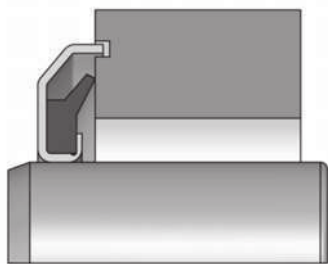
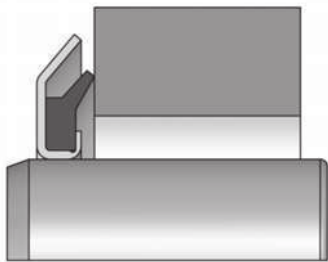

VRM 01/VRM 02

VRM 01 和 VRM 02 是轴向旋转密封件，包括两个部分：一个有镀层的金属壳体和—个硫化弹性体密封部件。

金属壳体可防止弹性体密封出现损坏，为弹性体提供支撑，同时作为护圈使用。弹性体密封未与金属壳体紧固粘接而是张紧在金属环上并被轴向法兰支撑着。

在 VRM 02 中，金属壳体在外护套上轴向延伸。该金属壳体与转动滑面上的环形沟槽形成了另一个迷宫式密封。

产品描述

产品组	轴向密封件
截面代码	01=标准型 02=金属壳体延长型
密封材料	NBR 70 3411
颜色	黑色
密封材料	FKM 70 3403
颜色	棕色
金属骨架	镀层金属 1.0204 (SAE 1008)
金属骨架	耐酸钢 1.4301 (SAE 304)

应用范围

VRM 轴向密封件主要与旋转油封串联组合使用，防尘、防污和防水。多年来，VRM 轴向密封件已成功应用于传动技术和机械工程，例如电机、变压器、泵、动力锯、后驱传动轴、轮毂和轮轴、农用机械、建设机械、机械工具、滚轴壳体和清洁机。

功能

VRM 轴向密封件与旋转轴配合紧密（过盈配合），并须准确与金属转动面保持规定的距离，以确保弹性体密封元件具有预定的紧力。

旋转运动时，在预设预紧力所产生的接触压力下，密封唇在金属转动面上轴向摩擦。以获得所需的密封功能。

总的轴向接触压力来自于安装座孔内的预应力、密封唇的几何形状以及弹性体的弹性和拉伸特性。

VRM 轴向密封件会产生离心力，从而起着良好的防尘、防污和防水的密封作用。

圆周速度不断增加时，弹性体密封元件会在离心力作用下被推出，从而降低接触压力。当圆周速度高于一定值时，密封唇会完全脱离金属转动面，这时 VRM 轴向密封件的作用仅为间隙密封和抛油环。

VRM 02 还具有迷宫式密封功能。为实现这种功能，接触转动面必须带有可供延长型金属环移动的凹槽。由于壳体内具有迷宫内凹槽，因此 VRM 02 能额外提供保护功能，能满足较高的应用要求。

VRM轴向密封件的优点

- 适用较窄的安装宽度
- 防油脂、防尘、防污和防飞溅水
- 金属壳离心作用带来额外的密封功能
- 能与旋转油封较好的配合使用
- 对密封面的表面质量要求较低
- 安装简单
- 金属壳可防止弹性体密封部分出现损坏
- 圆周速度在离心力作用下升高，从而减少摩擦
- 良好的动态密封效果
- 无需额外的轴向定位

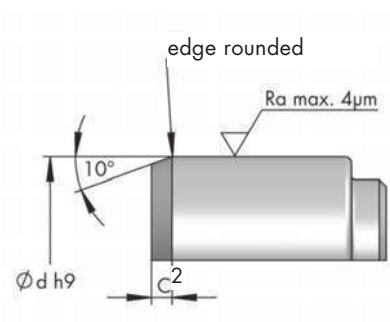
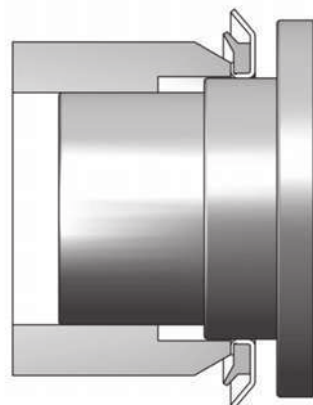
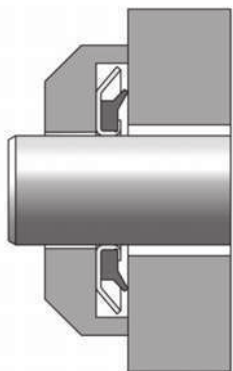
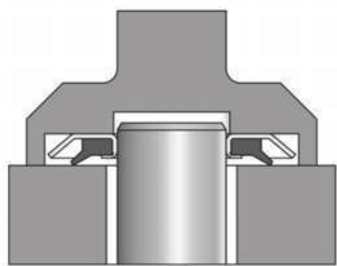

工作介质

NBR: 耐多种矿物油和油脂。

FKM: 耐矿物油和油脂、合成油和油脂、发动机油、变压器和 ATF 油、燃油、芳香烃和氯化烃、多种化学产品和溶剂。

请参见本目录第 24 页的耐介质表。

工作条件

圆周速度:

NBR ≤ 12 m/s, FKM ≤ 12 m/s,

温度:

NBR -40°C ~ +100°C

FKM -30°C ~ +180°C

压力: 针对无压操作设计

上述操作参数均为最大值, 不会同时出现。每个操作参数数值之间相互影响。

密封旋转配合面

VRM 轴向密封件在与旋转轴垂直的转动配合面上运动, 如法兰盖或轴承壳体侧壁。旋转油封(WB、WC 型) 的空气侧金属面常用作转动配合面。转动配合面的表面质量要求较低。

转动配合面应具有精加工的表面, 其质量应达 $Ra = 2 \mu m$ (可满足多数应用需求)。

预制注塑模或塑模轻金属合金零件以及重塑钢板也可用作旋转配合面, 无需额外处理。但旋转配合面不可有任何表面异常或缺陷, 如锐边、毛刺、空腔、折皱、隆起或损坏。

轴

轴的公差应遵循 ISO h9 (或符合 ISO g6 或 n6 的滚动轴承标准公差), 以保证获得所需的紧配合在轴上有准确稳固的定位, 无需再进行轴向固定。

为在安装时实现正确的弹性体密封预紧力, 建议使用轴肩或挡环进行轴向限位。

轴表面粗糙度不应超过 $Ra = 4 \mu m$ 。

轴应具有 $10-20^\circ$ 倒角, 以利于安装。应避免锐边和毛刺, 即过渡处应抛光。密封唇的密封配合面不应该高于 $Ra = 2 \mu m$ 。

与其他旋转密封件相比, VRM 轴向密封件相对于轴 - 孔偏心、轴偏斜和轴跳动不敏感。

安装

VRM 轴向密封件易于安装。在安装前弹性密封部分应涂润滑脂, 以改善动态摩擦系数, 从而确保有更长的使用寿命 (防止由摩擦造成的过度磨损)。这也可避免因长时间停止使用而出现的粘附现象。

应使用适当的安装工具和施加均匀的压力, 将 VRM 压入正确的安装位置。为避免损坏, 不可使用锤子来安装。如无台肩, 则必须使用合适的工具以维持预期的轴向预紧力。

存放时, 切勿损坏密封唇或使其变形。

Any seal. Any time.

您可登陆 www.dichtomatik.de 对所有现有数据进行查询。



VA



VS



VL



VE

V形圈

V形圈是模压弹性橡胶轴向密封件。由V形圈主体、柔性连接和密封唇组成。

产品描述

产品组	轴向密封件
设计型号	A=标准型 S = 加强型主体 L = 薄型 E = 大直径型
密封材料	NBR 603410 NBR 609202 NBR 605604 NBR 605601
颜色	黑色
密封材料	FKM 605601 FKM 603401 FKM 603402 FKM 603403 FKM 709203
颜色	棕色

应用范围

V形圈主要与其他类型的密封件配套使用，如旋转油封，用作轴承和轴的辅助密封元件，常用于传动技术、机械工程和工厂工程。V形圈也可用于电机、变压器、农用机械、轴承座和轧钢机。

该密封件可防止外部灰尘、污物、润滑剂、油或水雾侵入。对于极端工况条件下（如过度暴露在泥土和碎石中），我们建议使用VRM01和VRM02金属壳防护轴向密封件。

功能

V形圈可用作唇密封件，也可用作离心环。

V形圈通过拉伸安装到轴上且必须准确安装在指定的位置上，该位置与配合旋转金属表面保持一定距离，从而保证密封唇的轴向预紧力。轴承端面、轴承箱或轴肩可作为其配合旋转表面。

V形圈与轴一起旋转，并对其配合的旋转面进行轴向密封。

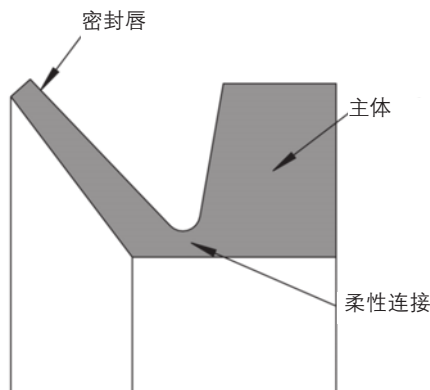



由于离心力的影响，唇口的接触压力随着速度提高而降低。
当圆周速度达到一定水平时，密封唇会完全脱离其配合旋转面。此时V形圈仅作为间隙密封件和离心环。

V形圈的优点

- 单作用密封元件
- 防尘、防污、防润滑剂、防油或防溅水
- 可与旋转油封件配合使用
- 对密封表面质量要求低
- 易于安装 - 通过拉伸安装到轴上
- 由于离心力作用，圆周速度上升，摩擦降低。
- 良好的动态密封效果
- 可以补偿轻微的轴向位移以及角度和旋转的轻微变化
- 在磨损工况下可保护旋转油封

对旋转摩擦面的要求

V形圈密封的摩擦面垂直于轴，如法兰盖或轴承壳侧壁。摩擦面应经过精心加工，其表面质量 $Ra=2.0$ (可满足大多数工况的应用需求)，无需硬化处理。在恶劣的工况条件下(如过多灰尘、大量泥土和细砂)，应选择最小硬度。在这种情况下，应根据待密封介质和摩擦面的材料来选择硬度(请参见表格)。

由注塑或铸造轻金属合金和成型钢板所制成的部件都可作为摩擦面，无需额外处理。但该表面光滑，无锐边、毛刺、气泡、波纹、鼓起或其他损坏。

工作介质

NBR: 耐多种润滑剂和矿物油。

FKM: 耐矿物油和润滑剂、发动机油、齿轮油、ATF油、燃油、芳香烃和氯化烃以及大部分化学物质。

工作条件

压力: 针对无压操作设计
温度 (°C):
NBR -40 ~ +100
FKM -20 ~ +200
圆周速度 (m/s):
NBR ≤ 8 ;
当 $\geq 8m$ 时需要轴向固定;
当 ≥ 12 时需要径向固定
FKM ≤ 6.5 ;
当 ≥ 6.5 时需要轴向固定;
当 ≥ 10 时需要径向固定

用于旋转摩擦面的材料

材料	建议硬度	介质
碳钢	125 - 150 HV	污泥、灰尘
铸铁	190 - 270 HV	污泥、灰尘
铸造青铜	100 - 160 HV	水、灰尘
注塑铝	90 - 160 HV	飞溅水
不锈钢	150 - 200 HV	水



轴

对于轴并无特殊要求，按照旋转油封的一般要求即可，如倒角、粗糙度等。

轴偏差约为 1° 时，密封功能不变。

根据 V 形圈尺寸的不同，有对应的允许偏心率。为了正确安装 V 形圈，必须参照下图表（偏心率图表）。

V形圈轴杆 \varnothing	偏心率
5-8	0.2
10-18	0.3
20-38	0.4
40-65	0.5
70-100	0.7
110-150	1.2
160-199	2
>200	4

安装

V 形圈易于安装。它可以通过在短时间内拉伸大到其原直径的 1.2 倍而安装在轴上。需要注意由锐边等对 V 形圈造成的损坏。

一般来说，弹性体适于存放。如特性未发生变化，它们可保存多年，但需遵循与存放条件相关的一些最低要求。这些要求在 DIN 7716 和 ISO 2230 标准中均有述及。

备注

以下几页述及的标称尺寸为标准尺寸。

Any seal. Any time.

您可登陆 www.dichtomatik.de 对所有现有数据进行查询。



盒式密封件

在 Dichtomatik 公司，盒式密封件是特殊型号，按需订制。

产品描述

产品组	盒式密封件
密封材料	NBR 70 FKM 80
颜色	黑色 棕色

应用范围

盒式密封件是高刚性和结实的密封系统。该密封件用于超重型应用和恶劣的环境，如商用汽车、材料加工设备以及农用、林业和建设机械。

常用于：

轮毂、支撑轴、轴承、驱动轴、轮轴。

功能

盒式密封件被完全包覆，且在内部形成带有多种密封件和防尘唇的油脂填充迷宫（径向和轴向）。主密封唇带弹簧，可有效地防止尘土、淤泥、水和灰尘侵入。油脂填充能减少磨损，增加使用寿命，从而延长重型应用的维修周期。盒式密封件自带接触面，因此轴不必进行特殊硬化和磨削处理，也无需额外的防尘密封。

工作介质

盒式密封件用于密封上述机械元件的油脂和油。

NBR 70 – 耐多种矿物油和油脂。

FKM 80 – 耐矿物油和油脂、合成油和油脂、发动机油、齿轮和 ATF 油、燃油、芳香烃和氯化烃、多种化学品以及溶剂。

安装

盒式密封件本身自成密封系统，包括摩擦面，易于安装。

Any seal. Any time.

您可登陆 www.dichtomatik.de 对所有现有数据进行查询。

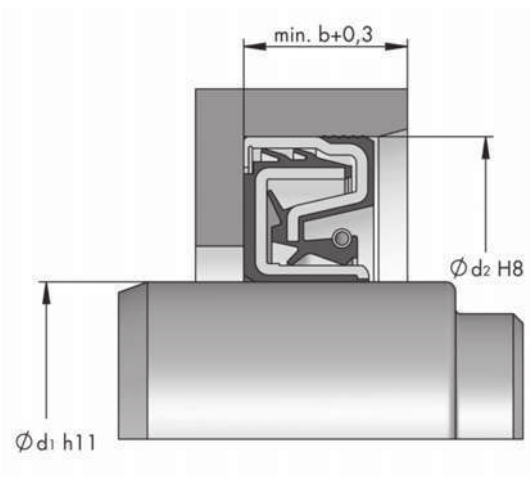



VER 01



VER 02



VER 03

端盖

产品描述

产品组	端盖
设计型号	01=橡胶体外缘 02 =半肩设计 03=波状橡胶外缘
密封材料	NBR 70 3412 NBR 70 0211
颜色	黑色
密封材料	FKM 70 3403
颜色	棕色
金属骨架	非合金钢 (DIN EN 10139)

应用范围

端盖密封件用于轴或轮轴的开孔处密封，常用于传动单元和轴承座。

特殊设计

任何特殊设计都可根据客户的要求定制。

功能

VER 01型

光滑的橡胶外缘能提供良好的静密封性。尤其适用于分体式和轻质金属座孔以及对低粘度液体和气体介质的密封。

VER 02型

该半肩设计结合了橡胶和金属外缘的优点，既能提供良好的静密封性，也能保证座孔内的精准、稳固定位。

VER 03型

波状橡胶外缘式所需的压入力较小，易于安装。波状设计可防止盖密封件出现永久性倾斜。

由于波状橡胶层外表面具有较高的压入公差，因此对于具有较大热膨胀的座孔它具有较好的适用性。

工作介质

NBR: 耐多种矿物油和润滑剂，抗介质老化。

FKM: 耐矿物油和润滑剂、合成油和润滑剂、发动机油、变压器油、ATF 油和燃油，以及多种化学介质和溶剂，非常耐臭氧，抗老化。

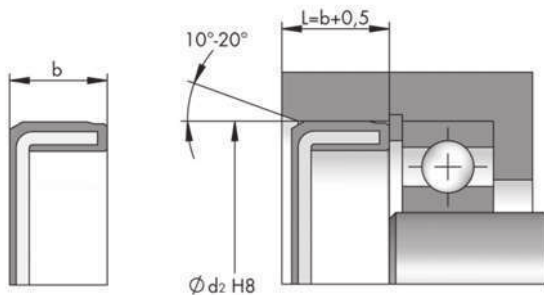

64 VER 01

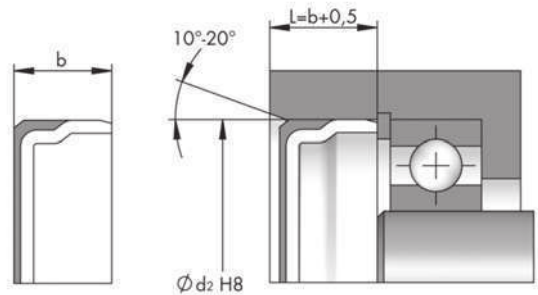

VER 02



设计注意事项

座孔的设计应遵循 DIN 3760 标准中对旋转轴密封件相应的要求。对于孔直径 d_2 ，可遵循 DIN ISO 286 的 ISOH8 公差。

应用范围

压力 (Mpa/bar): 0.05/0.5

在较大压力下，需要用卡簧来固定端盖密封件。

温度 (°C):

NBR: -30 ~ +100

FKM: -20 ~ +200

安装

确保正确的安装十分重要。最好使用液压或机械压力设备，将端盖密封压入座孔中。这些设备在端盖密封的外缘与其接触以确保压入力尽可能施加在端盖密封的外缘。要确保压力设备在达到最高设定值时保持一段时间。这将使密封盖的反弹作用或倾斜降到最低。

备注

以下几页述及的名义宽度代表标准尺寸。

Any seal. Any time.

您可登陆 www.dichtomatik.de 对所有现有数据进行查询。

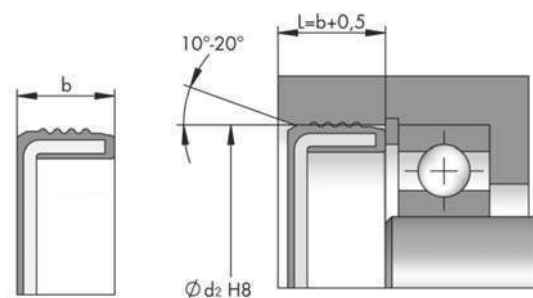

VER 03



轴修复套

标准件系列

产品描述

产品组 WSH
轴修复套
设计型号 R 维修
材料 不锈钢 1.4301 (AISI 304)

安装套

材料 碳钢 1.0330 (SAE 1008)

适用范围

轴套的使用温度，圆周速度，压力等参数取决于与之配合的旋转油封，一般来说，WSH R 适用于所有标准旋转油封。

技术参数

要获得长效的，良好的密封效果，轴套与旋转油封件接触的滑动面必须符合一系列的技术要求，这是整个密封系统中最重要的因素。

表面光洁度

/ 粗糙度值 $R_a = 0.2 \sim 0.8 \mu m$
 $R_z = 1 \sim 5 \mu m$
 $R_{max} \leq 6.3 \mu m$

表面处理 无进给磨削

表面硬度 HV 220 (95 HRB)
耐磨处理

壁厚 0.28 mm 薄壁设计

应用领域

与旋转油封接触的表面，容易磨损或者被混进密封面的异物磨出沟痕，WSH R 轴套用于修复此类损坏。例如，在变速箱应用上，相对于修复或直接更换轴，使用轴套修复不仅大幅度降低了维修费用，还缩短了维修时间和人力成本。如果沟痕较深，轴颈经过打磨修复之后，直径会明显缩小，因此需要更换内径更小的密封圈以保证密封件的过盈配合，但如果使用 WSH R 轴套，则可方便快捷的修复，既不需要对磨损的轴打磨修复，也不需要更换密封件的型号。

当然，WSH R 轴套不仅仅只用于维修，也可以用于原装设备的配套，特别是对于大型的复杂的机器设备、生产线等，可避免将来高昂的维修费用。



功能和优势

使用 WSH R 能使磨损部位的所有性能参数迅速恢复到磨损前的水平，并且拥有很长的使用寿命。

轴套与密封件唇口直接接触，发生相对摩擦，是整个密封系统中，除了密封件和润滑油脂外，最重要的部件。

WSH 轴修复套优势如下：

- > 含安装套，安装简易、快捷。
- > 修复成本低、无需拆卸和打磨轴颈。
- > 维修时间降到最低，节省宝贵的停机时间
- > 低成本维修方法。
- > 修复后性能完好如初，且持久性强。
- > 过盈配合压入，与轴配合紧固。
- > 最优的机加工和耐磨处理，确保长效使用寿命。
- > 无需更换原密封件尺寸规格。
- > 简化库存备件。

安装

配备了安装套和自身带有可拆卸法兰，WSH R 轴套的安装非常简单，省时。但是，也应认真对待，首先要确保轴套与轴的同轴性，以免发生损坏，从而影响轴套与密封件的配合，降低密封效果。接下来要仔细检查轴的安装表面，因为轴套的壁厚很薄，过盈配合使得轴表面上的任何不平整都可能会在轴套表面上形成相似的花纹，从而影响密封效果。因此，安装之前，需要锉掉所有毛刺和粗糙斑点。对于较深的沟痕，裂纹，刻画的标记等，要用金属粉末环氧填料填补，并且在填料硬化之前将轴套定位在轴上。轴套的安装不能逾越键槽，交叉孔，花键轴或螺纹等。

WSH R 轴套安装在已磨损的轴上，必须遵循以下步骤才能获得最佳效果。

旋转油封与WASH R 轴套的配合

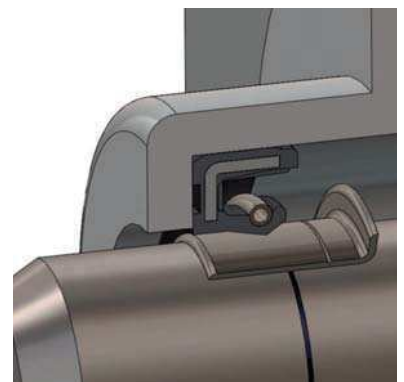
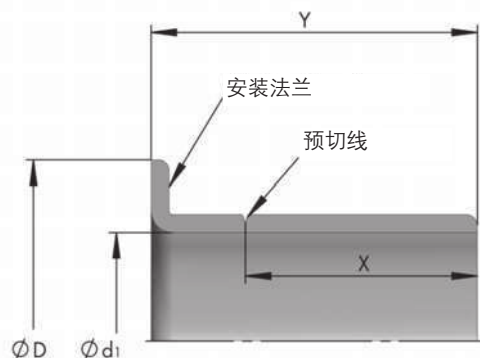

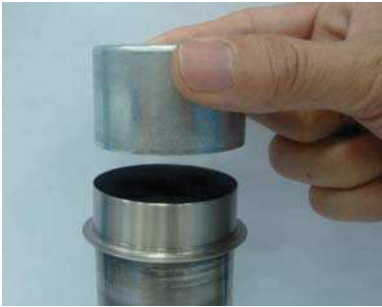
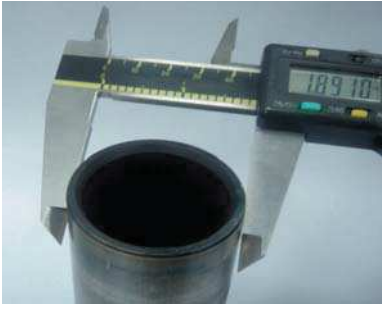

安装程序

1. 清洁磨损轴表面并去除所有毛刺。
2. 测量轴上未磨损部分的轴径。(如图所示)测量 2-3 个不同的点,取平均值,选择与之对应的 WSH R 轴套。
3. 安装前在轴的安装表面涂上一层薄薄的润滑脂(易于安装)。
4. 把 WSH R 轴套套在轴上,拆卸法兰一端先套入。(如图所示)。
5. 把安装套套上轴套,如果工装套不够长,可以使用直径相近的且两端切平的管子加长。
6. 用小锤子或者其他合适的工具轻轻敲打安装套中心,通过安装套把轴套推到安装部位,覆盖轴的磨损表面。
7. 如果安装后要拆下法兰,使用斜口钳按断点切入,沿预切线扯下法兰。
8. 安装后再次检查轴表面是否有毛刺。
9. 安装密封件前在轴套上涂上润滑脂。
10. 安装旋转油封。

拆卸步骤

WSH R 轴套的拆卸始终要注意不要损坏轴表面,可以通过以下几种方法拆卸:

- > 加热 - 轴套加热膨胀后可轻松的拆卸下来而不需破坏。
- > 用小锤子轻轻敲出。
- > 从断点处切入,用斜口钳将其撕下。
- > 用凿子或其他工具把轴套切开。

WSH R 轴套不能重复使用。

备注

内径 12 至 200 毫米的轴套单独包装,配备安装套,同时附多种语言的安装指导说明,常年库存有现货。

原则上,我们的 WSH R 轴套直径能做到 370 毫米,也可根据您的要求提供壁厚更厚和直径更大的轴套,欢迎垂询。

Any seal. Any time.

您可登陆 www.dichtomatik.de 对所有现有数据进行查询。



油封

尺寸



d1	d2	H	H2	产品编码	产品组	设计型号	形式	材质
2.3	12.7	6.4		131109	W	A	O	NBR
3	8	2		150044	W	B	O	NBR
3.18	12.7	6.4		131110	W	A	O	NBR
4	8	2		48935	W	B	O	FKM
4	8	2		166052	W	B	O	NBR
4	8	2		22037	W	A	OK	NBR
4	8	2		84122	W	B	O	NBR
4	10	6		128125	W	A		FKM
4	11	6		57025	W	A		NBR
4	11	6		73217	W	A		FKM
4	12	4		150919	W	A		FKM
4	12	6		24140	W	A		NBR
4	12	6		77494	W	A		FKM
4	12	6		42406	W	A		NBR
4.8	22	7		38808	W	A		NBR
5	9	2		22038	W	A	OK	NBR
5	9	2		160730	W	B	O	NBR
5	9	2		48936	W	B	O	FKM
5	9	2		89828	W	B	O	NBR
5	10	2		22039	W	A	OK	NBR
5	10	2		92830	W	B	O	NBR
5	11	3		134053	W	A	O	NBR
5	13	7		163220	W	A		FKM
5	13	7		64784	W	A		NBR
5	13	7		118986	W	A		NBR
5	15	5		38166	W	A	S	NBR
5	15	5		39257	W	A	OK	NBR
5	15	6		16758	W	A		NBR
5	15	6		20255	W	A		FKM
5	15	6		170016	W	C		NBR
5	15	6		39363	W	A		NBR
5	15	6		38836	W	A	S	NBR
5	15	7		18651	W	A		NBR
5	16	6		38432	W	A		NBR
5	16	6		18602	W	B		NBR
5	16	7		22550	W	A		FKM
5	16	7		38837	W	A	S	NBR
5	16	7		38809	W	A		NBR
5	18	7		34771	W	A		NBR
5	18	7		38838	W	A	S	NBR
5	19	5		27672	W	A	S	NBR
5	22	7		38839	W	A	S	NBR
5.5	13	4.5		163694	W	A		FKM
6	10	2		22040	W	A	OK	NBR
6	10	2		74145	W	B	O	NBR
6	10	2		166054	W	B	O	NBR
6	10	2		83774	W	B	O	FKM
6	10	2		84250	W	A	O	FKM
6	11	4.5		152288	W	A		FKM
6	12	2		152298	W	A	O	FKM
6	12	2		22041	W	A	OK	NBR
6	12	2		92831	W	B	O	NBR
6	12	3		64714	W	A	O	NBR
6	13	4.5		159635	W	A		FKM
6	13	4.5		81892	W	A		NBR

Any seal. Any time.

www.dichtomatik.de



油封

尺寸

d1	d2	H	H2	产品编码	产品组	设计型号	形式	材质
6	13	4.5		19765	W	B	O	NBR
6	13	5		18603	W	B		NBR
6	14	6		20731	W	A		FKM
6	14	6		38433	W	A		NBR
6	14.1	4		19683	W	A		NBR
6	15	4		18652	W	A		NBR
6	15	4		40471	W	A	O	NBR
6	15	4		73218	W	A		FKM
6	15	5.5		170030	W	A	S	FKM
6	15	6		18653	W	A		NBR
6	15	6		104172	W	A		FKM
6	16	5		18654	W	A		NBR
6	16	5		57030	W	A	S	NBR
6	16	5		104174	W	A		FKM
6	16	6		20732	W	A		FKM
6	16	6		18658	W	A		NBR
6	16	6		144364	W	A	OK	FKM
6	16	7		20459	W	A		FKM
6	16	7		72502	W	A	OK	NBR
6	16	7		18604	W	B		NBR
6	16	7		126529	W	A	S	NBR
6	16	7		38840	W	A	S	NBR
6	16	7		18655	W	A		NBR
6	17	6		19391	W	A		NBR
6	18	5		104175	W	A		FKM
6	18	5		35748	W	A		NBR
6	18	6		35749	W	A		NBR
6	18	7		35750	W	A		NBR
6	19	6		20733	W	A		FKM
6	19	6		59318	W	A		NBR
6	19	7		38841	W	A	S	NBR
6	19	7		16759	W	A		NBR
6	19	7		62615	W	A		FKM
6	20	6		41281	W	A	S	NBR
6	20	6		56735	W	A		FKM
6	21	8		39262	W	A	O	NBR
6	22	7		27673	W	A	S	NBR
6	22	7		16760	W	A		NBR
6	22	7		123847	W	A		FKM
6	22	7		20256	W	A		FKM
6	22	8		18656	W	A		NBR
6	22	8		27674	W	A	S	NBR
6	22	8		104176	W	A		FKM
6.35	12.7	3.17		134975	W	B	O	NBR
6.35	12.7	4.76		90064	W	B	O	NBR
6.35	15.87	4.76		83158	W	A		FKM
6.35	19.05	6.35		39258	W	A	O	NBR
6.35	19.05	6.35		59736	W	A	S	NBR
6.35	19.05	6.35		37270	W	A		FKM
6.35	19.05	6.35		19997	W	A		NBR
6.5	14.5	7		19596	W	A	S	NBR
6.5	19	5.5		39259	W	A	O	NBR
6.8	22	7		19597	W	A	S	NBR
7	11	2		92832	W	B	O	NBR
7	11	2		48938	W	B	O	FKM





油封

尺寸



d1	d2	H	H2	产品编码	产品组	设计型号	形式	材质
7	11	2		22042	W	A	OK	NBR
7	12.7	3		39261	W	A	O	NBR
7	14	2		22043	W	A	OK	NBR
7	14	2		48939	W	B	O	FKM
7	14	2		92833	W	B	O	NBR
7	14	4		179153	W	A	O	NBR
7	14	5		18657	W	A		NBR
7	16	6		165967	W	A		FKM
7	16	6		167595	W	A	SY	FKM
7	16	7		16761	W	A		NBR
7	16	7		35612	W	A	S	NBR
7	16	7		40102	W	B		NBR
7	16	7		20257	W	A		FKM
7	16.7	3		131111	W	A	O	NBR
7	17	7		83778	W	A	OK	NBR
7	18	7		38810	W	A		NBR
7	18	8		83458	W	A	S	NBR
7	19	6		56582	W	A		NBR
7	20	7		129964	W	A	SY	NBR
7	22	7		16762	W	A		NBR
7	22	7		20258	W	A		FKM
7	22	8		16763	W	A		NBR
7	22	8		104177	W	A		FKM
7	22	10		39260	W	A	S	NBR
7.93	12.57	2.92		60021	W	A	O	NBR
7.93	15.87	3.96		59667	W	A		NBR
7.93	17.46	7.93		37883	W	A		NBR
7.93	19.05	6.35		158019	W	A	S	FKM
7.93	19.05	6.35		19875	W	A		NBR
7.93	19.05	7.93		37268	W	A		NBR
7.93	22.22	6.35		118788	W	A	S	NBR
7.93	22.22	6.35		20795	W	A		NBR
8	11.5	3		19766	W	B	O	NBR
8	12	3		22044	W	A	OK	NBR
8	12	3		73883	W	B	O	NBR
8	12	3		48940	W	B	O	FKM
8	12	3		166055	W	B	O	NBR
8	12	3		48941	W	A	O	FKM
8	12.8	3.2		39264	W	A	O	NBR
8	13	3.5		59462	W	A	O	NBR
8	14	3		73080	W	B	O	NBR
8	14	4		38811	W	A		NBR
8	14	4		83938	W	A	OK	NBR
8	14	6		125653	W	B	O	NBR
8	14.5	6.5		19403	W	B		NBR
8	15	3		22045	W	A	OK	NBR
8	15	3		48922	W	B	O	NBR
8	15	3		44126	W	A	O	FKM
8	15	3		43924	W	A		FKM
8	15	5		38812	W	A		NBR
8	15	5		75093	W	B		NBR
8	15	7		39266	W	A		NBR
8	15	8		38813	W	A		NBR
8	16	3		123340	W	A	OK	NBR
8	16	4		159729	W	A		FKM

Any seal. Any time.

www.dichtomatik.de



油封

尺寸

d1	d2	H	H2	产品编码	产品组	设计型号	形式	材质
8	16	6		38842	W	A	S	NBR
8	16	6		18659	W	A		NBR
8	16	7		20259	W	A		FKM
8	16	7		66795	W	A	S	NBR
8	16	7		133775	W	A		FKM
8	16	7		18491	W	B		NBR
8	16	7		16764	W	A		NBR
8	16	7		168880	W	A	Y	NBR
8	18	4		131117	W	A	O	NBR
8	18	5		16765	W	A		NBR
8	18	5		27675	W	A	S	NBR
8	18	5		92752	W	A		NBR
8	18	5		179430	W	A	S	NBR
8	18	5		56736	W	A		FKM
8	18	6		104178	W	A		FKM
8	18	6		18660	W	A		NBR
8	18	6		134886	W	A	S	FKM
8	18	7		39265	W	A		NBR
8	18	7		57026	W	A	S	NBR
8	18	7		129965	W	A	SY	NBR
8	19	7		37123	W	A		FKM
8	19	7		38843	W	A	S	NBR
8	20	5		57027	W	A		NBR
8	20	5		18592	W	A	S	NBR
8	20	7		38844	W	A	S	NBR
8	20	7		130629	W	A		NBR
8	20	8		36216	W	A		NBR
8	20	8		83159	W	A		FKM
8	21	6		18593	W	A	S	NBR
8	22	6		16766	W	A		NBR
8	22	6		78301	W	A	SY	NBR
8	22	6		104179	W	A		FKM
8	22	6		19684	W	A	S	NBR
8	22	6		133578	W	A	SY	FKM
8	22	7		16767	W	A		NBR
8	22	7		130786	W	A	O	FKM
8	22	7		20260	W	A		FKM
8	22	7		18594	W	A	S	NBR
8	22	7		129966	W	A	SY	NBR
8	22	7		56737	W	A	S	FKM
8	22	8		44271	W	B		NBR
8	22	8		18595	W	A		NBR
8	22	8		104180	W	A		FKM
8	22	10		38814	W	A		NBR
8	24	7		62491	W	A		FKM
8	24	7		38643	W	B		NBR
8	24	7		16768	W	A		NBR
8	25	8		18596	W	A	S	NBR
8	26	6.5		93370	W	A	Y	NBR
8	26	6.5		127740	W	A		FKM
8	30	7		62575	W	A		FKM
8	30	7		179927	W	A	S	NBR
8	30	7		16769	W	A		NBR
8.05	22.22	6.35		59668	W	A		NBR
8.5	15	3.5		39263	W	A	O	NBR





油封

尺寸



d1	d2	H	H2	产品编码	产品组	设计型号	形式	材质
8.5	18	8		39267	W	A		NBR
9	13	3		22046	W	A	OK	NBR
9	13	3		41206	W	B	O	NBR
9	15	3		39013	W	A	O	NBR
9	16	3		22047	W	A	OK	NBR
9	16	4		19767	W	B	O	NBR
9	16	4		73093	W	A		NBR
9	16	5		34928	W	A		NBR
9	17	4.5		57039	W	B		NBR
9	18	6		16770	W	A		NBR
9	18	7		62638	W	A		FKM
9	18	7		16771	W	A		NBR
9	18	7		152053	W	A	S	FKM
9	18	8		83459	W	A	S	NBR
9	19	4		104181	W	A		FKM
9	19	4		36597	W	A		NBR
9	19	5		38815	W	A		NBR
9	19	5		27676	W	A	S	NBR
9	19	7		62967	W	A		NBR
9	20	6		118681	W	A	SY	NBR
9	20	6		157230	W	A	SY	FKM
9	20	7		57028	W	A	S	NBR
9	21	9.5		39269	W	A	S	NBR
9	22	4		39270	W	A	O	NBR
9	22	7		34811	W	B		NBR
9	22	7		38845	W	A	S	NBR
9	22	7		56738	W	A		FKM
9	22	7		18683	W	A		NBR
9	22.5	5		39268	W	A	O	NBR
9	24	7		38846	W	A	S	NBR
9	24	7		56739	W	A		FKM
9	24	7		16772	W	A		NBR
9	25	8		62632	W	A		FKM
9	26	7		62637	W	A		FKM
9	26	7		18597	W	A		NBR
9	30	7		60312	W	A		NBR
9.25	14.5	2.5		167251	W	B	O	NBR
9.5	16	4		73081	W	A	S	NBR
9.5	19	6.3		62934	W	A		NBR
9.5	25.4	8		90027	W	A		NBR
9.52	14.28	2.38		83024	W	B	O	NBR
9.52	15.87	3.17		36138	W	A	O	NBR
9.52	17.46	3.56		84281	W	A	O	NBR
9.52	19.05	6.35		158018	W	A	S	FKM
9.52	19.05	6.35		19876	W	A		NBR
9.52	22.22	6.35		19998	W	A		NBR
9.52	22.22	6.35		60026	W	B		NBR
9.52	22.22	6.35		59468	W	A	S	NBR
9.62	14.28	2.38		89320	W	B	O	NBR
9.8	20	5		26384	W	A		NBR
10	14	3		22048	W	A	OK	NBR
10	14	3		73352	W	A	OK	FKM
10	14	3		19570	W	B	O	NBR
10	15	3		21110	W	B		NBR
10	15	3		19768	W	B	O	NBR

Any seal. Any time.

www.dichtomatik.de



油封

尺寸

d1	d2	H	H2	产品编码	产品组	设计型号	形式	材质
10	15	6		57029	W	A		NBR
10	15.5	3		19769	W	B	○	NBR
10	16	3		131118	W	A	○	NBR
10	16	4		39271	W	A	○	NBR
10	16	4		34246	W	A	○	FKM
10	16	4		16773	W	A		NBR
10	16	4		159493	W	A	S	FKM
10	16	4		19770	W	B	○	NBR
10	16	4		83160	W	A		FKM
10	16	5		39014	W	A	○	NBR
10	16	5		104182	W	A		FKM
10	16	5		18598	W	A		NBR
10	16	6		77691	W	B		NBR
10	16.5	4		43576	W	A		NBR
10	17	3		48923	W	B	○	NBR
10	17	3		22049	W	A	OK	NBR
10	17	5		18599	W	B		NBR
10	17	5		179490	W	A	S	NBR
10	17	6		84522	W	A		NBR
10	18	4		130747	W	A		FKM
10	18	4		18600	W	A		NBR
10	18	4		62613	W	A		FKM
10	18	4		131002	W	A	S	NBR
10	18	5		104184	W	A		FKM
10	18	5		18601	W	A		NBR
10	18	6		16774	W	A		NBR
10	18	6		39253	W	A	S	NBR
10	18	6		62614	W	A	S	FKM
10	18	6		38029	W	A		NBR
10	18	6		104183	W	A		FKM
10	18	6		19742	W	B		NBR
10	18	9		104185	W	A		FKM
10	18	9		26385	W	A		NBR
10	19	4		174946	W	A		FKM
10	19	4		39280	W	A		NBR
10	19	6		62616	W	A		FKM
10	19	6.5		18605	W	A		NBR
10	19	7		135245	W	A	S	FKM
10	19	7		129714	W	A	S	NBR
10	19	7		16776	W	A		NBR
10	19	7		38847	W	A	S	NBR
10	19	7		16775	W	B		NBR
10	19	7		20261	W	A		FKM
10	19	8		39272	W	A		NBR
10	20	2.7		150695	W	A	OK	NBR
10	20	4		28395	W	A		NBR
10	20	5		18606	W	A	S	NBR
10	20	5		39273	W	A		NBR
10	20	5		130627	W	B		NBR
10	20	6		157286	W	A	SY	NBR
10	20	6		16777	W	A		NBR
10	20	6		48598	W	A	SY	FKM
10	20	6		39178	W	A	S	NBR
10	20	7		18607	W	A	S	NBR
10	20	7		27032	W	A		NBR





油封

尺寸



d1	d2	H	H2	产品编码	产品组	设计型号	形式	材质
10	20	7		78781	W	A	Y	NBR
10	21	4		77303	W	A	OK	NBR
10	21	5		18608	W	A		NBR
10	22	3		48924	W	A	OK	NBR
10	22	4		38848	W	A	S	NBR
10	22	5		18609	W	A	S	NBR
10	22	6		16778	W	A		NBR
10	22	6		118682	W	A	SY	NBR
10	22	6		133579	W	A	SY	FKM
10	22	6		38849	W	A	S	NBR
10	22	6		56019	W	A		FKM
10	22	6		62366	W	A	SY	FKM
10	22	7		16779	W	A		NBR
10	22	7		20262	W	A		FKM
10	22	7		118046	W	A		FKM
10	22	7		37145	W	A	S	NBR
10	22	8		40361	W	C		NBR
10	22	8		16780	W	A		NBR
10	22	8		44272	W	B		NBR
10	22	8		62619	W	A		FKM
10	24	7		40103	W	B		NBR
10	24	7		56740	W	A		FKM
10	24	7		16781	W	A		NBR
10	24	7		39188	W	A	S	NBR
10	24	10		39275	W	A		NBR
10	25	4.5		39274	W	A	S	NBR
10	25	6		39276	W	A		NBR
10	25	6		104186	W	A		FKM
10	25	7		129967	W	A	SY	NBR
10	25	7		18610	W	A	S	NBR
10	25	7		166557	W	B		NBR
10	25	8		37432	W	A		NBR
10	26	5		39277	W	A	O	NBR
10	26	7		62492	W	A		FKM
10	26	7		159714	W	A		FKM
10	26	7		28953	W	A	Y	FKM
10	26	7		16782	W	A		NBR
10	26	7		80699	W	A	S	NBR
10	26	7		38850	W	A	S	NBR
10	26	7		18665	W	B		NBR
10	28	7		16783	W	A		NBR
10	28	7		70293	W	A	S	NBR
10	28	7		56741	W	A		FKM
10	28	8		20460	W	A		FKM
10	30	6		39278	W	A	O	NBR
10	30	7		16784	W	A		NBR
10	30	7		74867	W	B		NBR
10	30	7		20466	W	A		FKM
10	30	8		46293	W	B		NBR
10	30	8		38816	W	A		NBR
10	30	8		60311	W	A		FKM
10	30	10		18611	W	B		NBR
10	30	10		39279	W	A		NBR
10.71	20.14	4.76		41204	W	B		NBR
11	17	3		131126	W	B	O	NBR



















Any seal. Any time.

www.dichtomatik.de



油封

尺寸

d1	d2	H	H2	产品编码	产品组	设计型号	形式	材质	
11	17	4		73085	W	B		NBR	
11	17	4		35204	W	A		FKM	
11	17	4		57031	W	A	S	NBR	
11	17	4		18612	W	A		NBR	
11	18	4		130833	W	A		NBR	
11	18	15		41207	W	B	O	NBR	
11	21	8		18613	W	A	S	NBR	
11	21.5	5		39281	W	A		NBR	
11	22	7		20263	W	A		FKM	
11	22	7		18614	W	A	S	NBR	
11	22	7		157231	W	A	SY	FKM	
11	22	7		132607	W	A	SY	NBR	
11	22	7		16785	W	A		NBR	
11	22	8		104187	W	A		FKM	
11	22	8		18569	W	A		NBR	
11	23	8		39282	W	A		NBR	
11	26	6		16786	W	A		NBR	
11	26	6		62560	W	A		FKM	
11	26	7		18684	W	A		NBR	
11	26	7		62493	W	A		FKM	
11	26	7		62494	W	A	S	FKM	
11	30	5		38851	W	A	S	NBR	
11	30	7		26216	W	A	S	NBR	
11	30	7		104188	W	A		FKM	
11	30	7		26251	W	A		NBR	
11	30	8		39283	W	A		NBR	
11	30	10		81900	W	A		NBR	
11.02	25.4	6.35		59737	W	A	S	NBR	
11.07	23.01	6.3		60617	W	B	S	NBR	
11.11	19.05	3.17		60741	W	B	O	NBR	
11.11	20.98	4.76		60742	W	B	O	NBR	
11.11	22.22	3.96		125670	W	B	O	NBR	
11.11	22.22	6.35		19999	W	A		NBR	
11.11	22.22	6.35		35313	W	A	S	NBR	
11.11	23.06	6.35		60618	W	B	S	NBR	
11.11	25.4	6.35		19991	W	A		NBR	
11.11	25.4	7.93		59669	W	A		NBR	
11.11	28.57	9.52		20000	W	A		NBR	
11.6	24	10		19772	W	A	S	NBR	
12	15.5	3		178006	W	B	O	NBR	
12	16	3		48942	W	A	O	FKM	
12	16	3		90202	W	B	O	FKM	
12	16	3		22050	W	A	OK	NBR	
12	16	3		77946	W	B	O	NBR	
12	18	3		22051	W	A	OK	NBR	
12	18	3		48943	W	A	O	FKM	
12	18	3		19771	W	B	O	NBR	
12	18	4		18570	W	B		NBR	
12	18	4		38480	W	A	O	NBR	
12	18	4.5		18571	W	A		NBR	
12	18	4.5		57032	W	A	S	NBR	
12	18	4.5		39284	W	A	O	NBR	
12	18	4.5		70446	W	B	S	NBR	
12	18	4.5		104189	W	A		FKM	
12	18	5		38817	W	A		NBR	



油封

尺寸



d1	d2	H	H2	产品编码	产品组	设计型号	形式	材质
12	18	5		104190	W	A		FKM
12	18	5		57033	W	A	S	NBR
12	18	5		41209	W	B	O	NBR
12	18	5		131107	W	A	O	NBR
12	18	5.5		77246	W	A	O	NBR
12	19	2.5		41208	W	B	O	NBR
12	19	3		22052	W	A	OK	NBR
12	19	3		48925	W	B	O	NBR
12	19	4		36471	W	A		NBR
12	19	5		41348	W	B		NBR
12	19	5		16787	W	A		NBR
12	19	5		62617	W	A		FKM
12	19	5		57034	W	A	S	NBR
12	19	5		175688	W	A	S	NBR
12	20	4		38852	W	A	S	NBR
12	20	4		19773	W	B	O	NBR
12	20	4		69015	W	A	O	NBR
12	20	4		36470	W	A		NBR
12	20	5		16788	W	A		NBR
12	20	5		130794	W	A	O	NBR
12	20	5		39285	W	A	O	NBR
12	20	5		122334	W	A	S	NBR
12	20	5		48599	W	A		FKM
12	20	5		18572	W	B		NBR
12	20	5		85234	W	B	S	NBR
12	20	7		57035	W	A		NBR
12	21	4		18573	W	A		NBR
12	21	4		104192	W	A		FKM
12	21	4		179530	W	A	S	NBR
12	21	5		18574	W	A		NBR
12	21	5		41205	W	B	S	NBR
12	22	4		39286	W	A	OK	NBR
12	22	4		18575	W	A		NBR
12	22	4		18576	W	B		NBR
12	22	4		120938	W	A		FKM
12	22	4		117593	W	A		FKM
12	22	4		36811	W	A		NBR
12	22	4		56742	W	A		FKM
12	22	4.5		20734	W	A		FKM
12	22	4.5		35427	W	A		NBR
12	22	5		18577	W	A		NBR
12	22	5		130950	W	A	S	NBR
12	22	5		180167	W	A		FKM
12	22	5		57036	W	A	S	NBR
12	22	5.5		81240	W	A	SY	NBR
12	22	6		77834	W	A	SY	NBR
12	22	6		16790	W	A	S	NBR
8	22	6		81227	W	A	SY	FKM
12	22	6		16789	W	A		NBR
12	22	6		41210	W	B	O	NBR
12	22	6		160721	W	A	SY	NBR
12	22	6		132608	W	A	SY	NBR
12	22	6		131168	W	A	SY	FKM
12	22	6		62620	W	A		FKM
12	22	6.5		18578	W	A		NBR

Any seal. Any time.

www.dichtomatik.de



油封

尺寸

d1	d2	H	H2	产品编码	产品组	设计型号	形式	材质
12	22	6.5		37434	W	A	S	NBR
12	22	7		20264	W	A		FKM
12	22	7		56743	W	A	S	FKM
12	22	7		16791	W	A		NBR
12	22	7		16792	W	B		NBR
12	22	7		18579	W	A	S	NBR
12	22	7		131157	W	A	SY	NBR
12	22	7		27695	W	A		NBR
12	22	7		130773	W	A		FKM
12	22	7.5		16793	W	A	S	NBR
12	22	8		39287	W	A	S	NBR
12	22	8		62621	W	A		FKM
12	22	8		16794	W	A		NBR
12	22	9		18580	W	A	S	NBR
12	22	10		134951	W	B		NBR
12	23	8		18581	W	A	S	NBR
12	24	4		131106	W	A	O	NBR
12	24	4.5		130866	W	A		FKM
12	24	4.5		57037	W	A		NBR
12	24	4.5		78531	W	A		NBR
12	24	6		62624	W	A		FKM
12	24	6		16795	W	A		NBR
12	24	6		18582	W	A	S	NBR
12	24	6		133556	W	A	SY	FKM
12	24	6.5		83161	W	A		FKM
12	24	6.5		18583	W	A		NBR
12	24	7		16796	W	A		NBR
12	24	7		62612	W	A	S	FKM
12	24	7		34929	W	A		FKM
12	24	7		157232	W	A	SY	FKM
12	24	7		16797	W	A	S	NBR
12	24	7		157287	W	A	SY	NBR
12	24	7		18584	W	B		NBR
12	24	7.5		38818	W	A		NBR
12	24	8		74715	W	A	S	NBR
12	24	8		16798	W	A		NBR
12	24	8		62625	W	A		FKM
12	24	10		44237	W	A		NBR
12	24.5	5.5		16757	W	A		NBR
12	25	3		20658	W	B	O	NBR
12	25	4.5		18585	W	A		NBR
12	25	4.5		18586	W	A	S	NBR
12	25	5		18587	W	A		NBR
12	25	5		55894	W	A		FKM
12	25	5		18588	W	B		NBR
12	25	5		56177	W	A	S	NBR
12	25	6		39288	W	A		NBR
12	25	7		18589	W	A	S	NBR
12	25	7		68241	W	A		FKM
12	25	7		37095	W	A		NBR
12	25	7		129968	W	A	SY	NBR
12	25	8		38853	W	A	S	NBR
12	25	8		16799	W	A		NBR
12	25	8		62633	W	A		FKM
12	25	8		18590	W	B		NBR





油封

尺寸



d1	d2	H	H2	产品编码	产品组	设计型号	形式	材质
12	26	6		79069	W	A		NBR
12	26	6.5		19484	W	A		NBR
12	26	7		81899	W	A		FKM
12	26	7		62561	W	A		FKM
12	26	7		38854	W	A	S	NBR
12	26	7		16800	W	A		NBR
12	26	8		62562	W	A		FKM
12	26	8		16801	W	A		NBR
12	26	8		38855	W	A	S	NBR
12	28	4		161875	W	A	O	FKM
12	28	5		38819	W	A		NBR
12	28	7		41383	W	B	S	NBR
12	28	7		16803	W	B		NBR
12	28	7		22551	W	A		FKM
12	28	7		38856	W	A	S	NBR
12	28	7		76242	W	A	S	FKM
12	28	7		16802	W	A		NBR
12	28	7		107740	W	A	SY	NBR
12	28	8		104193	W	A		FKM
12	28	8		38824	W	A		NBR
12	28	8		18591	W	A	S	NBR
12	30	5		16804	W	B		NBR
12	30	5		19774	W	B	O	NBR
12	30	5		75964	W	A		NBR
12	30	6		18546	W	A		NBR
12	30	7		18549	W	B		NBR
12	30	7		174497	W	A	S	FKM
12	30	7		38680	W	B	S	NBR
12	30	7		18548	W	A	S	NBR
12	30	7		22552	W	A		FKM
12	30	7		18547	W	A		NBR
12	30	7		130757	W	A		FKM
12	30	7		159715	W	A		FKM
12	30	9		18550	W	A	S	NBR
12	30	10		62576	W	A		FKM
12	30	10		16805	W	A		NBR
12	32	5		38301	W	A		NBR
12	32	5		104194	W	A		FKM
12	32	7		19685	W	B	S	NBR
12	32	7		18666	W	B		NBR
12	32	7		107741	W	A	SY	NBR
12	32	7		62489	W	A		FKM
12	32	7		18551	W	A	S	NBR
12	32	7		16806	W	A		NBR
12	32	7		162916	W	A	S	FKM
12	32	10		18552	W	A		NBR
12	34	7		39290	W	A	S	NBR
12	35	4.3		64559	W	A		NBR
12	35	4.5		39292	W	A	O	NBR
12	35	4.5		41211	W	B	O	NBR
12	35	7		115494	W	A		FKM
12	35	7		43605	W	A		NBR
12	35	10		18553	W	A		NBR
12	35	14		39291	W	A	O	NBR
12	37	7		19585	W	A	O	NBR



















Any seal. Any time.

www.dichtomatik.de



油封

尺寸

d1	d2	H	H2	产品编码	产品组	设计型号	形式	材质	
12	37	7		61724	W	B		NBR	
12	37	10		38825	W	A		NBR	
12	37	10		60310	W	B		NBR	
12	42	8		18554	W	A	S	NBR	
12	45	7		82987	W	A		NBR	
12	50	5		104317	W	A		FKM	
12	52	7		44234	W	A		NBR	
12.3	32	5		39289	W	A		NBR	
12.45	26.97	6.35		83439	W	A		NBR	
12.5	19	5		83437	W	A		NBR	
12.5	20	5		76323	W	A		NBR	
12.5	20	6		83438	W	A		NBR	
12.5	20.5	5		39293	W	A		NBR	
12.5	22	5		38826	W	A		NBR	
12.5	22.3	6.5		41212	W	B	O	NBR	
12.5	23.5	10		57038	W	A	S	NBR	
12.5	25	8		131026	W	A	S	NBR	
12.7	17.46	2.4		144105	W	A	O	NBR	
12.7	17.46	3.17		60743	W	B	O	NBR	
12.7	19	3		39294	W	A	O	NBR	
12.7	19.05	4.76		60619	W	B	S	NBR	
12.7	22.22	3.17		60826	W	B	O	NBR	
12.7	22.22	3.17		60022	W	A	O	NBR	
12.7	22.22	6.35		104318	W	A		FKM	
12.7	22.22	6.35		19877	W	A		NBR	
12.7	22.22	6.35		150376	W	A	SY	NBR	
12.7	22.22	6.35		48600	W	A	S	FKM	
12.7	22.22	6.35		83460	W	A	S	NBR	
12.7	25.06	6.35		60027	W	B		NBR	
12.7	25.4	4.76		56744	W	A		FKM	
12.7	25.4	4.76		20652	W	A		NBR	
12.7	25.4	6.35		20001	W	A		NBR	
12.7	25.4	6.35		60620	W	B	S	NBR	
12.7	25.4	6.35		59738	W	A	S	NBR	
12.7	25.4	6.35		41496	W	B		NBR	
12.7	25.4	6.35		37714	W	A		FKM	
12.7	25.4	7.93		20796	W	A	S	NBR	
12.7	25.4	7.93		22235	W	B		NBR	
12.7	25.4	9.52		19879	W	A		NBR	
12.7	25.4	9.52		36775	W	C	S	NBR	
12.7	26	6		56979	W	A		NBR	
12.7	28.57	6.35		19881	W	A		NBR	
12.7	28.57	6.35		59739	W	A	S	NBR	
12.7	28.57	6.35		60621	W	B	S	NBR	
12.7	28.57	7.93		19882	W	A		NBR	
12.7	28.57	9.52		20002	W	A		NBR	
12.7	31.75	6.35		20003	W	A		NBR	
12.7	31.75	9.52		56745	W	A		FKM	
12.7	31.75	9.52		37930	W	A		NBR	
12.8	28.8	6.5		41349	W	B		NBR	
13	18	3		39321	W	A	OK	NBR	
13	18	3		41213	W	B	O	NBR	
13	19	3		22053	W	A	OK	NBR	
13	19	3		41214	W	B	O	NBR	
13	19	3		69633	W	A		NBR	



油封

尺寸



d1	d2	H	H2	产品编码	产品组	设计型号	形式	材质
13	19	5		41215	W	B	○	NBR
13	22	4		62622	W	A		FKM
13	22	4		74863	W	A		NBR
13	22	5		16807	W	A		NBR
13	22	5		104195	W	A		FKM
13	22	5		19572	W	A	○	NBR
13	22	5		36812	W	B	S	NBR
13	22	5		18555	W	B		NBR
13	22	6		18556	W	A		NBR
13	22.2	7		41351	W	B		NBR
13	23	6.5		41350	W	B		NBR
13	24	7		60309	W	A		NBR
13	25	4		38827	W	A		NBR
13	25	5		38828	W	A		NBR
13	25	5		39295	W	A	S	NBR
13	25	7		57040	W	B		NBR
13	25	7		57041	W	B	○	NBR
13	25	7		104196	W	A		FKM
13	25	7		18557	W	A	S	NBR
13	25	7		16808	W	A		NBR
13	26	4		39296	W	A	○	NBR
13	26	5		18558	W	A		NBR
13	26	7		18559	W	A	S	NBR
13	26	7		163506	W	A		NBR
13	26	7		16809	W	A		NBR
13	26	7		69946	W	A		FKM
13	26	9		44273	W	B		NBR
13	26	9		38857	W	A	S	NBR
13	26	9		44219	W	A		NBR
13	27.2	6.3		57042	W	B		NBR
13	28	7		16810	W	A	S	NBR
13	28	7		129969	W	A	SY	NBR
13	28	7		35009	W	A		NBR
13	28	7		175568	W	A	S	NBR
13	30	5		39297	W	A		NBR
13	30	7		18560	W	A		NBR
13	30	7		171295	W	A	SY	NBR
13	30	7		56746	W	A		FKM
13	30	8		16811	W	A		NBR
13	30	8		62577	W	A		FKM
13	30	10		16812	W	A		NBR
13	30	10		18561	W	A	S	NBR
13	32	6		38829	W	A		NBR
13	32	7		18562	W	A		NBR
13	35	10		22354	W	A		NBR
13.5	26	8		19598	W	A	S	NBR
13.5	32	5		39322	W	A		NBR
13.7	22	5		38830	W	A		NBR
13.7	24	5		19599	W	A		NBR
13.8	26	7		39298	W	A		NBR
14	18	3		131128	W	B	○	NBR
14	18	3		36642	W	A	○	NBR
14	20	3		22054	W	A	OK	NBR
14	20	3		161296	W	B	○	NBR
14	20	5		19571	W	A	OK	NBR



















Any seal. Any time.

www.dichtomatik.de



油封

尺寸

d1	d2	H	H2	产品编码	产品组	设计型号	形式	材质	
14	20	5		89767	W	A		NBR	
14	20	5		120517	W	A		FKM	
14	20	5		18563	W	B		NBR	
14	21	3		22055	W	A	OK	NBR	
14	21	4		38831	W	A		NBR	
14	22	3		22056	W	A	OK	NBR	
14	22	3		110708	W	B	O	NBR	
14	22	4		38858	W	A	S	NBR	
14	22	4		179188	W	A	S	FKM	
14	22	4		62623	W	A		FKM	
14	22	4		19573	W	A	OK	NBR	
14	22	4		16813	W	A		NBR	
14	22	4.5		75421	W	A	S	NBR	
14	22	5		18565	W	B		NBR	
14	22	5		83461	W	A	S	NBR	
14	22	5		18564	W	A		NBR	
14	22	6		41216	W	B	O	NBR	
14	22	7		104197	W	A		FKM	
14	22	7		61095	W	A	S	NBR	
14	22	7		18566	W	A		NBR	
14	23	6		18567	W	A		NBR	
14	24	4		57043	W	B	O	NBR	
14	24	4		39323	W	A	S	NBR	
14	24	5		18523	W	B		NBR	
14	24	5		18527	W	A		NBR	
14	24	5		43679	W	A	S	NBR	
14	24	5		39015	W	A	O	NBR	
14	24	5		88549	W	A	S	FKM	
14	24	6		62626	W	A		FKM	
14	24	6		44992	W	B		NBR	
14	24	6		18524	W	A		NBR	
14	24	7		124954	W	A	Y	NBR	
14	24	7		157233	W	A	SY	FKM	
14	24	7		157288	W	A	SY	NBR	
14	24	7		16814	W	A		NBR	
14	24	7		20265	W	A		FKM	
14	24	7		74435	W	B	S	NBR	
14	24	7		38466	W	A	S	NBR	
14	24	7		18525	W	B		NBR	
14	24	8		39324	W	A		NBR	
14	24	8		18526	W	A	S	NBR	
14	24.5	6		39325	W	A	O	NBR	
14	25	4		159730	W	A		FKM	
14	25	4		159731	W	A		NBR	
14	25	5		35044	W	A		NBR	
14	25	6		38832	W	A		NBR	
14	25	7		16815	W	A		NBR	
14	25	7		62634	W	A		FKM	
14	25	7		36581	W	A	S	NBR	
14	25	8		75840	W	A		NBR	
14	26	6		39326	W	A	S	NBR	
14	26	7		18529	W	A		NBR	
14	26	7		36820	W	A	S	NBR	
14	26	7		18530	W	B		NBR	
14	26	7		104198	W	A		FKM	



油封

尺寸



d1	d2	H	H2	产品编码	产品组	设计型号	形式	材质
14	27	3		39327	W	A	OK	NBR
14	27	7		20735	W	A		FKM
14	27	7		39328	W	A	S	NBR
14	28	6		60308	W	A		NBR
14	28	7		18532	W	B		NBR
14	28	7		16816	W	A		NBR
14	28	7		129970	W	A	SY	NBR
14	28	7		62566	W	A		FKM
14	28	7		62495	W	A	S	FKM
14	28	7		148473	W	A		FKM
14	28	7		18531	W	A	S	NBR
14	28	8		18533	W	A	S	NBR
14	28	10		83162	W	A		FKM
14	28.5	10		39329	W	A		NBR
14	30	4.5		157864	W	B		NBR
14	30	7		38859	W	A	S	NBR
14	30	7		16817	W	A		NBR
14	30	7		20266	W	A		FKM
14	30	8		16818	W	A		NBR
14	30	8		44274	W	B		NBR
14	30	8		18534	W	A	S	NBR
14	30	8		104199	W	A		FKM
14	30	10		38860	W	A	S	NBR
14	30	10		18535	W	A		NBR
14	30	13		38861	W	A	S	NBR
14	32	5		18536	W	A		NBR
14	32	7		18667	W	B		NBR
14	32	7		38862	W	A	S	NBR
14	32	7		104200	W	A		FKM
14	32	7		38833	W	A		NBR
14	32	7		131088	W	A	S	NBR
14	32	10		38834	W	A		NBR
14	34	7		38835	W	A		NBR
14	35	4.5		16819	W	A		NBR
14	35	7		16820	W	A		NBR
14	35	7		38634	W	A	S	NBR
14	35	7		62596	W	A		FKM
14	35	8		16821	W	A		NBR
14	35	8		62597	W	A		FKM
14	35	10		16822	W	B		NBR
14	36	7		38863	W	A	S	NBR
14.28	19.05	2.92		60023	W	A	O	NBR
14.28	20.64	4		78375	W	B	O	NBR
14.28	25.4	6.35		60827	W	C		NBR
14.28	25.4	6.35		20004	W	A		NBR
14.28	25.4	6.35		59740	W	A	S	NBR
14.28	25.4	6.35		60028	W	B		NBR
14.28	26.98	4.76		60029	W	B		NBR
14.28	26.98	6.35		60030	W	B		NBR
14.28	28.57	6.35		59741	W	A	S	NBR
14.28	28.57	6.35		90947	W	B		FKM
14.28	28.57	6.35		20005	W	A		NBR
14.28	28.57	9.52		19883	W	A		NBR
14.28	34.92	7.93		20242	W	A		NBR
14.28	35.03	10.31		61038	W	C	S	NBR

Any seal. Any time.

www.dichtomatik.de



油封

尺寸

d1	d2	H	H2	产品编码	产品组	设计型号	形式	材质
14.5	30	8		19600	W	A	S	NBR
14.7	30	7		38865	W	A	S	NBR
14.8	30	5		38866	W	A		NBR
14.8	30	5		57044	W	B		NBR
14.8	30	7		38867	W	A		NBR
15	21	2		48928	W	B	O	NBR
15	21	3		48926	W	B	O	NBR
15	21	3		22057	W	A	OK	NBR
15	21	4		16823	W	A		NBR
15	21	4		44142	W	A	OK	NBR
15	21	4		62618	W	A		FKM
15	21	4.4		38868	W	A		NBR
15	21	4.4		130882	W	B	S	NBR
15	21	4.5		18537	W	B	S	NBR
15	21	5		39330	W	A	O	NBR
15	21	5		43690	W	A		NBR
15	22	3		39332	W	A	O	NBR
15	22	3		41217	W	B	O	NBR
15	22	4		39333	W	A	OK	NBR
15	22	5		38869	W	A	S	NBR
15	22	7		104201	W	A		FKM
15	22	7		16824	W	A		NBR
15	23	2.5		39334	W	A	O	NBR
15	23	3		22058	W	A	OK	NBR
15	23	3		41218	W	B	O	NBR
15	23	3		121268	W	A	OK	FKM
15	23	3.8		131124	W	B	O	NBR
15	23	5		39335	W	A	O	NBR
15	24	4		130767	W	A		FKM
15	24	5		16825	W	A		NBR
15	24	5		157189	W	A	O	NBR
15	24	5		62627	W	A		FKM
15	24	7		16827	W	B		NBR
15	24	7		18538	W	A	S	NBR
15	24	7		36647	W	B	S	NBR
15	24	7		107742	W	A	SY	NBR
15	24	7		22497	W	A	S	FKM
15	24	7		157234	W	A	SY	FKM
15	24	7		16826	W	A		NBR
15	24	7		20267	W	A		FKM
15	24	7		40472	W	A	O	NBR
15	24	9		39336	W	A		NBR
15	24.5	5		57045	W	B	O	NBR
15	25	3		77606	W	A	OK	NBR
15	25	3.8		131127	W	B	O	NBR
15	25	5		16828	W	B		NBR
15	25	5		18688	W	A		NBR
15	25	5		44932	W	A		FKM
15	25	5		44981	W	A	S	NBR
15	25	6		104202	W	A		FKM
15	25	6		178909	W	A	SY	NBR
15	25	6		150472	W	A	SY	FKM
15	25	6		18540	W	A		NBR
15	25	6		18541	W	A	S	NBR
15	25	6		163366	W	A	S	FKM





油封

尺寸



d1	d2	H	H2	产品编码	产品组	设计型号	形式	材质
15	25	6		118683	W	A	SY	NBR
15	25	7		18542	W	A	S	NBR
15	25	7		41352	W	B		NBR
15	25	7		69749	W	A		NBR
15	25	7		157235	W	A	SY	FKM
15	25	7		157289	W	A	SY	NBR
15	25	10		41353	W	B		NBR
15	25.4	8		39340	W	A	S	NBR
15	25.5	5		39337	W	A		NBR
15	25.5	7		18543	W	A		NBR
15	26	4		177106	W	B	S	FKM
15	26	4.5		104203	W	A		FKM
15	26	4.5		117978	W	B	O	NBR
15	26	4.5		16829	W	A		NBR
15	26	6		18544	W	A		NBR
15	26	6		18545	W	A	S	NBR
15	26	7		16830	W	A		NBR
15	26	7		16831	W	A	S	NBR
15	26	7		39354	W	A	S	NBR
15	26	7		38305	W	A		FKM
15	26	7		37873	W	B	S	NBR
15	26	7		18500	W	B		NBR
15	26	7		62582	W	A	S	FKM
15	26	7		131112	W	A	O	NBR
15	26.5	4.6		38304	W	A		NBR
15	26.5	4.6		38306	W	A		FKM
15	27	7		18502	W	A	S	NBR
15	27	7		62563	W	A		FKM
15	27	7		18501	W	A		NBR
15	28	3		57046	W	B	O	NBR
15	28	4		37433	W	A		NBR
15	28	5		48601	W	A		FKM
15	28	6		62567	W	A		FKM
15	28	6		130821	W	A		NBR
15	28	6		38870	W	A	S	NBR
15	28	7		38871	W	A	S	NBR
15	28	7		56747	W	A		FKM
15	28	7		16832	W	A		NBR
15	28	7		18668	W	B		NBR
15	28	7		134230	W	A	S	FKM
15	28	8		44235	W	A		NBR
15	28	10		39338	W	A		NBR
15	30	4.5		38434	W	A		NBR
15	30	4.5		56748	W	A		FKM
15	30	4.5		130854	W	A		FKM
15	30	5		18505	W	A	S	NBR
15	30	5		104204	W	A		FKM
15	30	5		18504	W	A		NBR
15	30	5.5		18506	W	A		NBR
15	30	5.5		104205	W	A		FKM
15	30	6		84881	W	A		FKM
15	30	6		62966	W	A		NBR
15	30	7		130842	W	A		FKM
15	30	7		16833	W	A		NBR
15	30	7		62584	W	A	S	FKM

Any seal. Any time.

www.dichtomatik.de



油封

尺寸

d1	d2	H	H2	产品编码	产品组	设计型号	形式	材质
15	30	7		149911	W	A	SY	FKM
15	30	7		16834	W	A	S	NBR
15	30	7		20268	W	A		FKM
15	30	7		178904	W	B	S	FKM
15	30	7		116484	W	A	SY	NBR
15	30	7		16835	W	B		NBR
15	30	7		16836	W	B	S	NBR
15	30	8		18507	W	B		NBR
15	30	8		38872	W	A	S	NBR
15	30	8		16837	W	A		NBR
15	30	8		62578	W	A		FKM
15	30	10		19686	W	C	S	NBR
15	30	10		38739	W	C		NBR
15	30	10		16839	W	B		NBR
15	30	10		38873	W	A	S	NBR
15	30	10		16838	W	A		NBR
15	30	10		20269	W	A		FKM
15	30	12		18508	W	A	S	NBR
15	32	5		38875	W	A		NBR
15	32	5		38874	W	A	S	NBR
15	32	5.5		19582	W	B	O	NBR
15	32	5.5		104206	W	A		FKM
15	32	5.5		18503	W	A		NBR
15	32	7		20270	W	A		FKM
15	32	7		16841	W	A	S	NBR
15	32	7		161759	W	A	S	FKM
15	32	7		130843	W	A		FKM
15	32	7		18669	W	B		NBR
15	32	7		16840	W	A		NBR
15	32	7		118684	W	A	SY	NBR
15	32	8		16842	W	A		NBR
15	32	8		38876	W	A	S	NBR
15	32	9		18509	W	A	S	NBR
15	32	9		38877	W	A		NBR
15	32	10		60306	W	A		NBR
15	33	7		18510	W	A		NBR
15	33	7		104207	W	A		FKM
15	33	10		45323	W	A	S	NBR
15	35	5		16843	W	A		NBR
15	35	5		62599	W	A		FKM
15	35	6		118685	W	A	SY	NBR
15	35	6		133557	W	A	SY	FKM
15	35	6		56930	W	A	S	NBR
15	35	7		18671	W	B		NBR
15	35	7		22553	W	A		FKM
15	35	7		133464	W	A	O	NBR
15	35	7		18512	W	A	S	NBR
15	35	7		18689	W	A		NBR
15	35	7		82246	W	A	S	FKM
15	35	7		18494	W	B	S	NBR
15	35	7		130992	W	A	S	FKM
15	35	7		130812	W	A		FKM
15	35	7		134474	W	A	SY	FKM
15	35	8		16845	W	A		NBR
15	35	8		18513	W	A	S	NBR





油封

尺寸



d1	d2	H	H2	产品编码	产品组	设计型号	形式	材质
15	35	8		62600	W	A		FKM
15	35	8		56945	W	A	S	NBR
15	35	10		18670	W	B		NBR
15	35	10		38878	W	A	S	NBR
15	35	10		16846	W	A		NBR
15	35	10		62601	W	A		FKM
15	35.2	5.5		38879	W	A	S	NBR
15	36	7		39339	W	A	S	NBR
15	37	6		38880	W	A	S	NBR
15	37	7		38881	W	A	S	NBR
15	37	7		38882	W	A		NBR
15	37	7		20736	W	A		FKM
15	37	10		18514	W	A		NBR
15	40	8		38883	W	A	S	NBR
15	40	10		73049	W	B		NBR
15	40	10		38884	W	A	S	NBR
15	40	10		16847	W	A		NBR
15	40	10		165339	W	A	S	FKM
15	40	10		62664	W	A		FKM
15	42	7		16848	W	A		NBR
15	42	7		56749	W	A		FKM
15	42	7		38885	W	A	S	NBR
15	42	8		18515	W	A	S	NBR
15	42	10		7697	W	C		NBR
15	42	10		118981	W	C		FKM
15	42	10		16849	W	A		NBR
15	42	10		18516	W	A	S	NBR
15	42	10		148476	W	A		FKM
15	42	10		20271	W	A		FKM
15	48	8		18517	W	A	S	NBR
15.08	31.75	6.35		59742	W	A	S	NBR
15.3	22	7		19601	W	A		NBR
15.5	22	3		39331	W	A	O	NBR
15.6	25	7		18492	W	A		NBR
15.6	25	7		62635	W	A		FKM
15.6	30	7		19602	W	A	S	NBR
15.7	25.5	4.6		62636	W	A		FKM
15.87	23.81	4.76		19878	W	A		NBR
15.87	23.81	4.76		59743	W	A	S	NBR
15.87	23.81	4.76		60031	W	B		NBR
15.87	23.81	4.76		60744	W	B	O	NBR
15.87	25.4	4.76		27465	W	A		FKM
15.87	25.4	4.76		59744	W	A	S	NBR
15.87	25.4	4.76		20006	W	A		NBR
15.87	25.4	4.76		60032	W	B		NBR
15.87	25.4	6.35		60622	W	B	S	NBR
15.87	25.4	6.35		60828	W	C		NBR
15.87	25.4	6.35		19880	W	A		NBR
15.87	25.4	6.35		40238	W	B		NBR
15.87	28.55	4		57047	W	A		NBR
15.87	28.57	4.76		56892	W	B		NBR
15.87	28.57	6.35		49505	W	A		FKM
15.87	28.57	6.35		19884	W	A		NBR
15.87	28.57	6.35		80476	W	C		NBR
15.87	28.57	6.35		59745	W	A	S	NBR

Any seal. Any time.

www.dichtomatik.de



油封

尺寸

d1	d2	H	H2	产品编码	产品组	设计型号	形式	材质
15.87	28.57	6.35		60033	W	B		NBR
15.87	28.57	7.93		20007	W	A		NBR
15.87	28.57	7.93		60829	W	C		NBR
15.87	28.57	9.52		20008	W	A		NBR
15.87	28.57	9.52		27404	W	C		NBR
15.87	28.57	9.52		46823	W	B		NBR
15.87	31.75	6.35		59746	W	A	S	NBR
15.87	31.75	6.35		60034	W	B		NBR
15.87	31.75	6.35		20009	W	A		NBR
15.87	31.75	7.93		19887	W	A		NBR
15.87	31.75	9.52		19888	W	A		NBR
15.87	33.33	6.35		60035	W	B		NBR
15.87	33.33	6.35		19891	W	A		NBR
15.87	34.92	6.35		59747	W	A	S	NBR
15.87	34.92	6.35		20011	W	A		NBR
15.87	34.92	7.93		39729	W	B		NBR
15.87	34.92	7.93		19892	W	A		NBR
15.87	34.92	7.93		60891	W	C	S	NBR
15.87	34.92	9.52		20012	W	A		NBR
15.87	34.92	9.52		60036	W	B		NBR
15.87	38.1	6.35		20239	W	A		NBR
15.87	38.1	9.52		19900	W	A		NBR
15.87	40.08	6.35		59670	W	A		NBR
16	20	2.5		44211	W	B	O	NBR
16	21	3		41220	W	B	O	NBR
16	22	3		48944	W	A	O	FKM
16	22	3		22059	W	A	OK	NBR
16	22	3		41219	W	B	O	NBR
16	22	3		116305	W	B	O	NBR
16	22	4		56790	W	A	S	NBR
16	22	4		18518	W	B		NBR
16	22	4		38435	W	A		NBR
16	22	4		19574	W	A	O	NBR
16	22	4		167193	W	A	O	FKM
16	22	7		64656	W	A		NBR
16	22	7		88176	W	A	S	NBR
16	22.2	4		43694	W	A		NBR
16	22.2	4		48603	W	A		FKM
16	23	4		39341	W	A	O	NBR
16	24	3		22060	W	A	OK	NBR
16	24	3		34470	W	A	O	FKM
16	24	3		110711	W	B	O	NBR
16	24	4		18519	W	B		NBR
16	24	4		56750	W	A		FKM
16	24	4		19575	W	A	OK	NBR
16	24	5		19576	W	A	OK	NBR
16	24	5		16850	W	A		NBR
16	24	5		62628	W	A		FKM
16	24	6		16851	W	B		NBR
16	24	6		175689	W	A	S	NBR
16	24	6		18520	W	A		NBR
16	24	6.5		18521	W	A	S	NBR
16	24	7		126759	W	A	S	NBR
16	24	7		16852	W	A		NBR
16	24	7		20251	W	B		NBR





油封

尺寸



d1	d2	H	H2	产品编码	产品组	设计型号	形式	材质
16	24	7		62629	W	A		FKM
16	24	7		175385	W	A	SY	FKM
16	24	7.5		18522	W	B		NBR
16	25	3		22061	W	A	OK	NBR
16	25	4		56910	W	B	O	NBR
16	25	7		64434	W	A		NBR
16	25.5	6		18615	W	A		NBR
16	26	5		39342	W	A		NBR
16	26	6		39189	W	A		NBR
16	26	6		130948	W	A	S	NBR
16	26	7		18617	W	A	S	NBR
16	26	7		150473	W	A	SY	NBR
16	26	7		56730	W	A		FKM
16	26	7		18616	W	A		NBR
16	26	7		18618	W	B		NBR
16	26	8		39343	W	A		NBR
16	26	8		18619	W	A	S	NBR
16	26.7	7		39345	W	A	S	NBR
16	28	6		39347	W	A		NBR
16	28	7		44956	W	B		FKM
16	28	7		130840	W	A		FKM
16	28	7		56751	W	A	S	FKM
16	28	7		18620	W	B	S	NBR
16	28	7		16854	W	A	S	NBR
16	28	7		16853	W	A		NBR
16	28	7		20272	W	A		FKM
16	28	7		152183	W	A	SY	FKM
16	28	7		157290	W	A	SY	NBR
16	28	7		38644	W	B		NBR
16	28	8		39348	W	A	S	NBR
16	28.65	6.3		57048	W	A	S	NBR
16	28.65	7		57049	W	A	S	NBR
16	28.7	8		39346	W	A	S	NBR
16	28.7	12.8		41384	W	B	S	NBR
16	29	9.5		39349	W	A		NBR
16	29	10		62574	W	A		FKM
16	30	4.5		16855	W	B		NBR
16	30	4.5		18621	W	A		NBR
16	30	4.5		62585	W	A	S	FKM
16	30	6		38978	W	A	S	NBR
16	30	7		57210	W	B		FKM
16	30	7		18622	W	A	S	NBR
16	30	7		16856	W	A		NBR
16	30	7		16857	W	B		NBR
16	30	7		82355	W	B	S	NBR
16	30	7		129972	W	A	SY	NBR
16	30	7		20273	W	A		FKM
16	30	8		38979	W	A	S	NBR
16	30	8		44220	W	A		NBR
16	30	8		44275	W	B		NBR
16	30	8		104208	W	A		FKM
16	30	10		16858	W	A		NBR
16	30	10		62579	W	A		FKM
16	30	10		16859	W	B		NBR
16	30	10		38738	W	C		NBR

Any seal. Any time.

www.dichtomatik.de



油封

尺寸

d1	d2	H	H2	产品编码	产品组	设计型号	形式	材质
16	32	6		39350	W	A		NBR
16	32	7		104319	W	A		FKM
16	32	7		16860	W	A		NBR
16	32	7		19688	W	B		NBR
16	32	7		38980	W	A	S	NBR
16	32	7		62496	W	A	S	FKM
16	32	8		83163	W	A		FKM
16	32	8		39351	W	A		NBR
16	32	10		16861	W	B		NBR
16	32	10		176980	W	A		NBR
16	32	10		62586	W	A		FKM
16	32	10		16862	W	C		NBR
16	32	10		38626	W	A		NBR
16	33	8		37244	W	A		NBR
16	33	11		19647	W	A		NBR
16	34	10		39829	W	A	S	NBR
16	35	6		18539	W	A		NBR
16	35	7		18511	W	A		NBR
16	35	7		18672	W	B		NBR
16	35	7		62497	W	A	S	FKM
16	35	7		60305	W	A		FKM
16	35	7		38981	W	A	S	NBR
16	35	7.5		41354	W	B		NBR
16	35	8		38982	W	A		NBR
16	35	9		36813	W	A	S	NBR
16	35	10		20274	W	A		FKM
16	35	10		18623	W	B		NBR
16	35	10		16863	W	A		NBR
16	36	7		39830	W	A		NBR
16	38	7		44236	W	A		NBR
16	40	5		39831	W	A		NBR
16	40	7		39832	W	A		NBR
16	40	10		38983	W	A	S	NBR
16	40	10		20476	W	A		FKM
16	40	10		150474	W	A	SY	FKM
16	40	10		16864	W	A		NBR
16	42	6		39833	W	A		NBR
16	42	7		39344	W	A	S	NBR
16	48	7		39834	W	A	S	NBR
16	52	7		38645	W	B		NBR
16.4	30	5		176779	W	A	S	FKM
16.5	28	8		38985	W	A	S	NBR
16.5	32	9		62587	W	A		FKM
16.5	32	9		19561	W	A		NBR
16.51	38.1	6.35		59671	W	A		NBR
16.67	34.92	7.93		60037	W	B		NBR
16.67	38.1	6.35		20799	W	A		NBR
16.67	40.08	6.35		59672	W	A		NBR
16.9	28	5		38984	W	A		NBR
16.94	35.2	10		162115	W	B	S	NBR
17	21	2.5		176532	W	B	O	NBR
17	21	3		39835	W	A	O	NBR
17	22	3		41221	W	B	O	NBR
17	23	3		39836	W	A	S	NBR
17	23	3		48949	W	A	O	FKM





油封

尺寸



d1	d2	H	H2	产品编码	产品组	设计型号	形式	材质
17	23	3		22062	W	A	OK	NBR
17	23	3		20942	W	B	O	NBR
17	23	4		57050	W	A	O	NBR
17	23	5		40473	W	A	O	NBR
17	23.5	3.2		162207	W	B	O	NBR
17	24	4		19577	W	A	OK	NBR
17	24	5		62630	W	A		FKM
17	24	7		62631	W	A		FKM
17	24	7		35092	W	A	O	NBR
17	24	7		16865	W	A		NBR
17	25	3		22063	W	A	OK	NBR
17	25	3		110710	W	B	O	NBR
17	25	4		48604	W	A		FKM
17	25	4		179162	W	A	S	NBR
17	25	4		179189	W	A	S	FKM
17	25	4		18624	W	A		NBR
17	25	5		179072	W	A		NBR
17	25	5		179074	W	A	S	NBR
17	25	7		38986	W	A		NBR
17	26	3		151375	W	A	OK	FKM
17	26	6		20737	W	A		FKM
17	26	6		18625	W	A		NBR
17	26	6		130806	W	A		FKM
17	26	7		18626	W	A		NBR
17	26	7		104209	W	A		FKM
17	27	5		18627	W	A		NBR
17	27	5		130949	W	A	S	NBR
17	27	6		62564	W	A		FKM
17	27	6		16866	W	A		NBR
17	27	7		62565	W	A		FKM
17	27	7		16867	W	A		NBR
17	27	8		38987	W	A	S	NBR
17	27	10		18628	W	A		NBR
17	27	10		18629	W	A	S	NBR
17	28	3.7		157865	W	B		NBR
17	28	5		16868	W	A		NBR
17	28	5		62568	W	A		FKM
17	28	5		18630	W	B		NBR
17	28	6		16869	W	A		NBR
17	28	6		56752	W	A	S	FKM
17	28	6		62569	W	A		FKM
17	28	6		16870	W	B		NBR
17	28	6		18631	W	A	S	NBR
17	28	6		157291	W	A	SY	NBR
17	28	6		48605	W	A	SY	FKM
17	28	7		37314	W	B	S	NBR
17	28	7		16873	W	B		NBR
17	28	7		130771	W	A		FKM
17	28	7		20275	W	A		FKM
17	28	7		157236	W	A	SY	FKM
17	28	7		16871	W	A		NBR
17	28	7		16872	W	A	S	NBR
17	28	7		62583	W	A	S	FKM
17	28	7		157292	W	A	SY	NBR
17	28	7.3		158176	W	B		NBR

Any seal. Any time.

www.dichtomatik.de



d1	d2	H	H2	产品编码	产品组	设计型号	形式	材质
17	28	8		20738	W	A		FKM
17	28	8		19486	W	A	S	NBR
17	28	8		38436	W	A		NBR
17	28.5	6		62573	W	A		FKM
17	28.5	6		19529	W	A		NBR
17	28.5	7		38988	W	A	S	NBR
17	28.65	7		38989	W	A	S	NBR
17	29	3.2		162216	W	B	O	NBR
17	29	5		57051	W	A	S	NBR
17	29	5		18632	W	A		NBR
17	29	7		18633	W	A	S	NBR
17	30	5		18634	W	A		NBR
17	30	5		83462	W	A	S	NBR
17	30	5		19581	W	A	OK	NBR
17	30	6		24350	W	A	SY	NBR
17	30	6		133558	W	A	SY	FKM
17	30	6		18635	W	A		NBR
17	30	6		18636	W	A	S	NBR
17	30	6		104210	W	A		FKM
17	30	7		16874	W	A		NBR
17	30	7		16875	W	A	S	NBR
17	30	7		130797	W	A		FKM
17	30	7		126041	W	A	SY	NBR
17	30	7		34254	W	A	S	FKM
17	30	7		126305	W	A		NBR
17	30	7		20276	W	A		FKM
17	30	7		16876	W	B		NBR
17	30	8		16877	W	A		NBR
17	30	8		44276	W	B		NBR
17	30	8		62580	W	A		FKM
17	30	8		18637	W	A	S	NBR
17	30	10		39837	W	A	S	NBR
17	30.5	7		39839	W	A	S	NBR
17	31	7		38990	W	A	S	NBR
17	31	7		16878	W	A		NBR
17	32	5		18706	W	A		NBR
17	32	5		144000	W	A	S	NBR
17	32	6		131119	W	A	O	NBR
17	32	6		39840	W	A	S	NBR
17	32	7		18707	W	B		NBR
17	32	7		16880	W	A	S	NBR
17	32	7		130643	W	A		NBR
17	32	7		20277	W	A		FKM
17	32	7		62498	W	A	S	FKM
17	32	7		16879	W	A		NBR
17	32	7.5		38991	W	A	S	NBR
17	32	7.5		83379	W	B		NBR
17	32	8		16881	W	A		NBR
17	32	8		18708	W	A	S	NBR
17	32	8		62588	W	A		FKM
17	32	8		131093	W	A	S	NBR
17	32	10		20278	W	A		FKM
17	32	10		16882	W	A		NBR
17	32	10		18709	W	B		NBR
17	32	10		16883	W	C		NBR



油封

尺寸



油封

尺寸



d1	d2	H	H2	产品编码	产品组	设计型号	形式	材质
17	33	7		16884	W	B		NBR
17	33	8		18710	W	A		NBR
17	33	8		39838	W	A	S	NBR
17	34	4		16885	W	B		NBR
17	34	4		38992	W	A		NBR
17	34	7		18711	W	A		NBR
17	34	7		38993	W	A	S	NBR
17	34.5	4		19594	W	A		NBR
17	34.5	4		62595	W	A		FKM
17	35	4		162608	W	A	O	FKM
17	35	5		19584	W	A	OK	NBR
17	35	5		18712	W	A		NBR
17	35	5		104211	W	A		FKM
17	35	5.5		40104	W	B		NBR
17	35	6		104212	W	A		FKM
17	35	6		18713	W	A		NBR
17	35	7		43719	W	A	SY	NBR
17	35	7		16887	W	A	S	NBR
17	35	7		157237	W	A	SY	FKM
17	35	7		22554	W	A		FKM
17	35	7		67463	W	A		NBR
17	35	7		16886	W	A		NBR
17	35	7		18714	W	B		NBR
17	35	7		179828	W	A	SY	NBR
17	35	8		62610	W	A	S	FKM
17	35	8		129975	W	A	SY	NBR
17	35	8		62602	W	A		FKM
17	35	8		18715	W	B		NBR
17	35	8		16888	W	A		NBR
17	35	8		16889	W	A	S	NBR
17	35	9		18716	W	A	S	NBR
17	35	9.5		18568	W	A		NBR
17	35	9.5		62603	W	A		FKM
17	35	10		16890	W	A		NBR
17	35	10		143999	W	A	S	NBR
17	35	10		44277	W	B		NBR
17	35	10		20279	W	A		FKM
17	35	10		16891	W	C		NBR
17	36	7		153248	W	A		FKM
17	37	4		83440	W	A		NBR
17	37	5		18717	W	A	S	NBR
17	37	7		104213	W	A		FKM
17	37	7		38994	W	A	S	NBR
17	37	7		16892	W	A		NBR
17	37	8		26386	W	A		NBR
17	37	10		62654	W	A		FKM
17	37	10		16893	W	A		NBR
17	37	10		18718	W	B		NBR
17	38	7		18719	W	A		NBR
17	38	7		18720	W	A	S	NBR
17	38	8		38995	W	A		NBR
17	38	11		62657	W	A		FKM
17	38	11		16894	W	A		NBR
17	39	9.5		35354	W	A	S	NBR
17	39	9.5		35375	W	A	S	FKM

Any seal. Any time.

www.dichtomatik.de



油封

尺寸

d1	d2	H	H2	产品编码	产品组	设计型号	形式	材质
17	40	6		16895	W	A		NBR
17	40	6		62665	W	A		FKM
17	40	7		124584	W	A		FKM
17	40	7		162373	W	A	S	FKM
17	40	7		16897	W	A	S	NBR
17	40	7		16899	W	B	S	NBR
17	40	7		60304	W	A		FKM
17	40	7		84232	W	B		NBR
17	40	7		134473	W	A	SY	FKM
17	40	7		16898	W	B		NBR
17	40	7		16896	W	A		NBR
17	40	8		18721	W	A		NBR
17	40	8		18722	W	A	S	NBR
17	40	8		104214	W	A		FKM
17	40	8.5		16900	W	A		NBR
17	40	8.5		19689	W	C		NBR
17	40	8.5		62666	W	A		FKM
17	40	10		16901	W	A		NBR
17	40	10		163339	W	B		NBR
17	40	10		38646	W	B		NBR
17	40	10		16902	W	C		NBR
17	40	10		62667	W	A		FKM
17	42	5		39841	W	A		NBR
17	42	7		69748	W	A		NBR
17	43	7		60303	W	B		NBR
17	47	7		18723	W	B		NBR
17	47	7		16903	W	A		NBR
17	47	7		20739	W	A		FKM
17	47	8		18724	W	A	S	NBR
17	47	8		104216	W	A		FKM
17	47	8		38996	W	A		NBR
17	47	10		104215	W	A		FKM
17	47	10		18725	W	A		NBR
17	47	10		18726	W	A	S	NBR
17	47	11		39842	W	A		NBR
17.27	28.44	9.52		56753	W	A		FKM
17.4	30	7		38997	W	A	S	NBR
17.46	22.22	3.17		60745	W	B	O	NBR
17.46	23.81	3.18		92938	W	A	O	NBR
17.46	25.4	3.17		60746	W	B	O	NBR
17.46	28.57	6.35		19885	W	A		NBR
17.46	28.57	6.35		131166	W	A	SY	FKM
17.46	28.57	6.35		156524	W	A		FKM
17.46	28.57	6.35		130465	W	A	SY	NBR
17.46	28.57	6.35		117746	W	A	S	NBR
17.46	30.16	8.13		60623	W	B	S	NBR
17.46	31.75	6.35		20013	W	A		NBR
17.46	31.75	6.35		59748	W	A	S	NBR
17.46	34.92	7.93		40105	W	B		NBR
17.46	34.92	9.52		60038	W	B		NBR
17.46	34.92	9.52		20014	W	A		NBR
17.5	20	6		19603	W	A		NBR
17.5	23.5	3.2		176950	W	A	OK	NBR
17.5	28	6		19672	W	A		NBR
17.5	28	6		62570	W	A		FKM





油封

尺寸



d1	d2	H	H2	产品编码	产品组	设计型号	形式	材质
17.5	41.9	3.5		176914	W	A		FKM
17.53	27.94	6.85		59673	W	A		NBR
17.78	38.1	7.52		59674	W	A		NBR
17.8	26.2	3.5		43705	W	A		NBR
18	24	3		22064	W	A	OK	NBR
18	24	3		48950	W	A	O	FKM
18	24	3		41222	W	B	O	NBR
18	24	4		19578	W	A	OK	NBR
18	24	5		83015	W	A		NBR
18	25	3		75201	W	A	O	NBR
18	25	4		39843	W	A	OK	NBR
18	25	4		18727	W	B		NBR
18	25	5		39845	W	A		NBR
18	25	6		21865	W	B		NBR
18	25.5	6		41223	W	B	O	NBR
18	26	4		22065	W	A	OK	NBR
18	26	4		179161	W	A		NBR
18	26	4		179163	W	A	S	NBR
18	26	5		39844	W	A	O	NBR
18	26	5		162402	W	A		FKM
18	26	6		38998	W	A		NBR
18	27	4		48931	W	A	O	NBR
18	27	5		18674	W	A		NBR
18	27	5		39846	W	A	O	NBR
18	28	4		62571	W	A		FKM
18	28	4		130869	W	A		FKM
18	28	4		38999	W	A		NBR
18	28	5		18728	W	A		NBR
18	28	6		18729	W	A		NBR
18	28	6		56754	W	A		FKM
18	28	6		18495	W	A	S	NBR
18	28	6		88212	W	A	S	FKM
18	28	7		20280	W	A		FKM
18	28	7		18730	W	A	S	NBR
18	28	7		152998	W	A	S	FKM
18	28	7		18731	W	B		NBR
18	28	7		16904	W	A		NBR
18	28	8		56755	W	A		FKM
18	28	8		18732	W	A	S	NBR
18	28.5	4.5		41224	W	B	O	NBR
18	29	7		18733	W	A	S	NBR
18	30	5		83441	W	A		NBR
18	30	6		118686	W	A	SY	NBR
18	30	6		20235	W	A	S	NBR
18	30	6		39847	W	A		NBR
18	30	6		150475	W	A	SY	FKM
18	30	7		131159	W	A	SY	NBR
18	30	7		157238	W	A	SY	FKM
18	30	7		27000	W	A		NBR
18	30	7		18734	W	A	S	NBR
18	30	7		18675	W	B		NBR
18	30	7		16905	W	A		NBR
18	30	7		20281	W	A		FKM
18	30	7		16906	W	B	S	NBR
18	30	7		73219	W	A	S	FKM

Any seal. Any time.

www.dichtomatik.de



d1	d2	H	H2	产品编码	产品组	设计型号	形式	材质
18	30	8		18735	W	A	S	NBR
18	30	10		60302	W	A		NBR
18	30.3	5		179889	W	A		NBR
18	31	7		18736	W	A	S	NBR
18	32	5		56756	W	A		FKM
18	32	6		175571	W	A	S	NBR
18	32	6		44454	W	A	SY	NBR
18	32	6		62589	W	A		FKM
18	32	6		19652	W	A		NBR
18	32	6		16907	W	A	S	NBR
18	32	6		62607	W	A	S	FKM
18	32	7		18676	W	B		NBR
18	32	7		18737	W	A		NBR
18	32	7		18738	W	A	S	NBR
18	32	7		40556	W	A	S	FKM
18	32	7		37245	W	A		NBR
18	32	7		20461	W	A		FKM
18	32	8		83096	W	A	S	FKM
18	32	8		35856	W	A	S	NBR
18	32	8		16909	W	B	S	NBR
18	32	8		16908	W	A		NBR
18	32	8		62590	W	A		FKM
18	32	10		18739	W	A		NBR
18	32	10		39848	W	A	S	NBR
18	35	5		39849	W	A		NBR
18	35	5		129806	W	A	SY	NBR
18	35	6		48608	W	A	SY	FKM
18	35	6		27036	W	A		NBR
18	35	6		104217	W	A		FKM
18	35	6	6.5	118687	W	A	SY	NBR
18	35	6		20224	W	A	S	NBR
18	35	7		16911	W	A	S	NBR
18	35	7		18740	W	B	S	NBR
18	35	7		16910	W	A		NBR
18	35	7		62499	W	A		FKM
18	35	7		62500	W	A	S	FKM
18	35	7		60301	W	B		NBR
18	35	8		18741	W	B		NBR
18	35	8		62604	W	A		FKM
18	35	8		16912	W	A		NBR
18	35	8		16913	W	A	S	NBR
18	35	8		129973	W	A	SY	NBR
18	35	10		36849	W	A		FKM
18	35	10		16914	W	A		NBR
18	35	10		89307	W	A	S	NBR
18	35	10		16915	W	C		NBR
18	36	7		39000	W	A		NBR
18	37	5		40474	W	A	O	NBR
18	37	6		39001	W	A		NBR
18	37	8		18742	W	A		NBR
18	37	8		18743	W	A	S	NBR
18	38	5		18744	W	A		NBR
18	38	7		18745	W	A	S	NBR
18	38	10		18746	W	A	S	NBR
18	40	7		16916	W	A		NBR



油封

尺寸



油封

尺寸



d1	d2	H	H2	产品编码	产品组	设计型号	形式	材质
18	40	7		44743	W	A		FKM
18	40	7		39002	W	A	S	NBR
18	40	10		16917	W	A		NBR
18	40	10		62639	W	A		FKM
18	40	10		39003	W	A	S	NBR
18	42	7		39068	W	A	S	NBR
18	42	8		16918	W	A		NBR
18	42	8		62676	W	A		FKM
18	42	10		26387	W	A		NBR
18	44	8		39850	W	A		NBR
18	47	10		18747	W	A		NBR
18	48	10		39852	W	A	O	NBR
18.5	40	5		39851	W	A		NBR
18.9	30	5		130785	W	A		NBR
18.9	30	7		19604	W	A		NBR
19	24	3		41225	W	B	O	NBR
19	25	4		179433	W	A	O	NBR
19	26	5		39853	W	A	O	NBR
19	26	5.5		18748	W	A		NBR
19	27	3.5		41226	W	B	O	NBR
19	27	4		22066	W	A	OK	NBR
19	27	5		38041	W	A	S	NBR
19	27	6		18749	W	B		NBR
19	27	6		179491	W	A	S	NBR
19	27	6		16919	W	A		NBR
19	27	6		62501	W	A		FKM
19	28	7		39855	W	A	O	NBR
19	28.7	5		39854	W	A	OK	NBR
19	29	5		39857	W	A		NBR
19	29	6.5		39858	W	A		NBR
19	30	3		41227	W	B	O	NBR
19	30	5		83377	W	A		NBR
19	30	6		40897	W	A		NBR
19	30	6.5		152997	W	A	S	FKM
19	30	6.5		39860	W	A	S	NBR
19	30	7		20367	W	A		FKM
19	30	7		80199	W	A	S	FKM
19	30	7		152184	W	A	SY	FKM
19	30	7		160520	W	A		NBR
19	30	7		39069	W	A		NBR
19	30	7		39070	W	A	S	NBR
19	30	8		18750	W	A		NBR
19	30	8		36626	W	B		NBR
19	30	8		39861	W	A	S	NBR
19	30	9		39859	W	A	S	NBR
19	30	10		39862	W	A		NBR
19	31	8		55977	W	A	S	NBR
19	32	5		39071	W	A		NBR
19	32	5		64549	W	A	S	NBR
19	32	6		16920	W	A		NBR
19	32	6		62591	W	A		FKM
19	32	7		62592	W	A		FKM
19	32	7		39072	W	A	S	NBR
19	32	7		21664	W	B		NBR
19	32	7		16921	W	A		NBR

Any seal. Any time.

www.dichtomatik.de



d1	d2	H	H2	产品编码	产品组	设计型号	形式	材质
19	32	8		18751	W	A	S	NBR
19	32	8		39863	W	A	O	NBR
19	32	10		16922	W	A		NBR
19	32	10	10.5	179078	W	A	SY	NBR
19	32	10		179075	W	A	S	NBR
19	32	10		62593	W	A	S	FKM
19	32.5	8		39864	W	A	S	NBR
19	33.3	8		39090	W	A	S	NBR
19	34	6		16923	W	A		NBR
19	34	6		62594	W	A		FKM
19	35	6		150476	W	A	SY	FKM
19	35	7		39091	W	A	S	NBR
19	35	7		56645	W	A	SY	FKM
19	35	7		56653	W	A		NBR
19	35	8		129974	W	A	SY	NBR
19	35	8		18752	W	A		NBR
19	35	8		18753	W	A	S	NBR
19	35	8		104219	W	A		FKM
19	35	10		104218	W	A		FKM
19	35	10		16924	W	A		NBR
19	36	7		39865	W	A		NBR
19	36	8		18754	W	A		NBR
19	37	10		104220	W	A		FKM
19	37	10		44221	W	A		NBR
19	37	10		16925	W	B		NBR
19	38	7		18755	W	A	S	NBR
19	38	9.5		39866	W	A		NBR
19	38	10		39867	W	A	S	NBR
19	38	10		26388	W	A		NBR
19	40	5		40475	W	B	O	NBR
19	40	7		179258	W	A		NBR
19	40	10		16926	W	A		NBR
19	40	10		39190	W	A	S	NBR
19	40	10		104221	W	A		FKM
19	44.5	8		39868	W	A		NBR
19	47	7		39092	W	A	S	NBR
19	47	8		39093	W	A	S	NBR
19	47	10		39094	W	A	S	NBR
19	47	10		56484	W	A		NBR
19	47	10.5		39869	W	A	S	NBR
19	53	7.5		19843	W	A		NBR
19.05	25.4	3.17		57052	W	B	O	NBR
19.05	25.4	4.76		83277	W	A		NBR
19.05	26	3.5		162212	W	B	O	NBR
19.05	27	4.6		60747	W	B	O	NBR
19.05	28.57	3.17		60748	W	B	O	NBR
19.05	28.57	4.76		60039	W	B		NBR
19.05	28.57	4.76		21856	W	A		NBR
19.05	28.57	6.35		59749	W	A	S	NBR
19.05	28.57	6.35		60040	W	B		NBR
19.05	28.57	6.35		34856	W	A		NBR
19.05	28.57	6.35		83164	W	A		FKM
19.05	28.57	6.35		19886	W	A		NBR
19.05	28.57	6.35		163105	W	A	SY	NBR
19.05	28.57	7.93		78748	W	A	S	NBR



油封

尺寸



油封

尺寸



d1	d2	H	H2	产品编码	产品组	设计型号	形式	材质
19.05	30.16	6.35		20015	W	A		NBR
19.05	30.16	6.35		149913	W	A	SY	NBR
19.05	31.75	3.17		60749	W	B	O	NBR
19.05	31.75	4.76		21117	W	A		NBR
19.05	31.75	4.76		60041	W	B		NBR
19.05	31.75	6.35		60750	W	B	O	NBR
19.05	31.75	6.35		19889	W	A		NBR
19.05	31.75	6.35		56757	W	A	S	FKM
19.05	31.75	6.35		78356	W	A		FKM
19.05	31.75	6.35		60624	W	B	S	NBR
19.05	31.75	6.35		21524	W	A	S	NBR
19.05	31.75	6.35		132902	W	A	SY	NBR
19.05	31.75	7.93		19890	W	A		NBR
19.05	31.75	7.93		59758	W	A	S	NBR
19.05	31.75	9.52		20016	W	A		NBR
19.05	33.33	6.35		20017	W	A		NBR
19.05	33.33	7.93		133546	W	A	SY	NBR
19.05	33.33	7.93		20018	W	A		NBR
19.05	34.92	6.35		60042	W	B		NBR
19.05	34.92	6.35		49491	W	A	S	NBR
19.05	34.92	6.35		19893	W	A		NBR
19.05	34.92	6.35		60625	W	B	S	NBR
19.05	34.92	7.93		19894	W	A		NBR
19.05	34.92	9.52		60043	W	B		NBR
19.05	34.92	9.52		20019	W	A		NBR
19.05	34.92	12.7		59759	W	A	S	NBR
19.05	38.1	6.35		19903	W	A		NBR
19.05	38.1	7.93		20020	W	A		NBR
19.05	38.1	7.93		60044	W	B		NBR
19.05	38.1	7.93		59760	W	A	S	NBR
19.05	38.1	9.52		59761	W	A	S	NBR
19.05	38.1	9.52		19901	W	A		NBR
19.05	38.1	9.52		60045	W	B		NBR
19.05	39.37	7.93		60830	W	C		NBR
19.05	41.27	6.35		59762	W	A	S	NBR
19.05	41.27	6.35		60626	W	B	S	NBR
19.05	41.27	7.93		20021	W	A		NBR
19.05	41.27	9.52		60046	W	B		NBR
19.05	41.27	9.52		20022	W	A		NBR
19.05	44.45	7.93		20804	W	A		NBR
19.05	44.45	7.93		59763	W	A	S	NBR
19.05	57.15	12.7		35307	W	A		NBR
19.05	63.5	12.7		60627	W	B	S	NBR
19.1	25.4	3		39871	W	A	O	NBR
19.2	28.57	6.35		59675	W	A		NBR
19.3	30	4.7		19547	W	A		NBR
19.45	31.5	4.76		60047	W	B		NBR
19.5	27	6		39856	W	A	S	NBR
19.5	28	6		39870	W	A		NBR
19.5	30	6		117905	W	A	SY	FKM
19.5	31	6		60300	W	B		NBR
19.6	33	9		19605	W	A		NBR
19.8	30	5		176778	W	A	S	FKM
19.8	52	8		19606	W	A	S	NBR
19.84	31.75	6.35		19867	W	A		NBR

Any seal. Any time.



d1	d2	H	H2	产品编码	产品组	设计型号	形式	材质
19.84	34.92	4.7		20023	W	A		NBR
19.84	38.1	7.9		20024	W	A		NBR
19.99	34.92	6.35		60048	W	B		NBR
20	24	2.5		82490	W	A	O	NBR
20	24	2.5		89238	W	B	O	NBR
20	25.45	4		41228	W	B	O	NBR
20	26	3		130457	W	A	OK	FKM
20	26	3		126429	W	B	O	NBR
20	26	4		56001	W	B	O	NBR
20	26	4		22067	W	A	OK	NBR
20	26	4		159843	W	B		FKM
20	26	4		163086	W	B	O	NBR
20	26	4		48951	W	A	O	FKM
20	26	4		18756	W	B		NBR
20	26	5		39095	W	A	S	NBR
20	26	10		26511	W	A	O	NBR
20	26	10		26389	W	A		NBR
20	28	3		110709	W	B	O	NBR
20	28	3.5		39872	W	A	O	NBR
20	28	4		131090	W	A	S	NBR
20	28	4		22068	W	A	OK	NBR
20	28	4		39096	W	A	S	NBR
20	28	4		19775	W	B	O	NBR
20	28	4		48952	W	A	OK	FKM
20	28	4.5		69238	W	A		NBR
20	28	4.5		39873	W	A	O	NBR
20	28	5		39874	W	A		NBR
20	28	6		18757	W	A		NBR
20	28	6		35205	W	B		FKM
20	28	6		179703	W	A	SY	FKM
20	28	6		130999	W	A	S	NBR
20	28	6		64959	W	B	S	NBR
20	28	6		62572	W	A		FKM
20	28	6		130769	W	A		FKM
20	28	7		104222	W	A		FKM
20	28	7		18758	W	A		NBR
20	28	7		39097	W	A	S	NBR
20	28	10		39875	W	A	O	NBR
20	29	9.5		41385	W	B	S	NBR
20	30	4		19776	W	B	O	NBR
20	30	4.5		74062	W	A	S	NBR
20	30	4.5		37678	W	A		FKM
20	30	4.5		18759	W	A		NBR
20	30	4.5		16927	W	B		NBR
20	30	4.5		118688	W	A	SY	NBR
20	30	4.6		72730	W	A		NBR
20	30	4.6		72731	W	A		FKM
20	30	5		16928	W	A		NBR
20	30	5		18760	W	B		NBR
20	30	5		157239	W	A	SY	FKM
20	30	5		175690	W	A	S	NBR
20	30	5		20762	W	A		FKM
20	30	5		39876	W	A	OK	NBR
20	30	5		39098	W	A	S	NBR
20	30	5		156460	W	A	O	NBR



油封

尺寸



油封

尺寸



d1	d2	H	H2	产品编码	产品组	设计型号	形式	材质
20	30	5		157293	W	A	SY	NBR
20	30	5		160820	W	A	S	NBR
20	30	6		18762	W	A	S	NBR
20	30	6		130876	W	B	S	NBR
20	30	6		18761	W	A		NBR
20	30	7		135005	W	A	S	FKM
20	30	7		131113	W	A	O	NBR
20	30	7		20282	W	A		FKM
20	30	7		89905	W	B	S	NBR
20	30	7		127001	W	A		FKM
20	30	7		131066	W	A	S	FKM
20	30	7		174548	W	A	SY	NBR
20	30	7		16929	W	A		NBR
20	30	7		16930	W	A	S	NBR
20	30	7		16931	W	B		NBR
20	30	7		157240	W	A	SY	FKM
20	30	7		160063	W	A	Y	FKM
20	30	7		133950	W	A	SY	NBR
20	30	7		38946	W	A	S	FKM
20	30	8		44242	W	A		NBR
20	30	8		104223	W	A		FKM
20	30	8		39878	W	A	S	NBR
20	30	9		39877	W	A		NBR
20	30	9		41355	W	B		NBR
20	30	10		179799	W	A	S	NBR
20	31	7		18764	W	B		NBR
20	31	7		38635	W	A	S	NBR
20	31	7		18763	W	A		NBR
20	31.2	7		57209	W	B		NBR
20	32	4		40476	W	A	O	NBR
20	32	5		41229	W	B	O	NBR
20	32	5		39879	W	A	S	NBR
20	32	5		126248	W	A	S	FKM
20	32	5		104224	W	A		FKM
20	32	5		18765	W	A		NBR
20	32	5		39880	W	A	O	NBR
20	32	6		39099	W	A	S	NBR
20	32	6		104225	W	A		FKM
20	32	6		39881	W	A		NBR
20	32	6		117544	W	B		NBR
20	32	6		135035	W	A	SY	FKM
20	32	6.5		39897	W	A	S	NBR
20	32	6.5		132610	W	A	SY	FKM
20	32	7		16932	W	A		NBR
20	32	7		16933	W	A	S	NBR
20	32	7		25717	W	A	S	FKM
20	32	7		44182	W	A		NBR
20	32	7		19691	W	B	S	NBR
20	32	7		20283	W	A		FKM
20	32	7		118689	W	A	SY	NBR
20	32	7		40505	W	A	O	NBR
20	32	7		16934	W	B		NBR
20	32	7		131069	W	A	S	FKM
20	32	7.5		39100	W	A	S	NBR
20	32	8		129976	W	A	SY	NBR

Any seal. Any time.



d1	d2	H	H2	产品编码	产品组	设计型号	形式	材质
20	32	8		18766	W	A	S	NBR
20	32	8.5		18767	W	B		NBR
20	32	12		40506	W	A	S	NBR
20	32.5	12		40507	W	A	S	NBR
20	33	7		161586	W	A		FKM
20	33	8		39089	W	A		NBR
20	33	9		16935	W	A		NBR
20	33	10		18768	W	A		NBR
20	33	10		22555	W	A		FKM
20	33	10		19692	W	B		NBR
20	34	6		18769	W	A		NBR
20	34	7		18770	W	A		NBR
20	34	7		18771	W	A	S	NBR
20	34	8		39101	W	A	S	NBR
20	35	4.5		18772	W	B	S	NBR
20	35	5		40508	W	A	S	NBR
20	35	5		19777	W	A	O	NBR
20	35	5		18773	W	A		NBR
20	35	5		104227	W	A		FKM
20	35	5.3		130832	W	A		NBR
20	35	5.5		39102	W	A	S	NBR
20	35	5.5		18774	W	A		NBR
20	35	6		18775	W	A	S	NBR
20	35	6		40509	W	A	OK	NBR
20	35	6		104226	W	A		FKM
20	35	6		24347	W	A	SY	NBR
20	35	6		16936	W	A		NBR
20	35	6		80966	W	A	SY	FKM
20	35	7		62611	W	A	S	FKM
20	35	7		44148	W	A		NBR
20	35	7		129823	W	A	S	FKM
20	35	7		127087	W	A	SY	NBR
20	35	7		16937	W	A		NBR
20	35	7		16938	W	A	S	NBR
20	35	7		178905	W	B	S	FKM
20	35	7		153204	W	A	SY	FKM
20	35	7		127002	W	A		FKM
20	35	7		40106	W	B	S	NBR
20	35	7		16939	W	B		NBR
20	35	7		20284	W	A		FKM
20	35	8		18776	W	A		NBR
20	35	8		18777	W	A	S	NBR
20	35	8		18778	W	B		NBR
20	35	8		62605	W	A		FKM
20	35	10		18780	W	B		NBR
20	35	10		127927	W	A	S	FKM
20	35	10		16941	W	C		NBR
20	35	10		18779	W	A	S	NBR
20	35	10		22556	W	A		FKM
20	35	10		16940	W	A		NBR
20	35	10		18496	W	B	S	NBR
20	35	12		16942	W	A		NBR
20	35	12		39103	W	A	S	NBR
20	35	13		39104	W	A	S	NBR
20	35.5	10		40510	W	A		NBR



油封

尺寸



油封

尺寸



d1	d2	H	H2	产品编码	产品组	设计型号	形式	材质
20	36	5		36567	W	A		NBR
20	36	6		36500	W	A		NBR
20	36	7		18781	W	A		NBR
20	36	7		18782	W	A	S	NBR
20	36	7		104228	W	A		FKM
20	36	8		115831	W	A		FKM
20	37	6		93130	W	B		NBR
20	37	6.5		41373	W	B		NBR
20	37	7		39106	W	A		NBR
20	37	7		21086	W	B		NBR
20	37	7		39105	W	A	S	NBR
20	37	8		18783	W	A	S	NBR
20	37	8		62655	W	A		FKM
20	37	8		121639	W	A		NBR
20	37	8		16943	W	A		NBR
20	37	10		104229	W	A		FKM
20	37	10		18784	W	A		NBR
20	37	10		18785	W	A	S	NBR
20	38	3		41282	W	A	S	NBR
20	38	5		18786	W	A		NBR
20	38	5		18787	W	A	S	NBR
20	38	6		39107	W	A		NBR
20	38	7		16944	W	A		NBR
20	38	7		16945	W	A	S	NBR
20	38	7		130870	W	A		FKM
20	38	7		62658	W	A		FKM
20	38	8		18788	W	A		NBR
20	38	8		18790	W	A	S	NBR
20	38	8		22557	W	A		FKM
20	38	8		16946	W	C		NBR
20	38	9		40511	W	A		NBR
20	38	10		18791	W	A	S	NBR
20	38.5	8		40512	W	A	S	NBR
20	40	5		173449	W	B		NBR
20	40	5		18792	W	A		NBR
20	40	6		16948	W	A		NBR
20	40	6		62668	W	A		FKM
20	40	6		34920	W	A	S	NBR
20	40	7		40107	W	B	S	NBR
20	40	7		16949	W	A		NBR
20	40	7		164052	W	A	SY	NBR
20	40	7		157212	W	A	SY	FKM
20	40	7		16951	W	B		NBR
20	40	7		22498	W	A	S	FKM
20	40	7		16950	W	A	S	NBR
20	40	7		20285	W	A		FKM
20	40	7		115552	W	B	Y	NBR
20	40	7		130778	W	A		FKM
20	40	8		17149	W	A	S	NBR
20	40	8.5		62669	W	A		FKM
20	40	8.5		16953	W	A		NBR
20	40	9		18794	W	A	S	NBR
20	40	9		18793	W	A		NBR
20	40	10		16954	W	A		NBR
20	40	10		16956	W	B	S	NBR

Any seal. Any time.



d1	d2	H	H2	产品编码	产品组	设计型号	形式	材质
20	40	10		16955	W	B		NBR
20	40	10		18795	W	A	S	NBR
20	40	10		20286	W	A		FKM
20	40	10		16957	W	C		NBR
20	40	10		177612	W	A	S	FKM
20	40	11		129977	W	A	SY	NBR
20	40	11		39108	W	A	S	NBR
20	40	11		40513	W	A		NBR
20	40.2	6		62674	W	A		FKM
20	40.2	6		18830	W	A		NBR
20	41	8		40514	W	A		NBR
20	41.2	5		39109	W	A	S	NBR
20	41.2	6		39110	W	A		NBR
20	42	6		62677	W	A		FKM
20	42	6		83464	W	A	S	NBR
20	42	6		40515	W	A	O	NBR
20	42	7		16958	W	A		NBR
20	42	7		74985	W	A	SY	FKM
20	42	7		176982	W	A		NBR
20	42	7		18796	W	A	S	NBR
20	42	7		16959	W	B		NBR
20	42	7		40662	W	C		NBR
20	42	7		62502	W	A	S	FKM
20	42	7		92760	W	B		FKM
20	42	7		42464	W	B	S	FKM
20	42	7		19693	W	B	S	NBR
20	42	7		20287	W	A		FKM
20	42	8		18797	W	A	S	NBR
20	42	10		16961	W	B		NBR
20	42	10		22558	W	A		FKM
20	42	10		16960	W	A		NBR
20	42	10		16962	W	C		NBR
20	42	10		39111	W	A	S	NBR
20	42	12		40516	W	A	S	NBR
20	43	7.5		62687	W	A		FKM
20	43	7.5		16963	W	A		NBR
20	43	8.5		163099	W	C	S	NBR
20	45	7		39112	W	A	S	NBR
20	45	8		18798	W	A	S	NBR
20	45	10		62856	W	A		FKM
20	45	10		16964	W	A		NBR
20	45	12		18799	W	A		NBR
20	46	6		39113	W	A		NBR
20	46	8		18800	W	A	S	NBR
20	47	5		39114	W	A	S	NBR
20	47	7		16967	W	B		NBR
20	47	7		62866	W	A	S	FKM
20	47	7		66230	W	A	S	FKM
20	47	7		20288	W	A		FKM
20	47	7		124594	W	A		FKM
20	47	7		40661	W	C		NBR
20	47	7		16965	W	A		NBR
20	47	7		16966	W	A	S	NBR
20	47	7		179397	W	A		NBR
20	47	7		176007	W	A		NBR



油封

尺寸



油封

尺寸



d1	d2	H	H2	产品编码	产品组	设计型号	形式	材质
20	47	7		130658	W	A		NBR
20	47	8		62867	W	A		FKM
20	47	8		16968	W	A		NBR
20	47	8		18801	W	A	S	NBR
20	47	8.5		18802	W	A		NBR
20	47	9		18803	W	A		NBR
20	47	9		18804	W	A	S	NBR
20	47	9.5		60298	W	A		NBR
20	47	10		18805	W	A	S	NBR
20	47	10		16969	W	A		NBR
20	47	10		16971	W	B	S	NBR
20	47	10		16970	W	B		NBR
20	47	10		16972	W	C		NBR
20	47	10		20289	W	A		FKM
20	47	12		18806	W	A	S	NBR
20	47.5	7		62897	W	A	S	FKM
20	48	9		62898	W	A		FKM
20	48	9		19796	W	A		NBR
20	48.4	7		83442	W	A		NBR
20	49	7		163110	W	A	S	NBR
20	52	7		18807	W	A		NBR
20	52	7		16973	W	B		NBR
20	52	7		22559	W	A		FKM
20	52	7		39115	W	A	S	NBR
20	52	8		18808	W	A		NBR
20	52	8		18809	W	A	S	NBR
20	52	9		18810	W	A	S	NBR
20	52	10		16975	W	B		NBR
20	52	10		16976	W	C		NBR
20	52	10		62913	W	A		FKM
20	52	10		130844	W	A		FKM
20	52	10		16974	W	A		NBR
20	52	10		95601	W	A	S	NBR
20	52	12		27677	W	A		NBR
20	54	7		39116	W	A	S	NBR
20	55	7		179789	W	A	S	NBR
20	57	8		40517	W	A		NBR
20	60	10		40660	W	A		NBR
20	62	6.5		18811	W	A		NBR
20	62	10		39117	W	A	S	NBR
20	72	5		44544	W	A		NBR
20	72	10		43740	W	A		NBR
20.5	41.9	4		177725	W	A		FKM
20.63	30.16	6.35		21153	W	A		NBR
20.63	30.8	4.6		83463	W	A	S	NBR
20.63	31.75	6.35		59765	W	A	S	NBR
20.63	31.75	6.35		152317	W	A	S	FKM
20.63	31.75	9.52		60831	W	C		NBR
20.63	34.92	6.35		19895	W	A		NBR
20.63	34.92	7.93		60628	W	B	S	NBR
20.63	34.92	9.52		19896	W	A		NBR
20.63	38.1	6.35		20244	W	A		NBR
21	27	3		40518	W	A	○	NBR
21	28	5		41230	W	B	○	NBR
21	28	5.5		75080	W	B	○	NBR

Any seal. Any time.



d1	d2	H	H2	产品编码	产品组	设计型号	形式	材质
21	29	4		22069	W	A	OK	NBR
21	30	6.5		16977	W	A		NBR
21	30	6.5		62581	W	A		FKM
21	30	6.5		18812	W	B		NBR
21	31	5		40522	W	A	S	NBR
21	32	5		18813	W	A		NBR
21	32	5		18814	W	B		NBR
21	32	7		16978	W	A		NBR
21	32	7		163770	W	A		NBR
21	32	8		40519	W	A	S	NBR
21	33	7		40520	W	A	O	NBR
21	33	8		163106	W	A	SY	NBR
21	35	6		18815	W	A		NBR
21	35	7		18816	W	A	S	NBR
21	35	7		16979	W	A		NBR
21	35	8		39120	W	A		NBR
21	35	10		26390	W	A		NBR
21	35	13		18817	W	A	S	NBR
21	37	6		41231	W	B	O	NBR
21	37	7		18818	W	A		NBR
21	40	5		40523	W	A		NBR
21	40	7		131003	W	A	S	NBR
21	40	7		18819	W	A	S	NBR
21	40	10		18820	W	A		NBR
21	48	8		19797	W	A		NBR
21	52	8		39121	W	A		NBR
21.3	32	5		40521	W	A		NBR
21.6	35	8		19607	W	A	S	NBR
21.8	35.3	7		163111	W	A	S	NBR
22	28	4		61768	W	B	O	NBR
22	28	4		22070	W	A	OK	NBR
22	28	4.5		75912	W	A	O	NBR
22	28	5		80411	W	A	O	NBR
22	28.5	4		40524	W	A	OK	NBR
22	29	4		83734	W	A	OK	NBR
22	30	4		48953	W	A	O	FKM
22	30	4		22071	W	A	OK	NBR
22	30	4		61769	W	B	O	NBR
22	30	4		179230	W	A	O	NBR
22	30	5		40525	W	A	O	NBR
22	30	7		39118	W	A	S	NBR
22	30	7		38561	W	A		NBR
22	30	7		83165	W	A		FKM
22	30	7		18821	W	B		NBR
22	30	8		39119	W	A	S	NBR
22	30	10		26512	W	A	O	NBR
22	30	10		26391	W	A		NBR
22	31	5		18822	W	A		NBR
22	31	6.5		124966	W	A	SY	NBR
22	31.5	4.5		41232	W	B	O	NBR
22	31.8	5		40526	W	A		NBR
22	32	4		26488	W	A		NBR
22	32	4.5		40527	W	A	O	NBR
22	32	4.5		126054	W	A	S	NBR
22	32	5		18823	W	A		NBR



油封

尺寸



油封

尺寸



d1	d2	H	H2	产品编码	产品组	设计型号	形式	材质
22	32	5.5		20290	W	A		FKM
22	32	5.5		16980	W	A		NBR
22	32	5.6		56758	W	A		FKM
22	32	6		18824	W	B		NBR
22	32	6		78169	W	A	SY	NBR
22	32	7		16981	W	A		NBR
22	32	7		16982	W	B		NBR
22	32	7		48609	W	A	S	FKM
22	32	7		78156	W	B	S	NBR
22	32	7		157241	W	A	SY	FKM
22	32	7		157294	W	A	SY	NBR
22	32	7		160537	W	A		NBR
22	32	7		130815	W	A		FKM
22	32	7		18825	W	A	S	NBR
22	32	7		20291	W	A		FKM
22	32	7		118734	W	A		FKM
22	32	7		118731	W	A		NBR
22	32	8		34931	W	A	S	NBR
22	32	10		44243	W	A		NBR
22	32	10		104230	W	A		FKM
22	33	6.5		18826	W	A	S	NBR
22	33	7		20236	W	A		NBR
22	34	7		39122	W	A		NBR
22	34	7		130996	W	A	S	NBR
22	35	5		18827	W	A	S	NBR
22	35	5.5		18528	W	A		NBR
22	35	5.5		62606	W	A		FKM
22	35	5.6		39123	W	A		NBR
22	35	6		24348	W	A	SY	NBR
22	35	6		18829	W	A	S	NBR
22	35	6		128168	W	A	SY	FKM
22	35	6		104231	W	A		FKM
22	35	6		18828	W	A		NBR
22	35	6.5		16844	W	A		NBR
22	35	6.5		62647	W	A		FKM
22	35	7		16984	W	A	S	NBR
22	35	7		16987	W	B		NBR
22	35	7		38681	W	B	S	NBR
22	35	7		83191	W	A	S	FKM
22	35	7		130521	W	A	SY	NBR
22	35	7		20292	W	A		FKM
22	35	7		16983	W	A		NBR
22	35	8		18831	W	A	S	NBR
22	35	8		129978	W	A	SY	NBR
22	35	8		22560	W	A		FKM
22	35	8		16985	W	A		NBR
22	35	8		18832	W	B		NBR
22	35	10		16988	W	A	S	NBR
22	35	10		18834	W	B		NBR
22	35	10		18835	W	B	S	NBR
22	35	10		16986	W	A		NBR
22	35	10		62648	W	A		FKM
22	35.3	7		163112	W	A	S	NBR
22	36	6		39124	W	A		NBR
22	36	7		18836	W	A		NBR

Any seal. Any time.



d1	d2	H	H2	产品编码	产品组	设计型号	形式	材质
22	36	8		39125	W	A	S	NBR
22	36	9		41386	W	B	S	NBR
22	36	10		39126	W	A	S	NBR
22	36.5	7		40529	W	A	S	NBR
22	37	7		16989	W	A		NBR
22	37	7		18837	W	A	S	NBR
22	37	7		18677	W	B		NBR
22	37	7		104232	W	A		FKM
22	37	8.5		35897	W	A	S	NBR
22	38	6		18838	W	A	S	NBR
22	38	6		39127	W	A		NBR
22	38	7		39128	W	A	S	NBR
22	38	7		16991	W	A		NBR
22	38	7		20293	W	A		FKM
22	38	8		18839	W	A		NBR
22	38	8		104233	W	A		FKM
22	38	8		18840	W	A	S	NBR
22	39	6		131078	W	A	S	NBR
22	40	5		40530	W	A	S	NBR
22	40	5		45802	W	A		FKM
22	40	7		16992	W	A		NBR
22	40	7		20294	W	A		FKM
22	40	7		56763	W	A	S	FKM
22	40	7		144381	W	A	S	NBR
22	40	7		18841	W	B	S	NBR
22	40	7		16993	W	A	S	NBR
22	40	7		38647	W	B		NBR
22	40	7		130761	W	A		FKM
22	40	8		104234	W	A		FKM
22	40	8		18842	W	A		NBR
22	40	8		143688	W	A	SY	NBR
22	40	8		18843	W	A	S	NBR
22	40	8		19695	W	B		NBR
22	40	8.5		16994	W	A		NBR
22	40	8.5		62670	W	A		FKM
22	40	8.5		19696	W	B		NBR
22	40	10		16995	W	A		NBR
22	40	10		56764	W	A		FKM
22	40	10		177613	W	A	S	FKM
22	40	10		16996	W	B		NBR
22	40	10		35082	W	A	S	NBR
22	40	10		16997	W	C		NBR
22	40	11		18844	W	A	S	NBR
22	40	16		39129	W	A	S	NBR
22	41.25	6		40108	W	B	S	NBR
22	41.25	6		39130	W	A	S	NBR
22	41.5	7		40109	W	B	S	NBR
22	42	5		40531	W	A		NBR
22	42	7		18845	W	A	S	NBR
22	42	7		62678	W	A		FKM
12	22	6		156655	W	A	SY	FKM
22	42	7		16998	W	A		NBR
22	42	8		39131	W	A	S	NBR
22	42	10		39132	W	A	S	NBR
22	42	10		16999	W	A		NBR



油封

尺寸



油封

尺寸



d1	d2	H	H2	产品编码	产品组	设计型号	形式	材质
22	42	10		20295	W	A		FKM
22	42	10		17000	W	C		NBR
22	42	10		18846	W	B		NBR
22	42	10		40110	W	B	S	NBR
22	42	11		18848	W	A	S	NBR
22	42	11		41422	W	C	S	NBR
22	42	11		129979	W	A	SY	NBR
22	42	11		18847	W	A		NBR
22	42	12		40532	W	A	S	NBR
22	43	15		41356	W	B		NBR
22	45	7		39133	W	A	S	NBR
22	45	7		62857	W	A		FKM
22	45	7		17001	W	A		NBR
22	45	8		56821	W	A		NBR
22	45	8		17002	W	B		NBR
22	45	8		39134	W	A	S	NBR
22	45	10		39135	W	A		NBR
22	45	11		40533	W	A	S	NBR
22	47	7		18849	W	A		NBR
22	47	7		153104	W	A	SY	NBR
22	47	7		127003	W	A		FKM
22	47	7		20740	W	A		FKM
22	47	7		60296	W	B		NBR
22	47	7		161501	W	A	S	FKM
22	47	7		38636	W	A	S	NBR
22	47	9		17004	W	C		NBR
22	47	10		17005	W	A		NBR
22	47	10		39136	W	A	S	NBR
22	47	10		17006	W	B		NBR
22	47	10		104235	W	A		FKM
22	47	10		17007	W	C		NBR
22	48	5		39137	W	A		NBR
22	48	7		39138	W	A	S	NBR
22	48	10		19798	W	A		NBR
22	48	11		39139	W	A	S	NBR
22	52	10		62914	W	A	S	FKM
22	52	10		19802	W	A	S	NBR
22	56	8		179432	W	A	S	NBR
22	62	12		40534	W	A	S	NBR
22.2	28.5	3		153022	W	B	O	NBR
22.2	28.7	3		41233	W	B	O	NBR
22.22	28.57	3.17		60751	W	B	O	NBR
22.22	28.57	4.76		60050	W	B		NBR
22.22	28.57	6.35		60049	W	B		NBR
22.22	31.75	4.76		20797	W	A		NBR
22	42	7		160092	W	A	SY	FKM
22.22	31.75	6.35		60051	W	B		NBR
22.22	31.75	6.35		20240	W	A		NBR
22.22	31.75	7.93		20241	W	A		NBR
22.22	34.92	4.76		60752	W	B	O	NBR
22.22	34.92	4.76		20243	W	A		NBR
22.22	34.92	6.35		38250	W	A		FKM
22.22	34.92	6.35		60629	W	B	S	NBR
22.22	34.92	6.35		20025	W	A		NBR
22.22	34.92	6.35		44130	W	A	S	NBR

Any seal. Any time.



d1	d2	H	H2	产品编码	产品组	设计型号	形式	材质
22.22	34.92	6.35		60052	W	B		NBR
22.22	34.92	7.93		19897	W	A		NBR
22.22	34.92	9.52		19898	W	A		NBR
22.22	35.15	9.52		56762	W	A	S	FKM
22.22	35.15	9.52		56761	W	A		FKM
22.22	38.1	6.35		49492	W	A	S	NBR
22.22	38.1	6.35		60630	W	B	S	NBR
22.22	38.1	6.35		19902	W	A		NBR
22.22	38.1	7.93		20026	W	A		NBR
22.22	38.1	9.52		60053	W	B		NBR
22.22	38.1	9.52		60631	W	B	S	NBR
22.22	38.1	9.52		59766	W	A	S	NBR
22.22	38.1	9.52		19904	W	A		NBR
22.22	40.01	6.35		60054	W	B		NBR
22.22	41.27	9.52		19908	W	A		NBR
22.22	41.27	9.52		59767	W	A	S	NBR
22.22	44.45	9.52		20805	W	A		NBR
22.22	47.62	6.35		45066	W	A	S	NBR
22.22	47.62	9.52		59768	W	A	S	NBR
22.22	47.62	9.52		20808	W	A		NBR
22.22	47.62	11.11		35743	W	A	S	NBR
22.22	50.8	9.52		20812	W	A		NBR
23	28	3		73958	W	B	O	NBR
23	28	3		88218	W	A	O	NBR
23	30	4		41235	W	B	O	NBR
23	31	5		40535	W	A	O	NBR
23	31.8	7		41374	W	B		NBR
23	32	5		39140	W	A	S	NBR
23	32	5		41234	W	B	O	NBR
23	32	5		40111	W	B		NBR
23	35	6		18851	W	A	S	NBR
23	35	6		18850	W	A		NBR
23	35	7		17008	W	A		NBR
23	35	7		18852	W	A	S	NBR
23	37	6		39141	W	A		NBR
23	37	6		179874	W	A	SY	NBR
23	37	7		39143	W	A		NBR
23	38	7		17009	W	A		NBR
23	38	7		39142	W	A	S	NBR
23	38	7		62659	W	A		FKM
23	38	8		62660	W	A		FKM
23	38	8		17010	W	A		NBR
23	40	6		18853	W	A	S	NBR
23	40	7		74569	W	B	S	NBR
23	40	7		39144	W	A	S	NBR
23	40	8		39145	W	A	S	NBR
23	40	8		18854	W	A		NBR
23	40	10		17011	W	A		NBR
23	40	10		17012	W	B		NBR
23	40	10		104236	W	A		FKM
23	40	10		17013	W	C		NBR
23	40	10		39180	W	A	S	NBR
23	42	6		125106	W	A	S	NBR
23	42	10		39191	W	A	S	NBR
23	42	10		38627	W	A		NBR



油封

尺寸



油封

尺寸



d1	d2	H	H2	产品编码	产品组	设计型号	形式	材质
23	42	10		17014	W	C		NBR
23	42	11		39146	W	A	S	NBR
23	42	11		129980	W	A	SY	NBR
23	45	11		40536	W	A	S	NBR
23	47	7		18855	W	A	S	NBR
23	47	10		61834	W	A	S	NBR
23	48	10		18856	W	A	S	NBR
23	52	11		40537	W	A	S	NBR
23	52	12		62915	W	A		FKM
23	52	12		19803	W	A		NBR
23	55	7		39147	W	A	S	NBR
23.81	36.51	6.35		56765	W	A		FKM
23.81	36.51	6.35		43747	W	A		NBR
23.81	38.1	6.35		60632	W	B	S	NBR
23.81	38.1	9.52		59769	W	A	S	NBR
23.81	38.1	9.52		19905	W	A		NBR
23.81	41.27	6.35		60055	W	B		NBR
23.81	41.27	9.52		75248	W	B		NBR
23.81	42.86	7.93		75025	W	B	S	NBR
23.81	44.45	7.93		35746	W	A	S	NBR
23.81	44.45	9.52		20027	W	A		NBR
24	30	3		80829	W	B	O	NBR
24	32	4		127415	W	B	O	NBR
24	32	4		22072	W	A	OK	NBR
24	32	4		163391	W	A	S	NBR
24	32	5		39054	W	B	O	NBR
24	32	5		40538	W	A		NBR
24	32	7		35979	W	B	S	NBR
24	32	7		164369	W	A	O	FKM
24	33	4		40477	W	A	O	NBR
24	33	5		124844	W	A		NBR
24	34	5.5		18857	W	A		NBR
24	35	5		41358	W	B		NBR
24	35	6		18858	W	A		NBR
24	35	6		179798	W	B		NBR
24	35	6		39148	W	A	S	NBR
24	35	6		73220	W	A		FKM
24	35	7		17015	W	A		NBR
24	35	7		21595	W	B		NBR
24	35	7		38637	W	A	S	NBR
24	35	7		62503	W	A		FKM
24	35	8		18859	W	A	S	NBR
24	36	5		18860	W	B		NBR
24	36	6		18861	W	A		NBR
24	36	7		20462	W	A		FKM
24	36	7		130982	W	A	S	FKM
24	36	7		18862	W	A	S	NBR
24	36	7		22107	W	A	S	FKM
24	36	7		43758	W	A		NBR
24	36	9		18863	W	B		NBR
24	37	5		131092	W	A	S	NBR
24	37	7		39149	W	A	S	NBR
24	37	7		17016	W	A		NBR
24	37	7		62504	W	A		FKM
24	37	7		18864	W	B		NBR

Any seal. Any time.



d1	d2	H	H2	产品编码	产品组	设计型号	形式	材质
24	37	9		40362	W	C		NBR
24	38	7		39150	W	A	S	NBR
24	38	8		18865	W	A	S	NBR
24	38	8.5		39151	W	A	S	NBR
24	38	10		22561	W	A		FKM
24	38	10		39152	W	A	S	NBR
24	38	10		41357	W	B		NBR
24	38.5	10		56766	W	A		FKM
24	38.5	10		22499	W	A	S	FKM
24	38.5	10		18866	W	A		NBR
24	39	8		40539	W	A		NBR
24	40	6		24352	W	A	SY	NBR
24	40	6		80967	W	A	SY	FKM
24	40	7		20296	W	A		FKM
24	40	7		116485	W	A	SY	NBR
24	40	7		17018	W	A	S	NBR
24	40	7		62688	W	A	S	FKM
24	40	7		17017	W	A		NBR
24	40	7		76564	W	B		NBR
24	40	7		157242	W	A	SY	FKM
24	40	8		39153	W	A	S	NBR
24	40	8		38628	W	A		NBR
24	40	8		129981	W	A	SY	NBR
24	40	10		17019	W	A		NBR
24	40	10		39154	W	A	S	NBR
24	40	10		20297	W	A		FKM
24	40	10		17020	W	B		NBR
24	40	10		38737	W	C		NBR
24	40	11		17021	W	A		NBR
24	40	12		40540	W	A		NBR
24	41	10		40541	W	A	S	NBR
24	42	7		39155	W	A		NBR
24	42	7		104238	W	A		FKM
24	42	7		39156	W	A	S	NBR
24	42	8		62679	W	A		FKM
24	42	8		39157	W	A	S	NBR
24	42	8		17022	W	A		NBR
24	42	10		39158	W	A	S	NBR
24	42	10		72635	W	C		NBR
24	42	10		104237	W	A		FKM
24	42	10		18867	W	A		NBR
24	42	10		17023	W	C		NBR
24	44	6		40542	W	A		NBR
24	44	7		18868	W	A		NBR
24	45	7		39159	W	A	S	NBR
24	45	7		48611	W	A		FKM
24	45	8		40543	W	A	S	NBR
24	45	10		40112	W	B	S	NBR
24	46	10		39160	W	A	S	NBR
24	47	7		18678	W	B		NBR
24	47	7		62868	W	A		FKM
24	47	7		176096	W	A		NBR
24	47	7		17024	W	A		NBR
24	47	7		17025	W	A	S	NBR
24	47	7		164719	W	A	S	FKM



油封



尺寸





油封

尺寸



d1	d2	H	H2	产品编码	产品组	设计型号	形式	材质
24	47	7		126226	W	A	SY	NBR
24	47	8		39161	W	A	S	NBR
24	47	10		176981	W	A		NBR
24	47	10		24203	W	A	S	NBR
24	47	10		62869	W	A		FKM
24	47	10		17026	W	A		NBR
24	48	10		39162	W	A		NBR
24	48	11		18869	W	B	S	NBR
24	49	12		40544	W	A	S	NBR
24	50	10		40545	W	A	S	NBR
24	50	10		39163	W	A		NBR
24	51	7		18870	W	A	S	NBR
24	52	7		18871	W	A	S	NBR
24	52	10		40546	W	A	S	NBR
24	52	10		62916	W	A		FKM
24	52	10		61142	W	A		NBR
24	52	11		40547	W	A	S	NBR
24	54	14		40548	W	A	S	NBR
24	62	7		19851	W	A		NBR
24.13	34.52	6.99		60056	W	B		NBR
24.5	28.5	2.5		41238	W	B	O	NBR
24.5	29.8	4		40549	W	A	O	NBR
24.5	33	5		43755	W	A		NBR
24.5	40	8.5		56767	W	A		FKM
24.5	40	8.5		56980	W	A		NBR
24.5	47.62	6.35		156934	W	A		NBR
24.61	35.71	6.35		60633	W	B	S	NBR
24.61	52.02	9.52		60057	W	B		NBR
24.61	54.28	9.52		134000	W	A	SY	FKM
24.68	35	8.5		57053	W	A	S	NBR
24.7	30	4		80516	W	B	O	NBR
24.8	44.45	7.9		148811	W	A	SY	NBR
24.87	34.92	6.83		60753	W	A		NBR
24.9	45	6.5		19608	W	A		NBR
24.99	38.07	6.35		60634	W	B	S	NBR
24.99	38.07	6.35		59770	W	A	S	NBR
25	31	2.5		65028	W	B	O	NBR
25	31	4		40551	W	A	O	NBR
25	31	5		40552	W	A	OK	NBR
25	32	3		41241	W	B	O	NBR
25	32	4		41242	W	B	O	NBR
25	32	4		22073	W	A	OK	NBR
25	32	4		64955	W	B		FKM
25	32	4		127078	W	B	O	FKM
25	32	4		84933	W	A	O	FKM
25	32	4.5		41239	W	B	O	NBR
25	32	5		19778	W	B	O	NBR
25	32	5		90142	W	B		FKM
25	32	6		62609	W	A	S	FKM
25	32	6		17028	W	A	S	NBR
25	32	6		83166	W	A		FKM
25	32	6		18872	W	A		NBR
25	32	7		104239	W	A		FKM
25	32	7		46411	W	A	S	NBR
25	32	7		72652	W	B		NBR

Any seal. Any time.



d1	d2	H	H2	产品编码	产品组	设计型号	形式	材质
25	32	7		69980	W	B	S	NBR
25	32	7		41240	W	B	O	NBR
25	32	7		18873	W	A		NBR
25	33	4		18874	W	A		NBR
25	33	4		41237	W	B	O	NBR
25	33	4		22074	W	A	OK	NBR
25	33	4		124801	W	A		FKM
25	33	6		18875	W	A		NBR
25	33	6		40554	W	A	O	NBR
25	33	6		39210	W	A		FKM
25	33	6		34898	W	A	SY	NBR
25	33	8		40555	W	A	O	NBR
25	34	5		18876	W	B		NBR
25	34	7		40113	W	B	S	NBR
25	34	10		41359	W	B		NBR
25	35	4		37877	W	B		NBR
25	35	4		129868	W	B	O	NBR
25	35	4		48954	W	A	O	FKM
25	35	4		22075	W	A	OK	NBR
25	35	5		17029	W	A		NBR
25	35	5		18878	W	B		NBR
25	35	5		72722	W	A	S	FKM
25	35	5		18877	W	A	S	NBR
25	35	5		104240	W	A		FKM
25	35	6		41243	W	B	O	NBR
25	35	6		48612	W	A	SY	FKM
25	35	6		18880	W	B		NBR
25	35	6		18879	W	A	S	NBR
25	35	6		40114	W	B	S	NBR
25	35	6		72947	W	A	SY	NBR
25	35	6		40553	W	A	O	NBR
25	35	6		43179	W	A	SY	FKM
25	35	6		175578	W	A	S	NBR
25	35	7		20298	W	A		FKM
25	35	7		131049	W	A	S	FKM
25	35	7		130765	W	A		FKM
25	35	7		151425	W	B		NBR
25	35	7		17030	W	A		NBR
25	35	7		19698	W	B	S	NBR
25	35	7		131114	W	A	O	NBR
25	35	7		21966	W	A	S	FKM
25	35	7		17031	W	A	S	NBR
25	35	7		17032	W	B		NBR
25	35	7		179143	W	A	S	NBR
25	35	8		44278	W	B		NBR
25	35	8		62649	W	A		FKM
25	35	8	8.5	165785	W	A	SY	NBR
25	35	8		18881	W	A	S	NBR
25	35	8		17033	W	A		NBR
25	35	8		41244	W	B	O	NBR
25	35	8.5		17034	W	B	S	NBR
25	35	9		18882	W	A		NBR
25	35	10		84507	W	B	S	NBR
25	35	10		17035	W	A		NBR
25	35	10		104241	W	A		FKM



油封

尺寸



油封

尺寸



d1	d2	H	H2	产品编码	产品组	设计型号	形式	材质
25	35	10		18883	W	B		NBR
25	36	6		118690	W	A	SY	NBR
25	36	6		40606	W	A	S	NBR
25	36	7		17036	W	A		NBR
25	36	7		39165	W	A	S	NBR
25	36	7		166531	W	A	OK	NBR
25	36	7		18884	W	B		NBR
25	36	7		62653	W	A		FKM
25	36	8		18885	W	A	S	NBR
25	36	9		18886	W	A	S	NBR
25	36	10		17037	W	A		NBR
25	37	5		156855	W	A	O	NBR
25	37	5		17038	W	A		NBR
25	37	5		56768	W	A		FKM
25	37	5		130839	W	A		FKM
25	37	5.5		40608	W	A	S	NBR
25	37	6		118691	W	A	SY	NBR
25	37	6		179704	W	A	SY	FKM
25	37	6		18887	W	A		NBR
25	37	6		104242	W	A		FKM
25	37	6		18888	W	A	S	NBR
25	37	6		152637	W	A	SY	NBR
25	37	7		130801	W	A		FKM
25	37	7		35080	W	A	S	NBR
25	37	7		18889	W	B		NBR
25	37	7		17039	W	A		NBR
25	37	7		62656	W	A		FKM
25	37	8		18890	W	A		NBR
25	37	8		18891	W	A	S	NBR
25	38	3		41236	W	B	O	NBR
25	38	5		40609	W	A		NBR
25	38	5		39166	W	A	S	NBR
25	38	5		40478	W	A	O	NBR
25	38	6		39167	W	A	S	NBR
25	38	7		130818	W	A		FKM
25	38	7		20299	W	A		FKM
25	38	7		17041	W	A		NBR
25	38	7		17042	W	B		NBR
25	38	7		162922	W	A	S	FKM
25	38	7		40115	W	B	S	NBR
25	38	7		26155	W	A	S	NBR
25	38	8		40610	W	A		NBR
25	38	8		18892	W	A	S	NBR
25	38	9		118035	W	C		NBR
25	38	10		39168	W	A		NBR
25	38	10		39169	W	A	S	NBR
25	38.1	8		62662	W	A		FKM
25	39	7		39179	W	A	S	NBR
25	39	9		18893	W	A		NBR
25	39.5	10		39371	W	A	S	NBR
25	40	4		156525	W	A	O	NBR
25	40	5		18896	W	B		NBR
25	40	5		83167	W	A		FKM
25	40	5		18894	W	A		NBR
25	40	5		18895	W	A	S	NBR

Any seal. Any time.



d1	d2	H	H2	产品编码	产品组	设计型号	形式	材质
25	40	6		34899	W	A	SY	NBR
25	40	6		18679	W	B		NBR
25	40	6		39372	W	A		NBR
25	40	6		18897	W	A	S	NBR
25	40	7		19699	W	B	S	NBR
25	40	7		40611	W	A	O	NBR
25	40	7		44364	W	A	SY	NBR
25	40	7		22500	W	A	S	FKM
25	40	7		17046	W	B		NBR
25	40	7		80764	W	A		FKM
25	40	7		178906	W	B	S	FKM
25	40	7		157213	W	A	SY	FKM
25	40	7		20300	W	A		FKM
25	40	7		17044	W	A		NBR
25	40	7		17045	W	A	S	NBR
25	40	7		117598	W	A		FKM
25	40	8		129982	W	A	SY	NBR
25	40	8		73221	W	A	S	FKM
25	40	8		62671	W	A		FKM
25	40	8		17047	W	A		NBR
25	40	8		19746	W	B	S	NBR
25	40	8		18680	W	B		NBR
25	40	8		18899	W	A	S	NBR
25	40	8		166558	W	B		NBR
25	40	9		39373	W	A	S	NBR
25	40	9		17048	W	C		NBR
25	40	10		20301	W	A		FKM
25	40	10		17051	W	B	S	NBR
25	40	10		17052	W	C		NBR
25	40	10		18901	W	A	S	NBR
25	40	10		17049	W	A		NBR
25	40	10		17050	W	B		NBR
25	40	10		17053	W	C	S	NBR
25	40	10		130867	W	A		FKM
25	40	11		18902	W	A		NBR
25	41	6		18903	W	A	S	NBR
25	41	7		18904	W	A	S	NBR
25	41	8		40682	W	A	S	NBR
25	41.2	6		121228	W	A		FKM
25	41.2	7		40116	W	B	S	NBR
25	41.2	8		39374	W	A	S	NBR
25	41.2	10		130998	W	A	S	NBR
25	41.25	6		39375	W	A	S	NBR
25	41.25	7		40117	W	B	S	NBR
25	41.25	7.3		39376	W	A	S	NBR
25	41.5	6.5		40683	W	A	S	NBR
25	41.55	10		39377	W	A	S	NBR
25	42	5		35206	W	B		FKM
25	42	6		118692	W	A	SY	NBR
25	42	6		17054	W	A		NBR
25	42	6		62680	W	A		FKM
25	42	6		40684	W	A	S	NBR
25	42	6		157214	W	A	SY	FKM
25	42	6.5		18905	W	A		NBR
25	42	7		20774	W	A	S	FKM



油封

尺寸



油封

尺寸



d1	d2	H	H2	产品编码	产品组	设计型号	形式	材质
25	42	7		39378	W	A	S	NBR
25	42	7		38220	W	A		NBR
25	42	7		18906	W	A		NBR
25	42	7		20463	W	A		FKM
25	42	7		130813	W	A		FKM
25	42	7		130991	W	A	S	FKM
25	42	7		18907	W	B		NBR
25	42	7		17056	W	B	S	NBR
25	42	8		17057	W	A		NBR
25	42	8		179315	W	A	S	FKM
25	42	8		17058	W	A	S	NBR
25	42	8		18833	W	B		NBR
25	42	8		62689	W	A	S	FKM
25	42	8		20302	W	A		FKM
25	42	8		166734	W	A	S	NBR
25	42	8.5		62681	W	A		FKM
25	42	8.5		18908	W	A		NBR
25	42	9		75827	W	A		NBR
25	42	9		40363	W	C		NBR
25	42	10		20303	W	A		FKM
25	42	10		19700	W	B	S	NBR
25	42	10		18681	W	B		NBR
25	42	10		18909	W	A	S	NBR
25	42	10		17059	W	A		NBR
25	42	10		17061	W	C	S	NBR
25	42	10		17060	W	C		NBR
25	42.9	9.5		57054	W	A		NBR
25	42.9	9.5		135068	W	B		NBR
25	43	8		40685	W	A	S	NBR
25	43	9		61725	W	C		NBR
25	43	9		62692	W	A		FKM
25	43	9		19787	W	A		NBR
25	43	9		144048	W	A	S	NBR
25	43	10		39379	W	A	S	NBR
25	43	10		48615	W	A		FKM
25	43	10		158680	W	A	S	FKM
25	44	7		61726	W	C		NBR
25	44	7		18911	W	A		NBR
25	44	7		18912	W	A	S	NBR
25	44.5	6		40686	W	A	S	NBR
25	44.5	9		40688	W	A	S	NBR
25	44.5	10		40687	W	A		NBR
25	45	4		40689	W	A	O	NBR
25	45	5		39055	W	B	O	NBR
25	45	7		39380	W	A	S	NBR
25	45	7		18898	W	A		NBR
25	45	7		62505	W	A		FKM
25	45	8		40118	W	B	S	NBR
25	45	8		17062	W	A	S	NBR
25	45	9		18900	W	A	S	NBR
25	45	10		20304	W	A		FKM
25	45	10		19989	W	B	S	NBR
25	45	10		24434	W	B	SY	NBR
25	45	10		17064	W	A	S	NBR
25	45	10		17065	W	C		NBR

Any seal. Any time.



d1	d2	H	H2	产品编码	产品组	设计型号	形式	材质
25	45	10		18910	W	B		NBR
25	45	10		17063	W	A		NBR
25	45	10		62858	W	A	S	FKM
25	45	11		18914	W	A	S	NBR
25	45	11		129983	W	A	SY	NBR
25	45	11		18913	W	A		NBR
25	45	12.5		41423	W	C	S	NBR
25	45	18		40690	W	A	S	NBR
25	46	7		17067	W	A	S	NBR
25	46	7		17066	W	A		NBR
25	46	7		62864	W	A		FKM
25	46	15		40607	W	A	S	NBR
25	46.5	4.8		20659	W	B	O	NBR
25	47	5		40692	W	A	O	NBR
25	47	6		18915	W	A		NBR
25	47	6		127732	W	A	SY	FKM
25	47	6		18916	W	A	S	NBR
25	47	6		84958	W	A	SY	NBR
25	47	6		40693	W	A	O	NBR
25	47	7		17068	W	A		NBR
25	47	7		62872	W	A	S	FKM
25	47	7		131068	W	A	S	FKM
25	47	7		130779	W	A		FKM
25	47	7		180995	W	B	S	NBR
25	47	7		17069	W	A	S	NBR
25	47	7		17070	W	B		NBR
25	47	7		19701	W	B	S	NBR
25	47	7		34930	W	A		FKM
25	47	8		17071	W	A		NBR
25	47	8		17072	W	A	S	NBR
25	47	8		18917	W	B		NBR
25	47	8		20305	W	A		FKM
25	47	9		17073	W	C		NBR
25	47	10		17077	W	B	S	NBR
25	47	10		17078	W	C		NBR
25	47	10		17074	W	A		NBR
25	47	10		17075	W	A	S	NBR
25	47	10		17076	W	B		NBR
25	47	10		19702	W	C	S	NBR
25	47	10		20306	W	A		FKM
25	47	10		148477	W	A		FKM
25	48	7		39381	W	A	S	NBR
25	48	8		17079	W	A		NBR
25	48	8		18918	W	A	S	NBR
25	48	10		18919	W	A	S	NBR
25	48.5	7		39382	W	A	S	NBR
25	50	7		56769	W	A		FKM
25	50	7		62885	W	A		NBR
25	50	8		39383	W	A	S	NBR
25	50	10		18920	W	A	S	NBR
25	50	10		17081	W	C		NBR
25	50	10		20307	W	A		FKM
25	50	10		17080	W	A		NBR
25	50	12		18921	W	A		NBR
25	50	12		38736	W	C		NBR



油封

尺寸



油封

尺寸



d1	d2	H	H2	产品编码	产品组	设计型号	形式	材质
25	50	12		38648	W	B		NBR
25	50	12		104243	W	A		FKM
25	51	11		62912	W	A		FKM
25	51	11		17082	W	A		NBR
25	52	5		43762	W	A		NBR
25	52	6.4		18922	W	A		NBR
25	52	7		117953	W	A		FKM
25	52	7		130983	W	A	S	FKM
25	52	7		56770	W	A	S	FKM
25	52	7		17083	W	A		NBR
25	52	7		18498	W	B	S	NBR
25	52	7		174699	W	A		NBR
25	52	7		56152	W	A	SY	NBR
25	52	7		22562	W	A		FKM
25	52	7		17084	W	A	S	NBR
25	52	7		17085	W	B		NBR
25	52	8		17086	W	A		NBR
25	52	8		18923	W	A	S	NBR
25	52	8		17087	W	B		NBR
25	52	8		62917	W	A		FKM
25	52	9		17088	W	C		NBR
25	52	10		17090	W	B		NBR
25	52	10		17091	W	C		NBR
25	52	10		17092	W	C	S	NBR
25	52	10		20308	W	A		FKM
25	52	10		18924	W	A	S	NBR
25	52	10		19704	W	B	S	NBR
25	52	10		17089	W	A		NBR
25	52	12		18925	W	A	S	NBR
25	52	12		62918	W	A		FKM
25	52	12		17094	W	B		NBR
25	52	12		17095	W	C		NBR
25	52	12		17093	W	A		NBR
25	52	15		39385	W	A		NBR
25	52	15		18926	W	A	S	NBR
25	54	7		70355	W	A		NBR
25	55	9		18927	W	A	S	NBR
25	55	10		18928	W	A	S	NBR
25	55	10		20370	W	A		FKM
25	55	10		35579	W	A		NBR
25	55	11		39384	W	A	S	NBR
25	58	10		66361	W	A		NBR
25	58	10		162247	W	A	S	FKM
25	60	7		40694	W	A		NBR
25	62	5		130795	W	A		NBR
25	62	7		39386	W	A	S	NBR
25	62	7		35715	W	B		NBR
25	62	7		18929	W	A		NBR
25	62	7		82368	W	A	S	FKM
25	62	7		73222	W	A		FKM
25	62	8		17096	W	A		NBR
25	62	8		18930	W	A	S	NBR
25	62	8		63214	W	A		FKM
25	62	10		20309	W	A		FKM
25	62	10		17099	W	C		NBR

Any seal. Any time.



d1	d2	H	H2	产品编码	产品组	设计型号	形式	材质
25	62	10		17097	W	A		NBR
25	62	10		17098	W	B		NBR
25	62	10		38121	W	A	S	NBR
25	62	12		17100	W	C		NBR
25	62	12		18931	W	B		NBR
25	65	12		39387	W	A	S	NBR
25	65	14		39388	W	A	S	NBR
25	70	7		170574	W	A		NBR
25	70	12		74587	W	A	S	NBR
25	72	7		39389	W	A		NBR
25	72	7		85351	W	A		FKM
25	72	7		127004	W	A		FKM
25.1	31.75	3		162215	W	B	O	NBR
25.3	35	5		41361	W	B		NBR
25.4	31.75	3		166676	W	B	O	NBR
25.4	31.75	3.17		60058	W	B		NBR
25.4	31.75	3.17		57055	W	B	O	NBR
25.4	31.75	3.97		166095	W	A	O	NBR
25.4	34.92	4.76		20798	W	A		NBR
25.4	36.51	4.76		75386	W	B		NBR
25.4	36.51	6.35		59771	W	A	S	NBR
25.4	36.51	6.35		19899	W	A		NBR
25.4	36.51	6.5		40691	W	A	S	NBR
25.4	38	3.2		41245	W	B	O	NBR
25.4	38.1	6.35		44766	W	A	S	NBR
25.4	38.1	6.35		163107	W	A	SY	NBR
25.4	38.1	6.35		19906	W	A		NBR
25.4	38.1	6.35		34956	W	B		NBR
25.4	38.1	6.35		60635	W	B	S	NBR
25.4	38.1	7.93		56901	W	A	S	NBR
25.4	38.1	7.93		20028	W	A		NBR
25.4	38.1	9.52		59772	W	A	S	NBR
25.4	38.1	9.52		20029	W	A		NBR
25.4	38.1	9.52		60636	W	B	S	NBR
25.4	38.1	9.52		46854	W	A	S	FKM
25.4	38.1	9.52		144049	W	A		FKM
25.4	38.1	9.52		60060	W	B		NBR
25.4	39.68	4.76		144100	W	B	O	NBR
25.4	39.69	7.93		20801	W	A		NBR
25.4	41	5		81358	W	A		NBR
25.4	41.27	6.35		59773	W	A	S	NBR
25.4	41.27	6.35		20030	W	A		NBR
25.4	41.27	6.35		60061	W	B		NBR
25.4	41.27	7.5		40119	W	B	S	NBR
25.4	41.27	7.93		20031	W	A		NBR
25.4	41.27	7.93		83168	W	A		FKM
25.4	41.27	7.93		39883	W	A	S	NBR
25.4	41.27	9.52		20032	W	A		NBR
25.4	41.27	9.52		60062	W	B		NBR
25.4	41.27	11.11		60832	W	C		NBR
25.4	42.2	7.93		40120	W	B	S	NBR
25.4	42.86	6.35		60063	W	B		NBR
25.4	42.86	6.35		75024	W	B	S	NBR
25.4	44.45	5.16		78520	W	A		FKM
25.4	44.45	5.95		37597	W	A		NBR



油封

尺寸



油封

尺寸



d1	d2	H	H2	产品编码	产品组	设计型号	形式	材质
25.4	44.45	6.35		19911	W	A		NBR
25.4	44.45	6.35		60637	W	B	S	NBR
25.4	44.45	6.35		45063	W	A	S	NBR
25.4	44.45	6.76		157077	W	A	S	FKM
25.4	44.45	7.16		175597	W	A	SY	NBR
25.4	44.45	9.52		59774	W	A	S	NBR
25.4	44.45	9.52		45081	W	A		FKM
25.4	44.45	9.52		60064	W	B		NBR
25.4	44.45	9.52		60833	W	C		NBR
25.4	44.45	9.52		19912	W	A		NBR
25.4	44.45	9.52		83192	W	A	S	FKM
25.4	45.24	11.91		60754	W	B	O	NBR
25.4	46.04	9.52		19916	W	A		NBR
25.4	46.43	11		61828	W	A		NBR
25.4	47.62	6.35		20809	W	A		NBR
25.4	47.62	9.52		20033	W	A		NBR
25.4	47.62	9.52		59775	W	A	S	NBR
25.4	50.38	7.93		60638	W	B	S	NBR
25.4	50.8	6.35		41360	W	B		NBR
25.4	50.8	6.35		59776	W	A	S	NBR
25.4	50.8	6.35		20034	W	A		NBR
25.4	50.8	6.35		60639	W	B	S	NBR
25.4	50.8	9.52		60640	W	B	S	NBR
25.4	50.8	9.52		59777	W	A	S	NBR
25.4	50.8	9.52		19921	W	A		NBR
25.4	50.8	9.52		60065	W	B		NBR
25.4	50.8	12.7		19922	W	A		NBR
25.4	50.8	12.7		60066	W	B		NBR
25.4	50.8	12.7		59778	W	A	S	NBR
25.4	52.38	6.35		60067	W	B		NBR
25.4	52.38	9.52		20035	W	A		NBR
25.4	53.97	9.52		20036	W	A		NBR
25.4	57.15	9.52		20037	W	A		NBR
25.4	62	9.52		37875	W	A	S	NBR
25.5	47.5	7.5		41362	W	B		NBR
26	31	3		72780	W	B	O	NBR
26	34	4		22076	W	A	OK	NBR
26	34	4		73957	W	A		FKM
26	35	5		41246	W	B	O	NBR
26	35	5		130788	W	A		NBR
26	35	7		62650	W	A		FKM
26	35	7		17101	W	A		NBR
26	35	7		17102	W	B		NBR
26	36	3		41247	W	B	O	NBR
26	36	7		18932	W	A	S	NBR
26	36	7		38437	W	A		NBR
26	36	7		56771	W	A		FKM
26	36	8		41363	W	B		NBR
26	36	10		62894	W	A	S	NBR
26	37	7		39719	W	A		FKM
26	37	7		175598	W	A	SY	NBR
26	37	7		62506	W	A	S	FKM
26	37	7		17104	W	A		NBR
26	37	7		18933	W	B		NBR
26	37	7		35470	W	A	S	NBR

Any seal. Any time.



d1	d2	H	H2	产品编码	产品组	设计型号	形式	材质
26	37	10		18934	W	A		NBR
26	37	10		62893	W	A	S	NBR
26	37	10		62640	W	A		FKM
26	38	5		18935	W	A		NBR
26	38	5		18936	W	A	S	NBR
26	38	7		18937	W	A		NBR
26	38	7		18938	W	A	S	NBR
26	38	8		18939	W	A	S	NBR
26	40	5		18940	W	A	S	NBR
26	40	6		39390	W	A	S	NBR
26	40	6		18941	W	A		NBR
26	40	6		157215	W	A	SY	FKM
26	40	7		18943	W	B		NBR
26	40	7		40121	W	B	S	NBR
26	40	7		104244	W	A		FKM
26	40	7		39391	W	A	S	NBR
26	40	7		18942	W	A		NBR
26	40	9		39392	W	A		NBR
26	40	9		39393	W	A	S	NBR
26	42	6		17105	W	A		NBR
26	42	6		62682	W	A		FKM
26	42	7		75250	W	B		NBR
26	42	7		18944	W	A		NBR
26	42	7		22501	W	A	S	FKM
26	42	7		39394	W	A	S	NBR
26	42	7		62507	W	A		FKM
26	42	8		18946	W	A	S	NBR
26	42	8		18945	W	A		NBR
26	42	8		144518	W	A	SY	FKM
26	42	8		129984	W	A	SY	NBR
26	42	9		40364	W	C		NBR
26	42	10		18697	W	B		NBR
26	42	10		18947	W	A	S	NBR
26	42	10		17106	W	C		NBR
26	42	10		39395	W	A		NBR
26	42.7	10		19718	W	A		NBR
26	43	8		18948	W	A	S	NBR
26	45	6		18949	W	A	S	NBR
26	45	7		18950	W	A		NBR
26	45	9		18951	W	A	S	NBR
26	45	10		18952	W	B		NBR
26	45	10		153082	W	B		NBR
26	45	10		40122	W	B	S	NBR
26	46	8		39396	W	A	S	NBR
26	47	5		18953	W	A		NBR
26	47	7		17107	W	A		NBR
26	47	7		20310	W	A		FKM
26	47	7		18954	W	A	S	NBR
26	47	9		38735	W	C		NBR
26	47	9		18955	W	A	S	NBR
26	47	10		18691	W	A		NBR
26	47	10		19747	W	C		NBR
26	47	10		39397	W	A	S	NBR
26	47	10		104245	W	A		FKM
26	48	7		39398	W	A	S	NBR



油封

尺寸



油封

尺寸



d1	d2	H	H2	产品编码	产品组	设计型号	形式	材质
26	48.5	11		40695	W	A		NBR
26	50	10		62965	W	A		NBR
26	50	12		48726	W	C		NBR
26	52	7		18957	W	A	S	NBR
26	52	7.8		39192	W	A	S	NBR
26	52	8		17109	W	B		NBR
26	52	8		18958	W	A	S	NBR
26	52	8		17108	W	A		NBR
26	52	8		104246	W	A		FKM
26	52	9		18959	W	A	S	NBR
26	52	10		38467	W	A	S	NBR
26	52	10		56772	W	A	S	FKM
26	52	10		17110	W	A		NBR
26	62	9		39399	W	A	S	NBR
26	72	10		75132	W	A	S	NBR
26.04	42.86	6		175599	W	A	SY	NBR
26.04	42.86	7.14		60068	W	B		NBR
26.5	47	7		83443	W	A		NBR
26.92	41.15	7.87		62675	W	A		FKM
26.98	38.1	6.35		20800	W	A		NBR
26.98	38.1	6.35		44747	W	A	S	FKM
26.98	38.1	6.35		44746	W	A		FKM
26.98	41.27	7.93		19909	W	A		NBR
26.98	41.27	9.52		60069	W	B		NBR
26.98	44.45	9.52		20038	W	A		NBR
26.98	47.62	9.52		59676	W	A		NBR
26.98	47.62	9.52		83169	W	A		FKM
26.98	50.8	6.35		60070	W	B		NBR
26.98	55.56	7.93		59677	W	A		NBR
27	32	3		115803	W	B	O	NBR
27	33	3		41248	W	B	O	NBR
27	33.7	4		40697	W	A	O	NBR
27	34	3		55931	W	B	O	NBR
27	35	4		17111	W	A		NBR
27	35	4		62651	W	A		FKM
27	35	7		17112	W	A		NBR
27	35	7		62652	W	A		FKM
27	35	7.5		27479	W	A		NBR
27	35.5	5		40696	W	A	O	NBR
27	36	4		40699	W	A	O	NBR
27	36	6		39400	W	A	S	NBR
27	37	5		40700	W	A	OK	NBR
27	37	5		41387	W	B	S	NBR
27	37	7		69420	W	A	S	NBR
27	37	7		124959	W	B		NBR
27	37	7		22563	W	A		FKM
27	37	7		17113	W	A		NBR
27	38	6		17114	W	A		NBR
27	38	7		69710	W	A		NBR
27	38	7		40701	W	A	S	NBR
27	40	3		40479	W	A	O	NBR
27	40	6		18960	W	A		NBR
27	40	6		39401	W	A	S	NBR
27	40	7		39200	W	A		NBR
27	40	7		39402	W	A	S	NBR

Any seal. Any time.



d1	d2	H	H2	产品编码	产品组	设计型号	形式	材质
27	40	8		18961	W	A	S	NBR
27	40	10		56918	W	A		NBR
27	41	10		17116	W	A		NBR
27	41	10		27548	W	A		FKM
27	41.2	8		40702	W	A		NBR
27	41.2	9.5		40703	W	A		NBR
27	41.5	9		40704	W	A	S	NBR
27	42	7		62683	W	A		FKM
27	42	7		157295	W	A	SY	NBR
27	42	7		17117	W	A		NBR
27	42	7		157243	W	A	SY	FKM
27	42	10		62684	W	A		FKM
27	42	10		62690	W	A	S	FKM
27	42	10		17119	W	A	S	NBR
27	42	10		17118	W	A		NBR
27	42	10		17120	W	B		NBR
27	42.86	8		166096	W	B	SY	NBR
27	43	8		39403	W	A	S	NBR
27	43	9		18962	W	A		NBR
27	43	9		18964	W	B	S	NBR
27	43	9		40705	W	A	O	NBR
27	43	9		40123	W	B		NBR
27	43	9		18963	W	A	S	NBR
27	44	7		80969	W	A	SY	FKM
27	44	7		27343	W	A	SY	NBR
27	45	7		39404	W	A		NBR
27	45	8		18965	W	A	S	NBR
27	45	8		17121	W	A		NBR
27	45	9		39405	W	A	S	NBR
27	47	6		17122	W	A		NBR
27	47	6		104247	W	A		FKM
27	47	8		39406	W	A	S	NBR
27	47	8		62870	W	A		FKM
27	47	8		17123	W	A		NBR
27	47	9.8		62871	W	A		FKM
27	47	9.8		19795	W	A		NBR
27	47	10		20311	W	A		FKM
27	47	10		17124	W	A		NBR
27	47	10		40365	W	C		NBR
27	47	11		129985	W	A	SY	NBR
27	47	11		18966	W	A	S	NBR
27	50	10		60218	W	A	S	NBR
27	50	10		18967	W	A		NBR
27	50	10		104248	W	A		FKM
27	51	10		83465	W	A	S	NBR
27	52	8		62919	W	A		FKM
27	52	8		17125	W	A		NBR
27	52	8		17126	W	B		NBR
27	53	7		131105	W	A	O	NBR
27	53	7		130638	W	A		NBR
27	55	8		35718	W	A	S	NBR
27	75	12		18968	W	A	S	NBR
27.2	41.3	6.7		57056	W	B		NBR
27.8	38	7		74986	W	A		NBR
28	33	6		40480	W	A	O	NBR



油封

尺寸



油封

尺寸



d1	d2	H	H2	产品编码	产品组	设计型号	形式	材质
28	33.3	3.5		41249	W	B	O	NBR
28	34	4		40706	W	A	OK	NBR
28	35	4		22077	W	A	OK	NBR
28	35	4		41250	W	B	O	NBR
28	35	4		34474	W	A	O	FKM
28	35	5		38886	W	A	S	NBR
28	35	5		45084	W	B	S	NBR
28	35	5		117567	W	A		NBR
28	35	5		41251	W	B	O	NBR
28	35	7		38887	W	A	S	NBR
28	35	7		40707	W	A	O	NBR
28	36	5		41252	W	B	O	NBR
28	36	5		68265	W	A	O	NBR
28	37	4		22078	W	A	OK	NBR
28	37	4		110712	W	B	O	NBR
28	37	5		38888	W	A	S	NBR
28	37	6		38891	W	A	S	NBR
28	37	8		40698	W	A		NBR
28	38	5		40712	W	A		NBR
28	38	5.5		18969	W	A		NBR
28	38	5.5		174914	W	A	S	NBR
28	38	5.5		104249	W	A		FKM
28	38	6		17127	W	A		NBR
28	38	6		62661	W	A		FKM
28	38	7		62508	W	A	S	FKM
28	38	7		40713	W	A	O	NBR
28	38	7		22564	W	A		FKM
28	38	7		17129	W	A	S	NBR
28	38	7		17130	W	B		NBR
28	38	7		17128	W	A		NBR
28	38	8		18970	W	A		NBR
28	38	8		18971	W	A	S	NBR
28	38	10		38892	W	A	S	NBR
28	39	7		40124	W	B		NBR
28	40	5		40481	W	A	O	NBR
28	40	5		38893	W	A	S	NBR
28	40	5		17131	W	A		NBR
28	40	5		62672	W	A		FKM
28	40	6		34896	W	A	SY	NBR
28	40	6		133400	W	A	SY	FKM
28	40	7		157276	W	A	SY	NBR
28	40	7		62945	W	A		NBR
28	40	7		17132	W	A		NBR
28	40	7		20312	W	A		FKM
28	40	7		118732	W	A		NBR
28	40	7		38649	W	B		NBR
28	40	7		157244	W	A	SY	FKM
28	40	7		134897	W	A	S	FKM
28	40	7		118735	W	A		FKM
28	40	7		37886	W	A	S	NBR
28	40	8		17133	W	A		NBR
28	40	8		104250	W	A		FKM
28	40	8		40125	W	B		NBR
28	40	8		18973	W	A	S	NBR
28	40	8		118693	W	A	SY	NBR

Any seal. Any time.



d1	d2	H	H2	产品编码	产品组	设计型号	形式	材质
28	40	8		18974	W	B	S	NBR
28	40	8		157216	W	A	SY	FKM
28	40	9		118694	W	A	SY	NBR
28	40	9		68264	W	A		NBR
28	40	10		38894	W	A	S	NBR
28	40	10		20742	W	A		FKM
28	40	10		44279	W	B		NBR
28	40	10		17134	W	A		NBR
28	40	10		17135	W	C		NBR
28	41.2	8		40708	W	A	S	NBR
28	41.5	9		40709	W	A	S	NBR
28	42	6		40710	W	A	S	NBR
28	42	7		62685	W	A		FKM
28	42	7		17136	W	A		NBR
28	42	7		18975	W	A	S	NBR
28	42	8		18976	W	A	S	NBR
28	42	8		17137	W	A		NBR
28	42	8		104251	W	A		FKM
28	42	10		18692	W	A		NBR
28	42	10		56774	W	A		FKM
28	42	11		38895	W	A	S	NBR
28	42.5	8		18972	W	A		NBR
28	42.5	8		38896	W	A	S	NBR
28	42.9	9.5		38897	W	A		NBR
28	43	6.5		40126	W	B	S	NBR
28	43	7		38898	W	A		NBR
28	43	8		38899	W	A	S	NBR
28	43	9		19788	W	A		NBR
28	43	9		62693	W	A		FKM
28	43	10		38900	W	A	S	NBR
28	43	10		17138	W	A		NBR
28	43	10		17139	W	B		NBR
28	43	10		62852	W	A		FKM
28	44	7		18977	W	A	S	NBR
28	44	7		40127	W	B	S	NBR
28	44	8		18978	W	B	S	NBR
28	44	10		19790	W	A		NBR
28	44	10		62854	W	A		FKM
28	45	5		38901	W	A	S	NBR
28	45	5		38902	W	A		NBR
28	45	6		38903	W	A	S	NBR
28	45	6		18979	W	A		NBR
28	45	7		38904	W	A	S	NBR
28	45	7		56775	W	A		FKM
28	45	7		64399	W	A		NBR
28	45	8		17140	W	A		NBR
28	45	8		17141	W	B		NBR
28	45	8		38203	W	A	S	NBR
28	45	8		20313	W	A		FKM
28	45	9		17142	W	A		NBR
28	45	9		20314	W	A		FKM
28	45	10		17143	W	A	S	NBR
28	45	10		17144	W	B		NBR
28	45.2	8		40711	W	A	S	NBR
28	47	5		38905	W	A		NBR



油封

尺寸



油封

尺寸



d1	d2	H	H2	产品编码	产品组	设计型号	形式	材质
28	47	7		56776	W	A	S	FKM
28	47	7		17146	W	A	S	NBR
28	47	7		36911	W	A		FKM
28	47	7		17145	W	A		NBR
28	47	7		36625	W	B		NBR
28	47	7		56182	W	A		NBR
28	47	7		169840	W	A	S	FKM
28	47	8		17147	W	B		NBR
28	47	8		18981	W	A	S	NBR
28	47	8		24720	W	C		NBR
28	47	8		104252	W	A		FKM
28	47	8		18980	W	A		NBR
28	47	9		40366	W	C		NBR
28	47	10		22161	W	A	S	FKM
28	47	10		34886	W	C		NBR
28	47	10		18499	W	B	S	NBR
28	47	10		38906	W	A	S	NBR
28	47	10		20315	W	A		FKM
28	47	10		18682	W	B		NBR
28	47	10		17148	W	A		NBR
28	48	5		26392	W	A		NBR
28	48	8		24266	W	B		NBR
28	48	8		18982	W	A	S	NBR
28	48	10		60202	W	A		NBR
28	48	11		18983	W	A		NBR
28	48	11		18985	W	B	S	NBR
28	48	11		18984	W	A	S	NBR
28	48	11		129986	W	A	SY	NBR
28	50	6		38907	W	A	S	NBR
28	50	8		18986	W	A		NBR
28	50	8		104253	W	A		FKM
28	50	10		38909	W	A		NBR
28	50	10		60203	W	C		NBR
28	50	10		38908	W	A	S	NBR
28	50	10		20382	W	A		FKM
28	50	11		40714	W	A	S	NBR
28	50	12		68334	W	A		NBR
28	50	12		82086	W	B		NBR
28	50.8	10		57058	W	A	S	NBR
28	52	5		38910	W	A		NBR
28	52	6		18987	W	A	S	NBR
28	52	7		18988	W	A		NBR
28	52	7		82174	W	B		NBR
28	52	7		21073	W	A		FKM
28	52	7		18989	W	A	S	NBR
28	52	7		22502	W	A	S	FKM
28	52	9		40367	W	C		NBR
28	52	10		17151	W	A		NBR
28	52	10		38911	W	A	S	NBR
28	52	10		62920	W	A		FKM
28	52	12		62921	W	A		FKM
28	52	12		17152	W	A		NBR
28	52	12		159367	W	B		NBR
28	52.4	12.5		19807	W	A		NBR
28	55	10		40715	W	A		NBR

Any seal. Any time.



d1	d2	H	H2	产品编码	产品组	设计型号	形式	材质
28	57	12		83444	W	A		NBR
28	58	7		60204	W	B		NBR
28	58	8		176089	W	A	S	NBR
28	62	10		104254	W	A		FKM
28	62	10		18990	W	A		NBR
28	62	12		19852	W	A		NBR
28	62	12		63215	W	A		FKM
28.2	35	3.3		41253	W	B	O	NBR
28.5	36	8		41390	W	B	S	NBR
28.5	44.53	10		57059	W	A	S	NBR
28.56	35	2.2		162211	W	B	O	NBR
28.56	35	4		162206	W	B	O	NBR
28.56	35	4		162205	W	B	O	NBR
28.57	34.92	3.17		81153	W	B	O	NBR
28.57	35	2.2		84024	W	B	O	NBR
28.57	35.1	4		79604	W	B	O	NBR
28.57	38.1	4.76		60755	W	B	O	NBR
28.57	38.1	6.35		19907	W	A		NBR
28.57	39.69	6.35		57060	W	A		NBR
28.57	39.69	9.52		21668	W	A		NBR
28.57	41.27	6.35		60641	W	B	S	NBR
28.57	41.27	6.35		60071	W	B		NBR
28.57	41.27	6.35		19910	W	A		NBR
28.57	41.27	7.93		60642	W	B	S	NBR
28.57	41.27	7.93		59779	W	A	S	NBR
28.57	41.27	7.93		20039	W	A		NBR
28.57	41.27	9.52		20040	W	A		NBR
28.57	41.27	9.52		21145	W	A		FKM
28.57	41.27	9.52		38468	W	A	S	NBR
28.57	41.27	12.7		60756	W	B	O	NBR
28.57	42.86	6.35		34924	W	A	S	NBR
28.57	42.86	7.93		35744	W	A	S	NBR
28.57	44.45	5.33		95606	W	A		NBR
28.57	44.45	6.35		60072	W	B		NBR
28.57	44.45	7.93		20041	W	A		NBR
28.57	44.45	7.93		60073	W	B		NBR
28.57	44.45	9.52		59780	W	A	S	NBR
28.57	44.45	9.52		20042	W	A		NBR
28.57	44.45	11.11		19913	W	A		NBR
28.57	45.24	6.35		38095	W	A	S	NBR
28.57	46.43	6.35		60643	W	B	S	NBR
28.57	47.62	6.35		60644	W	B	S	NBR
28.57	47.62	6.35		60074	W	B		NBR
28.57	47.62	6.35		19917	W	A		NBR
28.57	47.62	7.13		41389	W	B	S	NBR
28.57	47.62	9.52		59781	W	A	S	NBR
28.57	47.62	9.52		19918	W	A		NBR
28.57	47.62	9.52		60075	W	B		NBR
28.57	47.62	11.11		60834	W	C		NBR
28.57	50.8	6.35		44814	W	A	S	NBR
28.57	50.8	6.35		165191	W	A	SY	NBR
28.57	50.8	9.52		59782	W	A	S	NBR
28.57	50.8	9.52		20043	W	A		NBR
28.57	50.8	11.11		20044	W	A		NBR
28.57	50.8	11.11		21144	W	A		FKM



油封

尺寸



油封

尺寸



d1	d2	H	H2	产品编码	产品组	设计型号	形式	材质
28.57	50.8	12.7		19923	W	A		NBR
28.57	50.8	12.7		60076	W	B		NBR
28.57	50.8	12.7		60645	W	B	S	NBR
28.57	50.8	12.7		38292	W	A		FKM
28.57	52.38	9.52		20045	W	A		NBR
28.57	53.97	9.52		20046	W	A		NBR
28.57	57.15	9.52		20047	W	A		NBR
28.57	57.4	9.52		60207	W	A		NBR
28.57	61.91	11.11		59783	W	A	S	NBR
28.6	39.65	4.75		62663	W	A		FKM
28.6	40	8		38912	W	A	S	NBR
28.6	40	8		40452	W	C	S	NBR
28.6	43	6.5		57061	W	B	S	NBR
28.8	46.5	11.2		57062	W	A	S	NBR
29	35	3.5		40716	W	A	O	NBR
29	35	4		176949	W	A	OK	NBR
29	37	6		41254	W	B	O	NBR
29	38	4		22079	W	A	OK	NBR
29	38	6		40717	W	A		NBR
29	39	4		40718	W	A	O	NBR
29	39	5		18991	W	A		NBR
29	40	5		156232	W	B	O	NBR
29	40	7		17153	W	B		NBR
29	40	7		83445	W	A		NBR
29	40	7		19705	W	A	S	NBR
29	40	8		65444	W	A	S	NBR
29	40.5	4		40719	W	A	O	NBR
29	41	5		18992	W	A		NBR
29	41	6		18993	W	A		NBR
29	41	7		161549	W	B	S	NBR
29	42	7		62686	W	A		FKM
29	42	7		17154	W	A		NBR
29	42.9	9.5		19786	W	B		NBR
29	43	7		179183	W	A	S	NBR
29	43	7		38913	W	A		NBR
29	43	8		41424	W	C	S	NBR
29	45	7		18994	W	A		NBR
29	45	8		38914	W	A	S	NBR
29	45	8		17155	W	A		NBR
29	45	8		62859	W	A		FKM
29	45	9		18956	W	A	S	NBR
29	45	9		38915	W	A		NBR
29	45	9.5		19791	W	A		NBR
29	45	9.5		19792	W	B		NBR
29	45	9.5		62860	W	A		FKM
29	45	10		17156	W	B		NBR
29	45	12		81359	W	A	S	NBR
29	46	10		38916	W	A		NBR
29	47	10		62873	W	A		FKM
29	47	10		17157	W	A		NBR
29	47	11		172423	W	A		NBR
29	48	10		17158	W	A		NBR
29	50	10		62902	W	A		FKM
29	50	10		17159	W	A		NBR
29	50	12		26393	W	A		NBR

Any seal. Any time.



d1	d2	H	H2	产品编码	产品组	设计型号	形式	材质
29	52	7		156450	W	A	S	NBR
29	52	9		17160	W	A		NBR
29	52	9		62922	W	A		FKM
29	55	9		17161	W	A		NBR
29	55	9		63180	W	A		FKM
29	62	10		17162	W	A		NBR
29	62	10		63216	W	A		FKM
29.36	38.1	4.76		134033	W	A	S	FKM
29.36	42.82	7.93		134030	W	A	S	FKM
29.44	55.68	6.35		60077	W	B		NBR
29.5	37	4		150143	W	B	O	NBR
29.8	47	9.9		179141	W	A	S	NBR
30	34	3		61616	W	B	O	FKM
30	35	3		41255	W	B	O	NBR
30	36	5		36387	W	A		NBR
30	37	3		72895	W	B	O	NBR
30	37	3.2		93287	W	A	OK	NBR
30	37	4		40482	W	B	O	NBR
30	37	4		36154	W	A		NBR
30	37	4		180978	W	A	OK	NBR
30	37	4		84094	W	A	OK	FKM
30	37	4		22080	W	A	OK	NBR
30	37	4		173094	W	B		NBR
30	37	4.5		41256	W	B	O	NBR
30	37	8		40483	W	A	O	NBR
30	38	5		65004	W	B		NBR
30	39	7		41364	W	B		NBR
30	39	7		41257	W	B	O	NBR
30	40	4		45783	W	A	OK	FKM
30	40	4		48932	W	B	O	NBR
30	40	4		56784	W	A	OK	NBR
30	40	5		40720	W	A	O	NBR
30	40	5		73223	W	A		FKM
30	40	5		18995	W	A		NBR
30	40	5		18996	W	A	S	NBR
30	40	5		126224	W	A	SY	NBR
30	40	5		41258	W	B	O	NBR
30	40	6		40484	W	B	O	NBR
30	40	7		17164	W	A	S	NBR
30	40	7		17165	W	B		NBR
30	40	7		131074	W	A	S	FKM
30	40	7		131115	W	A	O	NBR
30	40	7		149520	W	A	SY	NBR
30	40	7		44792	W	A	S	FKM
30	40	7		130814	W	A		FKM
30	40	7		157245	W	A	SY	FKM
30	40	7		20316	W	A		FKM
30	40	7		17163	W	A		NBR
30	40	8		69329	W	A	S	NBR
30	40	8		104256	W	A		FKM
30	40	8		38917	W	A		NBR
30	40	9		24206	W	A		NBR
30	40	9		104255	W	A		FKM
30	40	10		62673	W	A		FKM
30	40	10		17166	W	A		NBR



油封

尺寸



油封

尺寸



d1	d2	H	H2	产品编码	产品组	设计型号	形式	材质
30	40	10		60208	W	B		FKM
30	41	6.3		40721	W	A		NBR
30	41	7		38918	W	A	S	NBR
30	42	4.5		18997	W	A		NBR
30	42	4.6		35207	W	B		FKM
30	42	5		40722	W	A	O	NBR
30	42	5		41259	W	B	O	NBR
30	42	5		38919	W	A	S	NBR
30	42	5.7		38366	W	A		NBR
30	42	6		72723	W	A	S	FKM
30	42	6		26542	W	A	S	NBR
30	42	6		104257	W	A		FKM
30	42	6		88172	W	A	SY	FKM
30	42	6		46488	W	A	SY	NBR
30	42	6		18998	W	A		NBR
30	42	6.5		38920	W	A	S	NBR
30	42	7		34849	W	A	S	NBR
30	42	7		17167	W	A		NBR
30	42	7		130819	W	A		FKM
30	42	7		22503	W	A	S	FKM
30	42	7		126225	W	A	SY	NBR
30	42	7		20317	W	A		FKM
30	42	7		18999	W	B	S	NBR
30	42	7		17168	W	B		NBR
30	42	7.9		38921	W	A	S	NBR
30	42	8		19000	W	A		NBR
30	42	8		19001	W	A	S	NBR
30	42	8		62691	W	A	S	FKM
30	42	8		41368	W	B		NBR
30	42	8		104258	W	A		FKM
30	42	10		19002	W	A	S	NBR
30	42	10		26154	W	A		NBR
30	42	10		20386	W	A		FKM
30	42	12		26394	W	A		NBR
30	42	12		40723	W	A	S	NBR
30	42.5	6		124788	W	A		FKM
30	43	8		38922	W	A	S	NBR
30	43	8		104259	W	A		FKM
30	43	8		175245	W	A	SY	NBR
30	43	8		17169	W	B		NBR
30	43	8		19003	W	A		NBR
30	43	8		44360	W	C	S	NBR
30	43	8.5		19004	W	A	S	NBR
30	43	10		41369	W	B		NBR
30	43	10		38923	W	A	S	NBR
30	43.5	10		64978	W	B	S	NBR
30	43.6	9		40128	W	B		NBR
30	43.7	9.5		57063	W	B	S	NBR
30	44	7		19005	W	A	S	NBR
30	44	7		61727	W	B	S	NBR
30	44	7		26395	W	A		NBR
30	44	8		38924	W	A		NBR
30	44	9		19006	W	A	S	NBR
30	44	9		40129	W	B	S	NBR
30	44	10		62855	W	A		FKM

Any seal. Any time.



d1	d2	H	H2	产品编码	产品组	设计型号	形式	材质
30	44	10		17170	W	A		NBR
30	45	5		104260	W	A		FKM
30	45	5		19007	W	A		NBR
30	45	5		37435	W	A	S	NBR
30	45	5.5		44857	W	A		NBR
30	45	6		104261	W	A		FKM
30	45	6		26396	W	A		NBR
30	45	6		40256	W	B	S	NBR
30	45	6		41260	W	B	O	NBR
30	45	6		40485	W	A	O	NBR
30	45	7		44660	W	A	SY	NBR
30	45	7		17171	W	A		NBR
30	45	7		17172	W	B		NBR
30	45	7		62509	W	A	S	FKM
30	45	7		38925	W	A	S	NBR
30	45	7		62641	W	A		FKM
30	45	8		17173	W	A		NBR
30	45	8		62861	W	A	S	FKM
30	45	8		17174	W	A	S	NBR
30	45	8		17175	W	B		NBR
30	45	8		22565	W	A		FKM
30	45	9		40724	W	A	S	NBR
30	45	9.5		19707	W	C		NBR
30	45	9.5		19706	W	B		NBR
30	45	10		20464	W	A		FKM
30	45	10		19008	W	A		NBR
30	45	10		17177	W	C	S	NBR
30	45	10		19708	W	B	S	NBR
30	45	10		38926	W	A	S	NBR
30	45	10		17176	W	C		NBR
30	45	11		19009	W	A	S	NBR
30	45.2	10		62863	W	A		FKM
30	45.2	10		19793	W	A		NBR
30	46	5		19010	W	A		NBR
30	46	5		19011	W	A	S	NBR
30	46	7		19012	W	A	S	NBR
30	46	8		38927	W	A	S	NBR
30	46	8		19013	W	A		NBR
30	46	10		17178	W	C		NBR
30	46	10		104262	W	A		FKM
30	46	10		19014	W	A		NBR
30	47	4		84178	W	A		NBR
30	47	5		144301	W	A		FKM
30	47	5		40725	W	A	S	NBR
30	47	5		17179	W	A		NBR
30	47	6		38928	W	A	S	NBR
30	47	6		104263	W	A		FKM
30	47	6		19015	W	A		NBR
30	47	7		20318	W	A		FKM
30	47	7		157246	W	A	SY	FKM
30	47	7		177847	W	B	S	FKM
30	47	7		21967	W	A	S	FKM
30	47	7		19709	W	B	S	NBR
30	47	7		130762	W	A		FKM
30	47	7		80155	W	A	O	NBR



油封

尺寸



油封

尺寸



d1	d2	H	H2	产品编码	产品组	设计型号	形式	材质
30	47	7		17180	W	A		NBR
30	47	7		17181	W	A	S	NBR
30	47	7		17182	W	B		NBR
30	47	7		56181	W	A		NBR
30	47	7		157296	W	A	SY	NBR
30	47	7		178907	W	B	S	FKM
30	47	8		62874	W	A		FKM
30	47	8		17184	W	B	S	NBR
30	47	8		18701	W	A	S	NBR
30	47	8		17183	W	A		NBR
30	47	8		59612	W	B		NBR
30	47	9		25663	W	C		NBR
30	47	10		17187	W	B	S	NBR
30	47	10		17188	W	C		NBR
30	47	10		19016	W	A	S	NBR
30	47	10		20319	W	A		FKM
30	47	10		17185	W	A		NBR
30	47	10		17189	W	C	S	NBR
30	47	10		17186	W	B		NBR
30	48	7		38929	W	A	S	NBR
30	48	8		37438	W	A		FKM
30	48	8		17190	W	A		NBR
30	48	8		19017	W	A	S	NBR
30	48	10		93325	W	B		NBR
30	48	10		38930	W	A	S	NBR
30	48	10		104264	W	A		FKM
30	48	10		17191	W	A		NBR
30	49	7		38931	W	A	S	NBR
30	49	9		17192	W	A		NBR
30	49.5	10		19799	W	A		NBR
30	50	5		158720	W	A	O	NBR
30	50	5		130784	W	A		NBR
30	50	5		40726	W	A	O	NBR
30	50	7		17193	W	B		NBR
30	50	7		157247	W	A	SY	FKM
30	50	7		40368	W	C	S	NBR
30	50	7		45109	W	A	SY	NBR
30	50	7		38438	W	A		NBR
30	50	7		19018	W	A	S	NBR
30	50	7		62510	W	A		FKM
30	50	7		18638	W	B	S	NBR
30	50	8		62903	W	A		FKM
30	50	8		38932	W	A	S	NBR
30	50	8		17194	W	A		NBR
30	50	10		17195	W	A		NBR
30	50	10		17199	W	C	S	NBR
30	50	10		17197	W	B	S	NBR
30	50	10		38933	W	A	S	NBR
30	50	10		20320	W	A		FKM
30	50	10		17196	W	B		NBR
30	50	10		17198	W	C		NBR
30	50	11		19020	W	A	S	NBR
30	50	11		41394	W	B	S	NBR
30	50	11		129987	W	A	SY	NBR
30	50	11		19019	W	A		NBR

Any seal. Any time.



d1	d2	H	H2	产品编码	产品组	设计型号	形式	材质
30	50	12		17201	W	B	S	NBR
30	50	12		17202	W	C		NBR
30	50	12		17203	W	C	S	NBR
30	50	12		38934	W	A		NBR
30	50	12		17200	W	B		NBR
30	50	15		40727	W	A	S	NBR
30	51	6		41365	W	B		NBR
30	51	8		40728	W	A	S	NBR
30	52	4		179073	W	A	S	NBR
30	52	4		6225	W	A	OK	NBR
30	52	4		179071	W	A		NBR
30	52	5		19021	W	A		NBR
30	52	5		73224	W	A		FKM
30	52	6		62923	W	A		FKM
30	52	6		17204	W	A		NBR
30	52	7		17205	W	A		NBR
30	52	7		20321	W	A		FKM
30	52	7		38682	W	B	S	NBR
30	52	7		19022	W	A	S	NBR
30	52	7		159421	W	A		NBR
30	52	7		17206	W	B		NBR
30	52	7		36444	W	A	S	FKM
30	52	7		126358	W	A		FKM
30	52	7		118695	W	A	SY	NBR
30	52	8		62924	W	A		FKM
30	52	8		19023	W	A	S	NBR
30	52	8		17207	W	A		NBR
30	52	8.5		69917	W	A		NBR
30	52	9		130520	W	C		FKM
30	52	9		17208	W	C		NBR
30	52	10		17213	W	C	S	NBR
30	52	10		17209	W	A		NBR
30	52	10		17211	W	B	S	NBR
30	52	10		17212	W	C		NBR
30	52	10		19024	W	A	S	NBR
30	52	10		20322	W	A		FKM
30	52	10		22504	W	A	S	FKM
30	52	10		17210	W	B		NBR
30	52	11		19025	W	A	S	NBR
30	52	12		19026	W	A	S	NBR
30	52	12		17216	W	C		NBR
30	52	12		17217	W	C	S	NBR
30	52	12		62925	W	A		FKM
30	52	12		17214	W	A		NBR
30	52	12		17215	W	B	S	NBR
30	52	12		16990	W	B		NBR
30	53.5	10.13		38935	W	A	S	NBR
30	54	9		144052	W	A	S	NBR
30	54	10		17218	W	A		NBR
30	54	10		179428	W	A	S	NBR
30	54	10		63175	W	A		FKM
30	54	12		40730	W	A	S	NBR
30	55	6		19027	W	A		NBR
30	55	6		38936	W	A	S	NBR
30	55	7		38938	W	A	S	NBR



油封

尺寸



油封

尺寸



d1	d2	H	H2	产品编码	产品组	设计型号	形式	材质
30	55	7		56924	W	A		FKM
30	55	7		130763	W	A		FKM
30	55	7		176608	W	B		FKM
30	55	7		17219	W	A		NBR
30	55	7		17220	W	B	S	NBR
30	55	7		76243	W	A	S	FKM
30	55	7		169670	W	A	S	NBR
30	55	8		38939	W	A	S	NBR
30	55	10		56778	W	A	S	FKM
30	55	10		17224	W	C		NBR
30	55	10		17225	W	C	S	NBR
30	55	10		19028	W	A	S	NBR
30	55	10		17221	W	A		NBR
30	55	10		17222	W	B		NBR
30	55	10		20323	W	A		FKM
30	55	10		17223	W	B	S	NBR
30	55	11		38940	W	A	S	NBR
30	55	12		17228	W	B	S	NBR
30	55	12		19029	W	A	S	NBR
30	55	12		63181	W	A		FKM
30	55	12		17226	W	A		NBR
30	55	12		17227	W	B		NBR
30	55	12		17230	W	C	S	NBR
30	55	12		165399	W	B		NBR
30	55	12		17229	W	C		NBR
30	55	15		41261	W	B	O	NBR
30	56	6		40731	W	A	S	NBR
30	56	6		19748	W	B		NBR
30	56	7		38941	W	A		NBR
30	56	8		104265	W	A		FKM
30	56	8		38942	W	A	S	NBR
30	56	8		19030	W	A		NBR
30	56	10		38943	W	A	S	NBR
30	56	10		17231	W	A		NBR
30	56	10		17232	W	C		NBR
30	56	10		20324	W	A		FKM
30	56	12		17233	W	C		NBR
30	56	12		104266	W	A		FKM
30	56	12		160841	W	A		NBR
30	56	12		44229	W	A		NBR
30	57	8		19849	W	A		NBR
30	57	8		63193	W	A		FKM
30	58.3	9		40729	W	A	S	NBR
30	60	7		69757	W	C		NBR
30	60	10		17236	W	B	S	NBR
30	60	10		63203	W	A		FKM
30	60	10		74030	W	A	S	NBR
30	60	10		17234	W	A		NBR
30	60	10		17235	W	B		NBR
30	60	10		17237	W	C		NBR
30	60	10		17238	W	C	S	NBR
30	60	12		17240	W	B	S	NBR
30	60	12		40732	W	A	S	NBR
30	60	12		17241	W	C		NBR
30	60	12		17242	W	C	S	NBR

Any seal. Any time.



d1	d2	H	H2	产品编码	产品组	设计型号	形式	材质
30	60	12		17239	W	B		NBR
30	62	5		38944	W	A		NBR
30	62	6		40486	W	A	O	NBR
30	62	6		18477	W	B		NBR
30	62	6.5		40733	W	A		NBR
30	62	7		17244	W	A	S	NBR
30	62	7		17245	W	B		NBR
30	62	7		176201	W	A	S	NBR
30	62	7		20325	W	A		FKM
30	62	7		63217	W	A	S	FKM
30	62	7		19710	W	B	S	NBR
30	62	7		130864	W	A		FKM
30	62	7		17243	W	A		NBR
30	62	8		19031	W	A	S	NBR
30	62	8		63218	W	A		FKM
30	62	8		17246	W	A		NBR
30	62	8		64390	W	A	S	FKM
30	62	9		40734	W	A	S	NBR
30	62	9		17247	W	C		NBR
30	62	10		160802	W	A		NBR
30	62	10		177542	W	A		NBR
30	62	10		17248	W	A		NBR
30	62	10		175457	W	C		NBR
30	62	10		38945	W	A	S	NBR
30	62	10		37907	W	B		NBR
30	62	10		17250	W	C		NBR
30	62	10		20326	W	A		FKM
30	62	10		17249	W	B	S	NBR
30	62	10		17251	W	C	S	NBR
30	62	11.5		19032	W	A	S	NBR
30	62	12		34801	W	A	S	NBR
30	62	12		63219	W	A		FKM
30	62	12		17253	W	B	S	NBR
30	62	12		44280	W	B		NBR
30	62	12		17252	W	A		NBR
30	62	12		17254	W	C		NBR
30	62	12		17255	W	C	S	NBR
30	62	13		41370	W	B		NBR
30	65	8		38958	W	A		NBR
30	65	10		104267	W	A		FKM
30	65	10		38959	W	A	S	NBR
30	65	10		19033	W	A		NBR
30	66	12		38960	W	A	S	NBR
30	68	10		176090	W	A	S	NBR
30	70	10		38961	W	A		NBR
30	70	10		38962	W	A	S	NBR
30	72	7		26357	W	B	S	NBR
30	72	8		19034	W	A	S	NBR
30	72	8		56779	W	A	S	FKM
30	72	10		37163	W	A	S	NBR
30	72	10		171620	W	A	S	FKM
30	72	10		17258	W	C		NBR
30	72	10		175455	W	A		NBR
30	72	10		17256	W	A		NBR
30	72	10		17257	W	B	S	NBR



油封

尺寸



油封

尺寸



d1	d2	H	H2	产品编码	产品组	设计型号	形式	材质
30	72	10		62643	W	A		FKM
30	72	10		166057	W	A	S	FKM
30	72	10		20238	W	B		NBR
30	72	12		17261	W	C		NBR
30	72	12		17262	W	C	S	NBR
30	72	12		17260	W	B	S	NBR
30	75	9		57064	W	A	S	NBR
30	75	10		19035	W	A	S	NBR
30	77	9		19036	W	A	S	NBR
30	77	10		19037	W	A	S	NBR
30	80	10		42561	W	A	S	NBR
30.16	41.33	6.35		60024	W	A	O	NBR
30.16	42.86	4.76		37878	W	B		NBR
30.16	42.86	4.76		59678	W	A		NBR
30.16	42.86	7.93		60646	W	B	S	NBR
30.16	42.86	9.52		20048	W	A		NBR
30.16	43.65	12.7		20254	W	B	S	NBR
30.16	44.45	4.76		19914	W	A		NBR
30.16	44.45	4.76		59817	W	A	S	NBR
30.16	44.45	6.35		20806	W	A		NBR
30.16	44.45	6.35		56777	W	A		FKM
30.16	44.45	9.52		60078	W	B		NBR
30.16	44.45	11.11		59818	W	A	S	NBR
30.16	44.45	11.11		59679	W	A		NBR
30.16	47.62	7.93		20810	W	A		NBR
30.16	49.21	4.76		59680	W	A		NBR
30.16	49.21	6.35		44853	W	A		NBR
30.16	50.8	6.35		20049	W	A		NBR
30.16	50.8	7.93		76152	W	A		NBR
30.16	50.8	9.52		19924	W	A		NBR
30.16	50.8	9.52		59819	W	A	S	NBR
30.16	52.38	6.35		20050	W	A		NBR
30.5	47	8		38963	W	A	S	NBR
30.96	50.27	6.35		60757	W	B	O	NBR
31	37	3		77838	W	B	O	NBR
31	38.5	4		40737	W	A	O	NBR
31	41	5		19038	W	A		NBR
31	42	12		41366	W	B		NBR
31	43	8		19039	W	A	S	NBR
31	44	7		40735	W	A	S	NBR
31	44.5	5		40738	W	A		NBR
31	44.5	8		40739	W	A		NBR
31	44.5	9.5		40740	W	A	S	NBR
31	44.6	6.7		41367	W	B		NBR
31	46	6		19040	W	A	S	NBR
31	47	7		17263	W	A		NBR
31	47	7		22566	W	A		FKM
31	47	8		38964	W	A	S	NBR
31	47	10		62875	W	A		FKM
31	47	10		17264	W	A		NBR
31	48	7		38965	W	A	S	NBR
31	48	10		38966	W	A	S	NBR
31	49	7		38967	W	A	S	NBR
31	51	7		38968	W	A	S	NBR
31	52	6		17265	W	A		NBR

Any seal. Any time.



d1	d2	H	H2	产品编码	产品组	设计型号	形式	材质
31	52	6		62926	W	A		FKM
31	52	6		39186	W	A	S	NBR
31	52	7		62927	W	A		FKM
31	52	7		17266	W	A		NBR
31	52	8		60219	W	A		NBR
31	52	9		62928	W	A		FKM
31	52	9		17267	W	A		NBR
31	52	12		17268	W	B	S	NBR
31	55	9		63182	W	A		FKM
31	55	9		17269	W	A		NBR
31.5	40	7		19687	W	A		NBR
31.5	45	5.5		41262	W	B	O	NBR
31.5	47	7		38969	W	A		NBR
31.5	52	7		64824	W	A		NBR
31.5	55	11		40741	W	A	S	NBR
31.7	38.1	3.2		41263	W	B	O	NBR
31.7	38.1	4		40742	W	A	O	NBR
31.75	38.1	3.96		61692	W	B	O	NBR
31.75	38.1	3.96		37096	W	A		NBR
31.75	39.69	3.81		60080	W	B		NBR
31.75	39.69	6.35		41492	W	A		NBR
31.75	41.27	6.35		56780	W	A	S	FKM
31.75	41.27	6.35		20802	W	A		NBR
31.75	41.27	6.35		21523	W	A	S	NBR
31.75	42.8	6.35		60081	W	B		NBR
31.75	42.86	4.76		60758	W	B	O	NBR
31.75	42.86	6.35		59820	W	A	S	NBR
31.75	42.86	6.35		60082	W	B		NBR
31.75	42.86	7.93		166493	W	A		NBR
31.75	42.86	7.93		60079	W	B		NBR
31.75	42.86	7.93		60656	W	B	S	NBR
31.75	42.86	9.52		79506	W	B		NBR
31.75	42.86	9.52		20803	W	A		NBR
31.75	44.45	6.35		60657	W	B	S	NBR
31.75	44.45	6.35		20807	W	A		NBR
31.75	44.45	6.35		42641	W	B	O	NBR
31.75	44.45	6.35		132903	W	A	SY	NBR
31.75	44.45	6.35		60083	W	B		NBR
31.75	44.45	7.93		60835	W	C		NBR
31.75	44.45	9.52		40369	W	C		NBR
31.75	44.45	9.52		83170	W	A		FKM
31.75	44.45	9.52		60084	W	B		NBR
31.75	44.45	9.52		59821	W	A	S	NBR
31.75	44.45	9.52		19915	W	A		NBR
31.75	44.45	9.92		20228	W	A		NBR
31.75	44.68	6.35		37097	W	A		NBR
31.75	44.68	9.52		40370	W	C		NBR
31.75	47.62	6.35		20051	W	A		NBR
31.75	47.62	6.35		116982	W	A		FKM
31.75	47.62	7.93		20052	W	A		NBR
31.75	47.62	7.93		60086	W	B		NBR
31.75	47.62	9.52		20053	W	A		NBR
31.75	47.62	9.52		59822	W	A	S	NBR
31.75	47.62	9.52		60087	W	B		NBR
31.75	47.62	9.52		60658	W	B	S	NBR



油封

尺寸



油封

尺寸



d1	d2	H	H2	产品编码	产品组	设计型号	形式	材质
31.75	47.62	11.11		19866	W	A	S	NBR
31.75	49.21	11.11		20811	W	A		NBR
31.75	49.68	11.11		60088	W	B		NBR
31.75	50.01	11.11		60759	W	B	O	NBR
31.75	50.4	6.35		60659	W	B	S	NBR
31.75	50.8	6.35		45064	W	A	S	NBR
31.75	50.8	6.35		40257	W	B	S	NBR
31.75	50.8	6.35		20054	W	A		NBR
31.75	50.8	6.35		60089	W	B		NBR
31.75	50.8	7.93		20237	W	A	S	NBR
31.75	50.8	7.93		20055	W	A		NBR
31.75	50.8	9.52		59823	W	A	S	NBR
31.75	50.8	9.52		20056	W	A		NBR
31.75	50.8	9.52		60090	W	B		NBR
31.75	50.8	9.52		38254	W	A		FKM
31.75	50.8	9.92		60025	W	A	O	NBR
31.75	50.8	10.31		59681	W	A		NBR
31.75	50.8	11.11		60660	W	B	S	NBR
31.75	50.8	12.7		59824	W	A	S	NBR
31.75	50.8	12.7		60091	W	B		NBR
31.75	50.8	12.7		19925	W	A		NBR
31.75	52.38	6.35		60661	W	B	S	NBR
31.75	52.38	9.52		20057	W	A		NBR
31.75	53.38	11.11		20657	W	C	S	NBR
31.75	53.97	6.35		60092	W	B		NBR
31.75	53.97	6.35		60662	W	B	S	NBR
31.75	53.97	7.93		19931	W	A		NBR
31.75	53.97	7.93		163108	W	A	SY	NBR
31.75	53.97	9.52		20058	W	A		NBR
31.75	53.97	9.52		59825	W	A	S	NBR
31.75	55.56	11.11		20813	W	A		NBR
31.75	57.15	7.93		19935	W	A		NBR
31.75	57.15	7.93		135242	W	A	S	NBR
31.75	57.15	7.93		60093	W	B		NBR
31.75	57.15	9.52		59826	W	A	S	NBR
31.75	57.15	9.52		19936	W	A		NBR
31.75	57.15	9.52		60094	W	B		NBR
31.75	57.15	12.7		60095	W	B		NBR
31.75	57.15	12.7		20059	W	A		NBR
31.75	60.32	9.52		20060	W	A		NBR
31.75	61.91	6.35		60096	W	B		NBR
31.75	63.5	6.35		60663	W	B	S	NBR
31.75	63.5	7.93		60097	W	B		NBR
31.75	63.5	9.52		45065	W	A	S	NBR
31.75	63.5	9.52		163109	W	A	SY	NBR
31.75	63.5	9.52		20061	W	A		NBR
31.75	69.85	9.52		20840	W	A		NBR
31.75	72	9.52		59827	W	A	S	NBR
31.75	82.55	11.11		35742	W	A	S	NBR
31.9	44.6	6.4		40736	W	A		NBR
32	40	5		41264	W	B	O	NBR
32	40	5		44665	W	B	S	NBR
32	40	5		40743	W	A		NBR
32	40	5		179314	W	A	S	NBR
32	40	7		84916	W	A	S	FKM

Any seal. Any time.



d1	d2	H	H2	产品编码	产品组	设计型号	形式	材质
32	40	7		78227	W	A		NBR
32	41.25	7		57065	W	A	S	NBR
32	42	4		22081	W	A	OK	NBR
32	42	4		41266	W	B	O	NBR
32	42	5		59428	W	A		NBR
32	42	5		179988	W	A		NBR
32	42	6		38970	W	A		NBR
32	42	6		38971	W	A	S	NBR
32	42	7		38972	W	A	S	NBR
32	42	7		38282	W	A		FKM
32	42	7		19041	W	B		NBR
32	42	7		17270	W	A		NBR
32	42	7		78248	W	B	S	NBR
32	42	8		38973	W	A	S	NBR
32	42	9		40744	W	A		NBR
32	42	14		41271	W	B	O	NBR
32	42.5	6.5		41265	W	B	O	NBR
32	42.7	9		40745	W	A	S	NBR
32	43	5.5		38974	W	A	S	NBR
32	43	7		38975	W	A	S	NBR
32	43	8		40259	W	B		NBR
32	43	10		19042	W	B		NBR
32	44	7		38976	W	A	S	NBR
32	44	7		40746	W	A		NBR
32	44	7		157248	W	A	SY	FKM
32	44	7		157297	W	A	SY	NBR
32	44	8		20218	W	A	S	NBR
32	44	8		175244	W	A	SY	NBR
32	44	9		38977	W	A	S	NBR
32	44	9		19043	W	B		NBR
32	44	10		40747	W	A	S	NBR
32	44	10		74445	W	B	S	NBR
32	44	12		40748	W	A	S	NBR
32	44.5	6.5		41372	W	B		NBR
32	44.5	9		40749	W	A	S	NBR
32	44.5	10		40750	W	A		NBR
32	44.5	12		40751	W	A	S	NBR
32	45	4		22082	W	A	OK	NBR
32	45	5		40753	W	A	S	NBR
32	45	6		17271	W	A		NBR
32	45	6		179492	W	A	S	NBR
32	45	6		62862	W	A		FKM
32	45	7		17272	W	A		NBR
32	45	7		156654	W	A		FKM
32	45	7		19044	W	A	S	NBR
32	45	7		17273	W	B		NBR
32	45	7		20327	W	A		FKM
32	45	7.7		79447	W	A	S	NBR
32	45	8		19045	W	A		NBR
32	45	8		104268	W	A		FKM
32	45	8		39407	W	A	S	NBR
32	45	10		17274	W	A		NBR
32	45	10		19046	W	A	S	NBR
32	45	10		22567	W	A		FKM
32	45	12		40752	W	A	S	NBR



油封

尺寸



油封

尺寸



d1	d2	H	H2	产品编码	产品组	设计型号	形式	材质
32	46	7		39408	W	A	S	NBR
32	46	7		40754	W	A		NBR
32	46	8		41371	W	B		NBR
32	46	8		19047	W	A	S	NBR
32	46	10		68266	W	A		NBR
32	47	4.5		179663	W	A	S	NBR
32	47	6		133559	W	A	SY	FKM
32	47	6		115489	W	A	S	FKM
32	47	6		34897	W	A	SY	NBR
32	47	6		73225	W	A		FKM
32	47	7		56781	W	A	S	FKM
32	47	7		174694	W	A		NBR
32	47	7		157249	W	A	SY	FKM
32	47	7		37249	W	A	S	NBR
32	47	7		179665	W	A	S	NBR
32	47	7		17275	W	A		NBR
32	47	7		17276	W	B		NBR
32	47	7		157298	W	A	SY	NBR
32	47	7		37579	W	B	S	NBR
32	47	7		24863	W	A		FKM
32	47	8		104269	W	A		FKM
32	47	8		130997	W	A	S	NBR
32	47	8		17277	W	A		NBR
32	47	9		17278	W	C		NBR
32	47	9		40755	W	A	S	NBR
32	47	10		17279	W	A		NBR
32	47	10		62895	W	A		FKM
32	47	10		39409	W	A	S	NBR
32	47	10		17280	W	B		NBR
32	47	10		25966	W	B	S	NBR
32	47	10		17281	W	C		NBR
32	47	12		35195	W	A	S	NBR
32	47.5	6		39410	W	A		NBR
32	48	5		19048	W	A		NBR
32	48	6		41267	W	B	O	NBR
32	48	7		39411	W	A	S	NBR
32	48	7		17282	W	A		NBR
32	48	7		17283	W	B		NBR
32	48	7		62899	W	A		FKM
32	48	8		19049	W	A	S	NBR
32	48	8		40260	W	B		NBR
32	48	8		56782	W	A		FKM
32	48	8		88552	W	A	S	FKM
32	48	8		39412	W	A		NBR
32	48	9		17284	W	A		NBR
32	48	10		39414	W	A	S	NBR
32	48	10		39413	W	A		NBR
32	48	11		19050	W	A	S	NBR
32	50	7		19712	W	B		NBR
32	50	7		179309	W	A	S	NBR
32	50	7		19711	W	A		NBR
32	50	7		62511	W	A		FKM
32	50	8		179140	W	A	S	NBR
32	50	8		39415	W	A	S	NBR
32	50	8		48727	W	C		NBR

Any seal. Any time.



d1	d2	H	H2	产品编码	产品组	设计型号	形式	材质
32	50	8		17285	W	A		NBR
32	50	8		62904	W	A		FKM
32	50	10		20328	W	A		FKM
32	50	10		17286	W	A		NBR
32	50	10		17287	W	C		NBR
32	50	10		62905	W	A	S	FKM
32	50	10		35194	W	A	S	NBR
32	50	12		17288	W	A		NBR
32	50	12		62906	W	A		FKM
32	50	12		17289	W	C		NBR
32	51	8		40756	W	A	S	NBR
32	51	8		24235	W	A		NBR
32	51	9		39416	W	A		NBR
32	51	9.5		40758	W	A		NBR
32	51	9.5		40763	W	A	S	NBR
32	51	12		40759	W	A	S	NBR
32	51	19.5		40757	W	A		NBR
32	52	5		17290	W	A		NBR
32	52	6		133486	W	A	SY	NBR
32	52	7		143691	W	A	S	FKM
32	52	7		132614	W	A	SY	FKM
32	52	7		125524	W	A		FKM
32	52	7		56233	W	A	SY	NBR
32	52	7		18702	W	A	S	NBR
32	52	7		17291	W	A		NBR
32	52	7		17292	W	B		NBR
32	52	7		62512	W	A		FKM
32	52	7.5		62929	W	A		FKM
32	52	7.5		17293	W	A		NBR
32	52	8		40617	W	A		NBR
32	52	8		104270	W	A		FKM
32	52	8		19051	W	A	S	NBR
32	52	8		38357	W	B		NBR
32	52	9		17294	W	C		NBR
32	52	9		27029	W	A		NBR
32	52	10		39187	W	A	S	NBR
32	52	10		17295	W	A		NBR
32	52	10		19052	W	B	S	NBR
32	52	10		20329	W	A		FKM
32	52	10		17296	W	B		NBR
32	52	10		17297	W	C		NBR
32	52	11		19053	W	A	S	NBR
32	52	11		41395	W	B	S	NBR
32	52	11		129988	W	A	SY	NBR
32	52	12		17298	W	A		NBR
32	52	12		40261	W	B		NBR
32	52	12		34887	W	C		NBR
32	52	12		17299	W	B	S	NBR
32	52	12		62930	W	A		FKM
32	54	8		39417	W	A		NBR
32	54	10		17300	W	C		NBR
32	54	10		19054	W	A	S	NBR
32	55	8		39418	W	A	S	NBR
32	55	9		77326	W	A	SY	FKM
32	55	10		17302	W	B		NBR



油封

尺寸



油封

尺寸



d1	d2	H	H2	产品编码	产品组	设计型号	形式	材质
32	55	10		17301	W	A		NBR
32	55	10		17303	W	C		NBR
32	55	10		39194	W	A	S	NBR
32	55	10		63183	W	A		FKM
32	55	11		39419	W	A	S	NBR
32	55	12		17304	W	C		NBR
32	56	10		17305	W	A		NBR
32	56	10		63189	W	A	S	FKM
32	56	10		130835	W	A		FKM
32	56	10		59728	W	A		FKM
32	56	10		17306	W	A	S	NBR
32	56	10		17307	W	B		NBR
32	56	10		17308	W	C		NBR
32	56	10		167191	W	A	SY	FKM
32	56	11		39420	W	A	S	NBR
32	56	12		44238	W	A		NBR
32	56	12		19713	W	C		NBR
32	57	7.5		19055	W	A	S	NBR
32	57	9.5		22568	W	A		FKM
32	57	12		26397	W	A		NBR
32	57.15	7		39421	W	A		NBR
32	58	6.5		41268	W	B	O	NBR
32	58	10		40760	W	A	S	NBR
32	58	12		40262	W	B	S	NBR
32	60	10		40761	W	A	S	NBR
32	60	10		17310	W	C		NBR
32	60	10		17309	W	B		NBR
32	60	12		17311	W	C		NBR
32	62	6		19056	W	A		NBR
32	62	7		40762	W	A	S	NBR
32	62	8		19057	W	A		NBR
32	62	8		104271	W	A		FKM
32	62	10		19058	W	A	S	NBR
32	62	10		17312	W	A		NBR
32	62	10		17313	W	C		NBR
32	62	10		63220	W	A		FKM
32	62	12		17314	W	C		NBR
32	62	12		44239	W	A		NBR
32	65	6.5		19059	W	A	S	NBR
32	65	9		39422	W	A	S	NBR
32	65	10		17315	W	B		NBR
32	65	10		17316	W	C		NBR
32	65	12		39423	W	A	S	NBR
32	65	12		17317	W	C		NBR
32	65	13		17318	W	A	S	NBR
32	65	13		40293	W	A	S	FKM
32	66	10		63249	W	A		FKM
32	66	10		17319	W	A		NBR
32	68	10		179527	W	A	S	NBR
32	70	8		22569	W	A		FKM
32	70	8		20673	W	A		NBR
32	72	7		126808	W	A	S	FKM
32	72	8		19060	W	A	S	NBR
32	72	10		19061	W	A	S	NBR
32	72	10		156191	W	A	SY	NBR

Any seal. Any time.



d1	d2	H	H2	产品编码	产品组	设计型号	形式	材质
32	72	12		39424	W	A	S	NBR
32	78	9.5		19062	W	A	S	NBR
32	78	10		19063	W	A	S	NBR
32.54	49.21	12.7		39425	W	A	S	NBR
32.54	51.43	9.52		40263	W	B		NBR
33	40	3		78714	W	B	O	NBR
33	40	3		156106	W	A	OK	NBR
33	42	5		40764	W	A	O	NBR
33	43	7		19789	W	A		NBR
33	43	7		62853	W	A		FKM
33	44	8		19064	W	A	S	NBR
33	44	8.9		39426	W	A	S	NBR
33	45	5.5		41270	W	B	O	NBR
33	45	7		19065	W	A		NBR
33	45	7		56783	W	A		FKM
33	45	10		6310	W	A	S	NBR
33	47	11		83415	W	A		NBR
33	47.5	7.5		40766	W	A		NBR
33	47.5	9.1		40765	W	A	O	NBR
33	48	8.9		19066	W	A	S	NBR
33	48	12		17320	W	A		NBR
33	48	12		62900	W	A		FKM
33	50	6		62907	W	A		FKM
33	50	6		17321	W	A	S	NBR
33	50	6		19067	W	A		NBR
33	50	7		19068	W	A	S	NBR
33	50	7		81231	W	A		NBR
33	50	8		40264	W	B	S	NBR
33	50	8		38629	W	A		NBR
33	50	8		83171	W	A		FKM
33	50	10		20330	W	A		FKM
33	50	10		17322	W	A		NBR
33	50	10		39427	W	A	S	NBR
33	50	11		19069	W	A	S	NBR
33	50	12		17323	W	B	S	NBR
33	50	12		39183	W	A	S	NBR
33	52	2		85235	W	A	OK	NBR
33	52	6		19070	W	A		NBR
33	52	6		62931	W	A		FKM
33	52	8		40767	W	A	S	NBR
33	52	8		19804	W	A		NBR
33	52	8		63163	W	A		FKM
33	52	10		17324	W	A		NBR
33	52	10		104272	W	A		FKM
33	55	10		39428	W	A		NBR
33	56	12		63190	W	A		FKM
33	56	12		19848	W	A		NBR
33	59	12		40768	W	A	S	NBR
33	62	10		17325	W	C		NBR
33	62	12		19749	W	C		NBR
33	72	12		37075	W	C		NBR
33.05	51.99	12.45		60664	W	B	S	NBR
33.33	46.99	6.35		59682	W	A		NBR
33.33	47.22	6.35		59683	W	A		NBR
33.33	47.62	7.93		19919	W	A		NBR



油封

尺寸



油封

尺寸



d1	d2	H	H2	产品编码	产品组	设计型号	形式	材质
33.33	49.21	4.76		69433	W	A		NBR
33.33	50.8	8.05		60098	W	B		NBR
33.33	50.8	9.52		60099	W	B		NBR
33.33	50.9	11.11		40371	W	C		NBR
33.33	53.97	9.52		60665	W	B	S	NBR
33.33	53.97	9.52		59684	W	A		NBR
33.33	55.56	9.52		60666	W	B	S	NBR
33.33	57.15	7.93		60100	W	B		NBR
33.33	57.94	12.7		144053	W	B		NBR
33.33	58.04	12.7		27532	W	B		NBR
33.4	49.3	9.5		66879	W	A		NBR
33.4	58	6.4		41269	W	B	O	NBR
33.5	55	9.5		40265	W	B	S	NBR
33.58	56.57	9.52		60101	W	B		NBR
33.85	63.5	12.7		68260	W	A		NBR
34	42	14		41272	W	B	O	NBR
34	44	6		26398	W	A		NBR
34	44	7		20743	W	A		FKM
34	44	7		19071	W	A		NBR
34	45	7		19072	W	A		NBR
34	45	7		35960	W	A	S	NBR
34	45	7		104273	W	A		FKM
34	45	9		19073	W	A	S	NBR
34	45	11		19074	W	A	S	NBR
34	46	8		34861	W	B		NBR
34	46	8		39429	W	A	S	NBR
34	46	8		39430	W	A		NBR
34	46	10		62865	W	A		FKM
34	46	10		17326	W	A		NBR
34	47	7		19075	W	A	S	NBR
34	47	9		40266	W	B		NBR
34	47	9		38630	W	A		NBR
34	47	12		38631	W	A		NBR
34	48	7		19077	W	A	S	NBR
34	48	7		19076	W	A		NBR
34	48	8		19078	W	A	S	NBR
34	48	8		17327	W	A		NBR
34	48	11		40771	W	A	S	NBR
34	49	8		22570	W	A		FKM
34	49.3	9.5		39431	W	A		NBR
34	50	7		19079	W	A	S	NBR
34	50	8		19080	W	A		NBR
34	50	8		104274	W	A		FKM
34	50	10		17328	W	A		NBR
34	50	10		160894	W	A		NBR
34	50	10		17329	W	C		NBR
34	50	10		62644	W	A		FKM
34	50	11		39432	W	A	S	NBR
34	50	12		39433	W	A	S	NBR
34	50.8	7.8		62911	W	A		FKM
34	51	8		19081	W	A		NBR
34	52	7		17330	W	B		NBR
34	52	7		39193	W	A	S	NBR
34	52	7.5		22571	W	A		FKM
34	52	7.5		17331	W	A		NBR

Any seal. Any time.



油封

尺寸

d1	d2	H	H2	产品编码	产品组	设计型号	形式	材质
34	52	8		40267	W	B		NBR
34	52	8		63164	W	A		FKM
34	52	8		17332	W	A		NBR
34	52	10		17333	W	A		NBR
34	52	10		17334	W	C		NBR
34	52	10		78830	W	A	S	NBR
34	52	10		60221	W	A		FKM
34	52	10		19082	W	B		NBR
34	52	11		17335	W	A		NBR
34	52	11		19083	W	A	S	NBR
34	54	7.5		39434	W	A	S	NBR
34	54	10		40772	W	A	S	NBR
34	54	11		19084	W	A	S	NBR
34	54	11		129989	W	A	SY	NBR
34	54	12.5		26164	W	A	S	NBR
34	55	7		104321	W	A		FKM
34	55	9		17336	W	A		NBR
34	55	9		39435	W	A	S	NBR
34	55	9		63184	W	A		FKM
34	55	10		73226	W	A		FKM
34	58	13		63194	W	A		FKM
34	58	13		17337	W	A		NBR
34	58	13		17338	W	C		NBR
34	62	10		17339	W	A		NBR
34	62	10		63221	W	A		FKM
34	62	10		17340	W	C		NBR
34	62	12		17341	W	C		NBR
34	62.5	8		40773	W	A	S	NBR
34	72	10		19086	W	A	S	NBR
34	72	10		17342	W	C		NBR
34	72	10		19085	W	A		NBR
34	72	12		17343	W	C		NBR
34	72	14.5		17344	W	A	S	NBR
34	72	14.5		63271	W	A	S	FKM
34.13	53.95	7.93		130831	W	A		NBR
34.5	40	4		77585	W	B	O	NBR
34.5	42	4		150028	W	B	O	NBR
34.5	47	7		80137	W	A	S	NBR
34.67	52.86	11.05		60102	W	B		NBR
34.74	47	9		90946	W	A	S	NBR
34.92	47.62	3.17		59685	W	A		NBR
34.92	47.62	6.35		20062	W	A		NBR
34.92	47.62	6.35		60486	W	B		NBR
34.92	47.62	6.35		59828	W	A	S	NBR
34.92	47.62	7.93		59829	W	A	S	NBR
34.92	47.62	7.93		60487	W	B		NBR
34.92	47.62	7.93		19920	W	A		NBR
34.92	49.78	12.7		118422	W	A	S	NBR
34.92	49.9	9.92		76485	W	A		FKM
34.92	50.4	6.35		60760	W	B	O	NBR
34.92	50.4	7.93		60488	W	B		NBR
34.92	50.8	7.93		35747	W	A	S	NBR
34.92	50.8	7.93		37746	W	B		NBR
34.92	50.8	7.93		19926	W	A		NBR
34.92	50.8	7.93		60667	W	B	S	NBR





油封

尺寸



d1	d2	H	H2	产品编码	产品组	设计型号	形式	材质
34.92	50.8	8.33		60489	W	B		NBR
34.92	50.8	8.73		60836	W	C		NBR
34.92	50.8	9.52		20063	W	A		NBR
34.92	50.8	9.52		59830	W	A	S	NBR
34.92	50.8	9.52		60490	W	B		NBR
34.92	50.8	11.11		20848	W	A	S	NBR
34.92	50.8	12.7		20064	W	A		NBR
34.92	52.38	6.35		20245	W	A		NBR
34.92	52.38	9.52		60761	W	A	S	NBR
34.92	52.38	9.52		20065	W	A		NBR
34.92	52.38	12.7		19928	W	A		NBR
34.92	53.38	11.11		75262	W	C	S	NBR
34.92	53.49	7.93		60668	W	B	S	NBR
34.92	53.97	7.93		19932	W	A		NBR
34.92	53.97	7.93		60669	W	B	S	NBR
34.92	53.97	7.93		60491	W	B		NBR
34.92	53.97	9.52		35306	W	B		NBR
34.92	53.97	9.52		59831	W	A	S	NBR
34.92	53.97	9.52		19992	W	A		NBR
34.92	53.97	11.11		60837	W	C		NBR
34.92	54.08	9.52		40372	W	C		NBR
34.92	54.23	7.93		60225	W	A		NBR
34.92	57.15	7.93		40605	W	A	S	NBR
34.92	57.15	7.93		60670	W	B	S	NBR
34.92	57.15	8.3		165138	W	A	SY	FKM
34.92	57.15	9.52		60492	W	B		NBR
34.92	57.15	9.52		19937	W	A		NBR
34.92	57.15	9.52		59832	W	A	S	NBR
34.92	57.15	12.7		19938	W	A		NBR
34.92	57.25	7.93		60671	W	B	S	NBR
34.92	58.73	11.11		59833	W	A	S	NBR
34.92	58.73	11.11		59695	W	A		NBR
34.92	59.13	10.31		56227	W	A	S	NBR
34.92	60.32	9.52		20835	W	A		NBR
34.92	60.32	9.52		59834	W	A	S	NBR
34.92	60.32	12.7		19988	W	A		NBR
34.92	62	7.93		60493	W	B		NBR
34.92	63.5	9.52		60672	W	B	S	NBR
34.92	63.5	9.52		59835	W	A	S	NBR
34.92	63.5	9.52		177650	W	A		NBR
34.92	63.5	9.52		20066	W	A		NBR
34.92	63.5	12.7		19946	W	A		NBR
34.92	63.5	12.7		60673	W	B	S	NBR
34.92	63.5	17.46		60494	W	B		NBR
34.92	63.5	19.05		59836	W	A	S	NBR
34.92	63.8	19.05		24849	W	A	S	NBR
34.92	66.67	9.52		20067	W	A		NBR
34.92	68.26	12.7		60838	W	C		NBR
34.92	68.99	7.93		60674	W	B	S	NBR
34.92	69.85	9.52		37598	W	A		NBR
34.92	69.85	12.7		21027	W	A		NBR
34.92	76.2	9.52		60495	W	B		NBR
35	40	4		81555	W	B	O	NBR
35	42	1.9		84044	W	B	O	NBR
35	42	1.9		162210	W	B	O	NBR

Any seal. Any time.



油封

尺寸

d1	d2	H	H2	产品编码	产品组	设计型号	形式	材质
35	42	3.5		79601	W	B	O	NBR
35	42	4		80802	W	B	O	NBR
35	42	4		110713	W	B	O	NBR
35	42	4		22083	W	A	OK	NBR
35	42	4		48955	W	A	O	FKM
35	42	4		148634	W	B	O	FKM
35	42	8		19087	W	A	S	NBR
35	42	8		68562	W	A		NBR
35	42	8		40487	W	A	O	NBR
35	43	5		40775	W	A	OK	NBR
35	43	6		76213	W	A		NBR
35	44	7		40268	W	B	S	NBR
35	44	7		56785	W	A		FKM
35	44.5	5		40776	W	A		NBR
35	44.7	8		40777	W	A		NBR
35	45	4		22084	W	A	OK	NBR
35	45	4		35083	W	B	O	NBR
35	45	4		79460	W	A	O	FKM
35	45	5		9401	W	B	O	FKM
35	45	5		65118	W	A		NBR
35	45	5		41377	W	B		NBR
35	45	6		41274	W	B	O	NBR
35	45	6		40269	W	B	S	NBR
35	45	6		40778	W	A		NBR
35	45	7		17346	W	A	S	NBR
35	45	7		17345	W	A		NBR
35	45	7		130745	W	A		FKM
35	45	7		20744	W	A		FKM
35	45	7		17347	W	B		NBR
35	45	8		19088	W	A	S	NBR
35	45	10		21002	W	A		NBR
35	45	10		104275	W	A		FKM
35	45	10		179800	W	A	S	NBR
35	45	12		40780	W	A		NBR
35	45	12		40779	W	A	S	NBR
35	45	12		41419	W	C	S	NBR
35	46	6.5		19794	W	A		NBR
35	46	7		39436	W	A	S	NBR
35	46	7		157345	W	A	S	FKM
35	46	8		40270	W	B		NBR
35	47	4		40781	W	A	OK	NBR
35	47	4.5		179661	W	A	S	NBR
35	47	4.5		38365	W	A		NBR
35	47	5		19089	W	A		NBR
35	47	5		87077	W	B	O	NBR
35	47	5		39248	W	B		NBR
35	47	5		170862	W	A	S	NBR
35	47	5		128152	W	A	O	NBR
35	47	5		104276	W	A		FKM
35	47	6		17348	W	A		NBR
35	47	6		34815	W	A	SY	NBR
35	47	6		56786	W	A		FKM
35	47	6		17349	W	B		NBR
35	47	7		17350	W	A		NBR
35	47	7		121488	W	A	SY	NBR





油封

尺寸



d1	d2	H	H2	产品编码	产品组	设计型号	形式	材质
35	47	7		130990	W	A	S	FKM
35	47	7		17352	W	B		NBR
35	47	7		22505	W	A	S	FKM
35	47	7		20331	W	A		FKM
35	47	7		40788	W	C		NBR
35	47	7		130802	W	A		FKM
35	47	7		157250	W	A	SY	FKM
35	47	7		17351	W	A	S	NBR
35	47	7		23724	W	B	S	NBR
35	47	7		175691	W	A	S	NBR
35	47	8		39437	W	A		NBR
35	47	8		39711	W	A	S	NBR
35	47	9		19090	W	A	S	NBR
35	47	10		17353	W	A		NBR
35	47	10		17354	W	B		NBR
35	47	10		17355	W	C		NBR
35	47	10		19091	W	A	S	NBR
35	47	10		62896	W	A		FKM
35	47.3	7		40782	W	A		NBR
35	47.5	5.5		41378	W	B		NBR
35	47.5	8		40783	W	A		NBR
35	48	5		41273	W	B	O	NBR
35	48	6		159374	W	A		FKM
35	48	7		104320	W	A		FKM
35	48	7		39438	W	A	S	NBR
35	48	7		62513	W	A	S	FKM
35	48	8		104277	W	A		FKM
35	48	8		19092	W	A	S	NBR
35	48	8		40271	W	B	S	NBR
35	48	8		24365	W	A		NBR
35	48	9		39439	W	A	S	NBR
35	48	9		62901	W	A		FKM
35	48	9		17356	W	A		NBR
35	48	10		39440	W	A	S	NBR
35	48	12		40784	W	A	S	NBR
35	48	15		39441	W	A	S	NBR
35	49.4	4.5		41379	W	B		NBR
35	49.5	9.5		40272	W	B		NBR
35	49.5	12.5		40273	W	B	S	NBR
35	50	4		40786	W	A	O	NBR
35	50	5		40787	W	A	OK	NBR
35	50	5		40792	W	A		NBR
35	50	7		37302	W	A	S	NBR
35	50	7		38683	W	B	S	NBR
35	50	7		130816	W	A		FKM
35	50	7		7839	W	A	SY	NBR
35	50	7		38947	W	A	S	FKM
35	50	7		17357	W	A		NBR
35	50	7		17358	W	B		NBR
35	50	7		20332	W	A		FKM
35	50	7		163261	W	B		NBR
35	50	8		40794	W	A	O	NBR
35	50	8		56787	W	A		FKM
35	50	8		56794	W	A	S	FKM
35	50	8		19093	W	A	S	NBR

Any seal. Any time.



油封

尺寸

d1	d2	H	H2	产品编码	产品组	设计型号	形式	材质
35	50	8		44281	W	B		NBR
35	50	8		17359	W	A		NBR
35	50	9		40373	W	C		NBR
35	50	10		17362	W	B	S	NBR
35	50	10		17364	W	C	S	NBR
35	50	10		17360	W	A		NBR
35	50	10		17361	W	B		NBR
35	50	10		17363	W	C		NBR
35	50	10		62908	W	A	S	FKM
35	50	10		19094	W	A	S	NBR
35	50	10		20333	W	A		FKM
35	50	10		130862	W	A		FKM
35	50	11		39442	W	A	S	NBR
35	50	12		17366	W	B	S	NBR
35	50	12		17367	W	C		NBR
35	50	12		17368	W	C	S	NBR
35	50	12		39443	W	A	S	NBR
35	50	12		17365	W	B		NBR
35	51	8		39444	W	A		NBR
35	51	9		40795	W	A	S	NBR
35	51	9.5		41425	W	B	S	NBR
35	51	12		41420	W	C	S	NBR
35	51	12		19095	W	A	S	NBR
35	51	14		40785	W	A	S	NBR
35	52	5.5		56795	W	A	S	FKM
35	52	6		22506	W	A	S	FKM
35	52	6		48621	W	A	SY	FKM
35	52	6		56981	W	A	S	NBR
35	52	6		24349	W	A	SY	NBR
35	52	7		63165	W	A	S	FKM
35	52	7		20334	W	A		FKM
35	52	7		17369	W	A		NBR
35	52	7		17371	W	B		NBR
35	52	7		131052	W	A	S	FKM
35	52	7		69012	W	B	S	NBR
35	52	7		40374	W	C		NBR
35	52	7		124747	W	A		FKM
35	52	7		131108	W	A	O	NBR
35	52	7		17370	W	A	S	NBR
35	52	8		104278	W	A		FKM
35	52	8		19096	W	A	S	NBR
35	52	8		17373	W	A		NBR
35	52	8.5		19097	W	A		NBR
35	52	8.7		40274	W	B		NBR
35	52	8.8		19805	W	B		NBR
35	52	8.8		63166	W	A		FKM
35	52	8.8		17372	W	A		NBR
35	52	9		17376	W	C		NBR
35	52	9		19098	W	A	S	NBR
35	52	9		17375	W	B	S	NBR
35	52	9		19714	W	B		NBR
35	52	9		17377	W	C	S	NBR
35	52	9		27294	W	A		NBR
35	52	10		19715	W	B		NBR
35	52	10		17378	W	A		NBR





油封

尺寸





















d1	d2	H	H2	产品编码	产品组	设计型号	形式	材质
35	52	10		17380	W	C		NBR
35	52	10		20335	W	A		FKM
35	52	10		17379	W	A	S	NBR
35	52	10		38747	W	C	S	NBR
35	52	10		22507	W	A	S	FKM
35	52	10		39047	W	B	S	NBR
35	52	11		19099	W	A	S	NBR
35	52	12		17382	W	B	S	NBR
35	52	12		19100	W	A		NBR
35	52	12		39445	W	A	S	NBR
35	52	12		17384	W	C	S	NBR
35	52	12		19716	W	B		NBR
35	52	12		17383	W	C		NBR
35	52	12		63167	W	A		FKM
35	52	16		118844	W	C	S	FKM
35	52.5	12		40797	W	A	S	NBR
35	52.5	12.8		40793	W	A	S	NBR
35	53	7		156996	W	A		NBR
35	53	8		83416	W	A		NBR
35	53	9		57150	W	A		FKM
35	54	8		39446	W	A	S	NBR
35	54	8		19844	W	A		NBR
35	54	8		63177	W	A		FKM
35	54	9.5		40798	W	A	S	NBR
35	54	10		19101	W	A		NBR
35	54	10		39447	W	A	S	NBR
35	54	10		22572	W	A		FKM
35	55	5		39448	W	A		NBR
35	55	5		39056	W	B	O	NBR
35	55	5		40488	W	A	O	NBR
35	55	7		170863	W	A	S	NBR
35	55	7		62514	W	A	S	FKM
35	55	8		38734	W	C		NBR
35	55	8		130817	W	A		FKM
35	55	8		63185	W	A		FKM
35	55	8		40275	W	B	S	NBR
35	55	8		17385	W	A		NBR
35	55	8		17386	W	B		NBR
35	55	8		19102	W	A	S	NBR
35	55	9		19103	W	A	S	NBR
35	55	10		17387	W	A		NBR
35	55	10		17388	W	A	S	NBR
35	55	10		17390	W	C		NBR
35	55	10		130855	W	A		FKM
35	55	10		20336	W	A		FKM
35	55	10		35069	W	A		NBR
35	55	10		78245	W	A	Y	NBR
35	55	10		17389	W	B		NBR
35	55	10		73227	W	A	S	FKM
35	55	11		19104	W	A	S	NBR
35	55	11		40276	W	B	S	NBR
35	55	11		44802	W	A	S	FKM
35	55	11		131165	W	A	SY	FKM
35	55	11		40799	W	A		NBR
35	55	11		41376	W	B		NBR

Any seal. Any time.

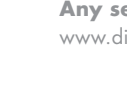

油封

尺寸

d1	d2	H	H2	产品编码	产品组	设计型号	形式	材质	
35	55	11		129990	W	A	SY	NBR	
35	55	12		104279	W	A		FKM	
35	55	12		39449	W	A	S	NBR	
35	55	12		17391	W	B		NBR	
35	55	12		17392	W	C		NBR	
35	55	12		19105	W	A		NBR	
35	55	16		175318	W	B		NBR	
35	55.5	9		38439	W	A		NBR	
35	56	8		63191	W	A		FKM	
35	56	8		17393	W	A		NBR	
35	56	9		39450	W	A	S	NBR	
35	56	10		17397	W	C	S	NBR	
35	56	10		20337	W	A		FKM	
35	56	10		35814	W	A	S	NBR	
35	56	10		17394	W	A		NBR	
35	56	10		17395	W	B	S	NBR	
35	56	10		17396	W	C		NBR	
35	56	10		19717	W	B		NBR	
35	56	12		17399	W	A	S	NBR	
35	56	12		17401	W	C		NBR	
35	56	12		17402	W	C	S	NBR	
35	56	12		19106	W	B		NBR	
35	56	12		63192	W	A	S	FKM	
35	56	12		17398	W	A		NBR	
35	56	12		17400	W	B	S	NBR	
35	56	12		104280	W	A		FKM	
35	57	8		40800	W	A	S	NBR	
35	57	10		26399	W	A		NBR	
35	57.15	10		19850	W	B		NBR	
35	58	7		39451	W	A	S	NBR	
35	58	7		40802	W	A		NBR	
35	58	7.5		17403	W	A		NBR	
35	58	7.5		63195	W	A		FKM	
35	58	8		39452	W	A	S	NBR	
35	58	10		63196	W	A		FKM	
35	58	10		163360	W	A	S	FKM	
35	58	10		17404	W	A		NBR	
35	58	10		17405	W	B		NBR	
35	58	10		40375	W	C		NBR	
35	58	10		39453	W	A	S	NBR	
35	58	12		17407	W	C		NBR	
35	58	12		63197	W	A		FKM	
35	58	12		17406	W	A		NBR	
35	58	12		19107	W	A	S	NBR	
35	58	13		17408	W	B		NBR	
35	58	13		17409	W	C		NBR	
35	59.5	12		40803	W	A		NBR	
35	60	5		40804	W	A		NBR	
35	60	8		40805	W	A		NBR	
35	60	10		63204	W	A		FKM	
35	60	10		39454	W	A	S	NBR	
35	60	10		17410	W	A		NBR	
35	60	10		17412	W	C		NBR	
35	60	10		17411	W	B		NBR	
35	60	12		17413	W	A		NBR	



油封

尺寸



d1	d2	H	H2	产品编码	产品组	设计型号	形式	材质
35	60	12		19108	W	A	S	NBR
35	60	12		17414	W	C		NBR
35	60	12		63205	W	A		FKM
35	62	5		27574	W	B		NBR
35	62	5		40806	W	A	OK	NBR
35	62	5.5		17415	W	B		NBR
35	62	6		39455	W	A	S	NBR
35	62	7		17416	W	A		NBR
35	62	7		36445	W	A	S	FKM
35	62	7		20338	W	A		FKM
35	62	7		19720	W	B	S	NBR
35	62	7		150826	W	A	SY	FKM
35	62	7		17417	W	B		NBR
35	62	7		157299	W	A	SY	NBR
35	62	7		34807	W	A	S	NBR
35	62	7		130600	W	A	S	FKM
35	62	8		63222	W	A	S	FKM
35	62	8		17418	W	A	S	NBR
35	62	8		39456	W	A		NBR
35	62	8		17419	W	B		NBR
35	62	9		17420	W	C		NBR
35	62	10		17423	W	B	S	NBR
35	62	10		20339	W	A		FKM
35	62	10		17421	W	A		NBR
35	62	10		17422	W	A	S	NBR
35	62	10		17424	W	C		NBR
35	62	10		19109	W	B		NBR
35	62	10		104344	W	A	S	FKM
35	62	12		17426	W	A	S	NBR
35	62	12		19721	W	B		NBR
35	62	12		63223	W	A		FKM
35	62	12		17425	W	A		NBR
35	62	12		60255	W	C		FKM
35	62	12		17429	W	C	S	NBR
35	62	12		17427	W	B	S	NBR
35	62	12		17428	W	C		NBR
35	62	12		63224	W	A	S	FKM
35	63.5	9		39457	W	A	S	NBR
35	64	8		39458	W	A		NBR
35	64	9		39459	W	A	S	NBR
35	64	12		39460	W	A	S	NBR
35	64	13		39461	W	A	S	NBR
35	65	9		63239	W	A		FKM
35	65	9		17430	W	A		NBR
35	65	10		17431	W	B		NBR
35	65	10		17432	W	C		NBR
35	65	10		18703	W	A	S	NBR
35	65	10		104281	W	A		FKM
35	65	10		19110	W	A		NBR
35	65	12		17435	W	C		NBR
35	65	12		40277	W	B	S	NBR
35	65	12		17434	W	B		NBR
35	65	12		17003	W	A	S	NBR
35	65	12		63240	W	A		FKM
35	65	12		17433	W	A		NBR

Any seal. Any time.



油封

尺寸

d1	d2	H	H2	产品编码	产品组	设计型号	形式	材质
35	67	7		83417	W	A		NBR
35	68	6		17436	W	A		NBR
35	68	6		22573	W	A		FKM
35	68	10		17437	W	A		NBR
35	68	10		24429	W	A		FKM
35	68	10		39462	W	A	S	NBR
35	68	10		172482	W	A	S	FKM
35	68	12		40807	W	A	S	NBR
35	68	12		63255	W	A		FKM
35	68	12		17438	W	A		NBR
35	70	10		17439	W	B		NBR
35	70	10		17440	W	C		NBR
35	70	10		39463	W	A	S	NBR
35	70	12		17441	W	B		NBR
35	70	12		17442	W	C		NBR
35	72	7		130851	W	A		FKM
35	72	7		124582	W	A	S	FKM
35	72	7		49578	W	A		FKM
35	72	7		73078	W	A	S	NBR
35	72	7		39464	W	A		NBR
35	72	7		176386	W	A		NBR
35	72	7		17443	W	B	S	NBR
35	72	8		39465	W	A	S	NBR
35	72	9.8		39466	W	A	S	NBR
35	72	10		17445	W	B		NBR
35	72	10		81536	W	A	S	FKM
35	72	10		17444	W	A		NBR
35	72	10		17446	W	B	S	NBR
35	72	10		156900	W	A	SY	NBR
35	72	10		19111	W	A	S	NBR
35	72	10		17447	W	C		NBR
35	72	10		20340	W	A		FKM
35	72	12		63272	W	A		FKM
35	72	12		17448	W	A		NBR
35	72	12		17449	W	A	S	NBR
35	72	12		17450	W	B		NBR
35	72	12		17452	W	C		NBR
35	72	12		63273	W	A	S	FKM
35	72	12		17451	W	B	S	NBR
35	76	9		39467	W	A	S	NBR
35	78	8		39468	W	A	S	NBR
35	80	7		156899	W	A	SY	NBR
35	80	8		44561	W	A	S	NBR
35	80	8		162752	W	A	SY	NBR
35	80	8		117038	W	A		NBR
35	80	10		27597	W	A	S	NBR
35	80	10		24343	W	A		NBR
35	80	10		104282	W	A		FKM
35	80	12		36617	W	A		NBR
35	80	12		34804	W	A	S	NBR
35	80	12		17453	W	C		NBR
35	80	12		104283	W	A		FKM
35	80	12		127007	W	A	S	FKM
35	80	13		35187	W	A		NBR
35	80	13		38684	W	B	S	NBR





油封

尺寸





















d1	d2	H	H2	产品编码	产品组	设计型号	形式	材质
35	80	13		34802	W	A	S	NBR
35	80	13		17454	W	C		NBR
35	90	10		170575	W	A		NBR
35.2	57.3	12.7		48728	W	C		NBR
35.4	51	12		40796	W	A	S	NBR
35.5	44	9		39469	W	A	S	NBR
35.7	63.3	9.3		39470	W	A		NBR
35.8	68	10		44282	W	B		NBR
35.8	68	10		44222	W	A		NBR
36	42	3.5		129722	W	B	O	NBR
36	42	3.5		162214	W	B	O	NBR
36	42	4		176948	W	A	OK	NBR
36	42	4		163308	W	B	O	NBR
36	44	4		68267	W	A	O	NBR
36	44	5		68268	W	A	O	NBR
36	47	7		39471	W	A	S	NBR
36	47	7		20226	W	B		NBR
36	47	7		17455	W	A		NBR
36	47	7		62515	W	A		FKM
36	47	7		178621	W	A		NBR
36	48	5		129723	W	A	SY	NBR
36	48	10		39477	W	A	S	NBR
36	48	10		17456	W	A		NBR
36	48	10		22574	W	A		FKM
36	48	12		40808	W	A		NBR
36	50	6		39478	W	A	S	NBR
36	50	7		39048	W	B	S	NBR
36	50	7		62516	W	A	S	FKM
36	50	7		118736	W	A		FKM
36	50	7		83172	W	A		FKM
36	50	7		17457	W	A		NBR
36	50	7		40376	W	C	S	NBR
36	50	7		19112	W	A	S	NBR
36	50	8		40810	W	A	S	NBR
36	50	9		60257	W	C		NBR
36	50	9		40809	W	A	S	NBR
36	50	10		56796	W	A		FKM
36	50	10		17458	W	A		NBR
36	50.8	8		43928	W	B	S	NBR
36	50.8	8		117884	W	B		NBR
36	51	8		40811	W	A	S	NBR
36	51	12		41426	W	B	S	NBR
36	52	5		40813	W	A		NBR
36	52	6		22508	W	A	S	FKM
36	52	6.5		74061	W	A		NBR
36	52	7		62517	W	A		FKM
36	52	7		22509	W	A	S	FKM
36	52	7		40812	W	A	S	NBR
36	52	7		151462	W	B		NBR
36	52	7		17459	W	A		NBR
36	52	9		40278	W	B		NBR
36	52	9		17460	W	A	S	NBR
36	52	9		63168	W	A	S	FKM
36	52	10		39480	W	A	S	NBR
36	53	9		39481	W	A	S	NBR

Any seal. Any time.

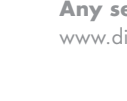

油封

尺寸

d1	d2	H	H2	产品编码	产品组	设计型号	形式	材质	
36	54	6.5		19113	W	A		NBR	
36	54	7		39482	W	A	S	NBR	
36	54	7		40279	W	B	S	NBR	
36	54	7		41432	W	C		NBR	
36	54	7		39058	W	A		NBR	
36	54	7.5		17461	W	A		NBR	
36	54	7.5		22575	W	A		FKM	
36	54	7.5		37202	W	C		NBR	
36	54	7.5		39483	W	A	S	NBR	
36	54	10		44223	W	A		NBR	
36	54	10		39484	W	A	S	NBR	
36	54	10		44283	W	B		NBR	
36	54	11		39485	W	A	S	NBR	
36	55	11		40280	W	B	S	NBR	
36	56	6		39486	W	A		NBR	
36	56	9		39487	W	A	S	NBR	
36	56	9		17462	W	B	S	NBR	
36	56	10		17464	W	B		NBR	
36	56	10		17463	W	A		NBR	
36	56	10		60592	W	A		FKM	
36	56	12		40377	W	C		NBR	
36	58	9		40814	W	A		NBR	
36	58	10		18704	W	A	S	NBR	
36	58	10		18693	W	A		NBR	
36	58	10		48626	W	A		FKM	
36	58	12		17465	W	A		NBR	
36	58	12		38638	W	A	S	NBR	
36	58	12		63198	W	A		FKM	
36	58	15		149995	W	A	S	NBR	
36	59	9.5		17467	W	A		NBR	
36	59.3	9		39488	W	A	S	NBR	
36	60	10		39491	W	A	S	NBR	
36	62	7		17468	W	A		NBR	
36	62	7		22510	W	A	S	FKM	
36	62	7		19114	W	A	S	NBR	
36	62	7		63225	W	A		FKM	
36	62	8		40281	W	B		NBR	
36	62	9		36571	W	C		NBR	
36	62	10		38733	W	C		NBR	
36	62	10		17469	W	A		NBR	
36	62	10		63227	W	A		FKM	
36	63	12		75263	W	C	S	NBR	
36	63.4	12.5		39492	W	A	S	NBR	
36	63.5	12		39493	W	A	S	NBR	
36	65	10		48627	W	A		FKM	
36	68	10		17471	W	B		NBR	
36	68	10		175592	W	A	S	NBR	
36	68	10		17470	W	A		NBR	
36	68	10		17472	W	B	S	NBR	
36	68	10		63256	W	A		FKM	
36	68	10		39494	W	A	S	NBR	
36	72	12		40378	W	C		NBR	
36	75	12		19864	W	A		NBR	
36	75	12		63297	W	A		FKM	
36	83	12		69356	W	A		NBR	



油封

尺寸



d1	d2	H	H2	产品编码	产品组	设计型号	形式	材质
36.51	47.62	6.35		134034	W	A	S	FKM
36.51	50.8	7.93		37744	W	B		NBR
36.51	50.8	7.93		34925	W	A	S	NBR
36.51	50.8	7.93		134031	W	A	S	FKM
36.51	52.38	7.93		59837	W	A	S	NBR
36.51	52.38	7.93		60762	W	B	S	NBR
36.51	52.58	7.93		44208	W	A	S	NBR
36.51	53.97	6.35		21025	W	A		NBR
36.51	55.66	12.7		24848	W	B	S	NBR
36.51	57.15	7.93		41539	W	A		FKM
36.51	57.15	9.52		20068	W	A		NBR
36.51	57.15	9.52		59839	W	A	S	NBR
36.51	59.13	6.35		59838	W	A	S	NBR
36.51	60.32	9.52		37488	W	A		NBR
36.51	63.5	12.7		20069	W	A		NBR
36.51	63.5	12.7		60496	W	B		NBR
36.51	73.02	15.87		35745	W	A	S	NBR
37	47	4		48956	W	A	O	FKM
37	47	4		22085	W	A	OK	NBR
37	48	6		77851	W	A	S	NBR
37	50	7		39495	W	A	S	NBR
37	50	10		19800	W	A		NBR
37	50.8	8		41428	W	B	S	NBR
37	51	8		41427	W	B	S	NBR
37	52	7		83239	W	A		NBR
37	52	8		20483	W	A		FKM
37	52	8		39496	W	A		NBR
37	52	10		22576	W	A		FKM
37	52	10		60227	W	A		NBR
37	52	10		39497	W	A	S	NBR
37	52	10		40379	W	C		NBR
37	52	12		117910	W	A	S	NBR
37	53	7		40815	W	A	S	NBR
37	55	8		19115	W	A	S	NBR
37	55	9		40380	W	C		NBR
37	57	10		41380	W	B		NBR
37	58	13		40381	W	C		NBR
37	58	13		74780	W	A		NBR
37	62	7		39498	W	A	S	NBR
37	62	8		17473	W	A		NBR
37	62	8		63228	W	A		FKM
37	62	8		74257	W	C		NBR
37	62	9		40382	W	C		NBR
37	62	10		39490	W	A		NBR
37	62	11		17474	W	A		NBR
37	62	12		35001	W	A		NBR
37	62	14		39519	W	B	S	NBR
37	62	14		40449	W	C	S	NBR
37	72	12		19856	W	A		NBR
37	72	12		63274	W	A		FKM
37	80	13		17475	W	C		NBR
37.5	52.4	8		19808	W	A		NBR
37.5	52.6	12.5		63176	W	A	S	FKM
37.85	59.06	9.83		60675	W	B	S	NBR
38	42	3		41276	W	B	O	NBR



















Any seal. Any time.

www.dichtomatik.de

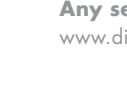

油封

尺寸

d1	d2	H	H2	产品编码	产品组	设计型号	形式	材质	
38	43	3		35385	W	B	O	NBR	
38	45	3		46548	W	B	O	NBR	
38	45	4		125202	W	B	O	NBR	
38	47	9		41277	W	B	O	NBR	
38	47	10		39499	W	A	S	NBR	
38	47.7	4.8		41381	W	B		NBR	
38	48	4		22086	W	A	OK	NBR	
38	48	4		116657	W	B	O	NBR	
38	48	6		77850	W	A	S	NBR	
38	48	6		39500	W	A		NBR	
38	48	6		40489	W	A	O	NBR	
38	48	7		40816	W	A		NBR	
38	48	10		39501	W	A	S	NBR	
38	50	6		45116	W	A	SY	NBR	
38	50	6		157251	W	A	SY	FKM	
38	50	7		17476	W	A		NBR	
38	50	7		19750	W	B		NBR	
38	50	7		39184	W	A	S	NBR	
38	50	7		130863	W	A		FKM	
38	50	7		20341	W	A		FKM	
38	50	8		19116	W	A		NBR	
38	50	8		19117	W	A	S	NBR	
38	50	8		44635	W	A		FKM	
38	50	8		41382	W	B		NBR	
38	50	10		104284	W	A		FKM	
38	50	10		24362	W	A		NBR	
38	50	10		19118	W	A	S	NBR	
38	50	10		174859	W	B		NBR	
38	50	11		39502	W	A	S	NBR	
38	50	12		40817	W	A	S	NBR	
38	51	7.54		39503	W	A	S	NBR	
38	52	6		39504	W	A	S	NBR	
38	52	7		22237	W	A	S	FKM	
38	52	7		20342	W	A		FKM	
38	52	7		39505	W	A	S	NBR	
38	52	7		17478	W	B	S	NBR	
38	52	7		19722	W	B		NBR	
38	52	7		175593	W	A	S	NBR	
38	52	7		131059	W	A	S	FKM	
38	52	7		27462	W	A		NBR	
38	52	7		130749	W	A		FKM	
38	52	8		41421	W	C	S	NBR	
38	52	8		63169	W	A		FKM	
38	52	8		39506	W	A	S	NBR	
38	52	8		38650	W	B		NBR	
38	52	8		17479	W	A		NBR	
38	52	8.5		39507	W	A	S	NBR	
38	52	9		39508	W	A		NBR	
38	52	9		19119	W	A	S	NBR	
38	52	9.5		19120	W	A	S	NBR	
38	52	10		39509	W	A	S	NBR	
38	52	10		17480	W	A		NBR	
38	52	10		17482	W	C		NBR	
38	52	10		17481	W	B		NBR	
38	52	10		63170	W	A		FKM	



油封

尺寸



d1	d2	H	H2	产品编码	产品组	设计型号	形式	材质
38	53	5		40818	W	A	O	NBR
38	53	8		39510	W	A		NBR
38	53	10		40819	W	A	S	NBR
38	54	6		40282	W	B	S	NBR
38	54	6.5		56797	W	A		FKM
38	54	6.5		38089	W	A		NBR
38	54	10		17483	W	A		NBR
38	54	10		17485	W	C		NBR
38	54	10		63178	W	A		FKM
38	54	10		39511	W	A	S	NBR
38	54	10		17484	W	B		NBR
38	54	11		41429	W	B	S	NBR
38	55	6		17486	W	A		NBR
38	55	6		63186	W	A		FKM
38	55	7		19121	W	A		NBR
38	55	7		17487	W	B		NBR
38	55	7		39512	W	A	S	NBR
38	55	7		62518	W	A		FKM
38	55	7		122477	W	A	S	FKM
38	55	8		19122	W	A	S	NBR
38	55	9		17488	W	C		NBR
38	55	9		19123	W	A	S	NBR
38	55	10		17489	W	A	S	NBR
38	55	10		63187	W	A	S	FKM
38	55	10		104285	W	A		FKM
38	55	10		19723	W	B		NBR
38	55	10		27594	W	A		NBR
38	55	10		19751	W	C		NBR
38	55	10.5		19124	W	A		NBR
38	55	11		40820	W	A		NBR
38	55	12		19724	W	C		NBR
38	55.5	9		19847	W	A		NBR
38	55.5	9		40283	W	B		NBR
38	56	7		179310	W	A	S	NBR
38	56	7		56917	W	A		NBR
38	56	9		40821	W	A	S	NBR
38	56	10		20343	W	A		FKM
38	56	10		17491	W	C		NBR
38	56	10		44284	W	B		NBR
38	56	10		39513	W	A	S	NBR
38	56	10		17490	W	A		NBR
38	56	11		81233	W	A		NBR
38	56	11		40284	W	B	S	NBR
38	56	12		39514	W	A		NBR
38	56	12		17492	W	C		NBR
38	56	12		38651	W	B		NBR
38	57	7		40822	W	A	S	NBR
38	57	10		26400	W	A		NBR
38	57.2	9.5		41275	W	B	O	NBR
38	57.5	8		40823	W	A		NBR
38	58	5		39016	W	A	O	NBR
38	58	5		39515	W	A		NBR
38	58	7		19125	W	A	S	NBR
38	58	8		39516	W	A	S	NBR
38	58	8		40285	W	B	S	NBR



















Any seal. Any time.

www.dichtomatik.de

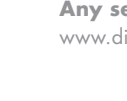

油封

尺寸

d1	d2	H	H2	产品编码	产品组	设计型号	形式	材质	
38	58	8		37107	W	A		NBR	
38	58	10		104286	W	A		FKM	
38	58	10		44285	W	B		NBR	
38	58	10		44224	W	A		NBR	
38	58	10		39517	W	A	S	NBR	
38	58	11		40286	W	B	S	NBR	
38	58	11		19127	W	A	S	NBR	
38	58	11		19126	W	A		NBR	
38	58	11		129991	W	A	SY	NBR	
38	58	12		17493	W	C		NBR	
38	58.3	9		40824	W	A	S	NBR	
38	58.5	7		40825	W	A		NBR	
38	59	8		39518	W	A	S	NBR	
38	60	7		62519	W	A		FKM	
38	60	8		39520	W	A	S	NBR	
38	60	10		39521	W	A	S	NBR	
38	60	10		17494	W	A		NBR	
38	60	10		17495	W	C		NBR	
38	60	10		20344	W	A		FKM	
38	60	12		38732	W	C		NBR	
38	60	12		19128	W	A		NBR	
38	60	12		104287	W	A		FKM	
38	60	13		41430	W	B	S	NBR	
38	60.5	12		39522	W	A	S	NBR	
38	62	4		124841	W	A	OK	NBR	
38	62	7		38469	W	A	S	NBR	
38	62	7		157300	W	A	SY	NBR	
38	62	7		157252	W	A	SY	FKM	
38	62	7		22511	W	A	S	FKM	
38	62	7		19129	W	A		NBR	
38	62	7		62520	W	A		FKM	
38	62	7		40287	W	B	S	NBR	
38	62	7		19726	W	B		NBR	
38	62	8		19130	W	A		NBR	
38	62	8		40288	W	B		NBR	
38	62	8		104288	W	A		FKM	
38	62	8		39523	W	A	S	NBR	
38	62	8.5		24700	W	A	S	NBR	
38	62	9		19131	W	A		NBR	
38	62	9		39524	W	A	S	NBR	
38	62	9		19727	W	C		NBR	
38	62	10		20345	W	A		FKM	
38	62	10		73228	W	A	S	FKM	
38	62	10		39525	W	A	S	NBR	
38	62	10		17496	W	A		NBR	
38	62	10		130799	W	A		FKM	
38	62	10		17497	W	B	S	NBR	
38	62	10		17498	W	C		NBR	
38	62	11		39526	W	A	S	NBR	
38	62	11		40289	W	B	S	NBR	
38	62	11.5		19728	W	A		NBR	
38	62	12		39017	W	A	O	NBR	
38	62	12		63229	W	A		FKM	
38	62	12		17500	W	C		NBR	
38	62	12		27001	W	B		NBR	



油封

尺寸



d1	d2	H	H2	产品编码	产品组	设计型号	形式	材质
38	62	12		40826	W	A	S	NBR
38	62	12		17499	W	A		NBR
38	63	9		39527	W	A	S	NBR
38	63.5	9.5		63236	W	A		FKM
38	64	12		26401	W	A		NBR
38	65	8		39528	W	A		NBR
38	65	8		36037	W	A		FKM
38	65	9		40290	W	B	S	NBR
38	65	9		81236	W	A		NBR
38	65	10		39529	W	A	S	NBR
38	65	10		104289	W	A		FKM
38	65	10		17501	W	A		NBR
38	65	10		17502	W	C		NBR
38	65	12		40291	W	B		NBR
38	68	10		39530	W	A	S	NBR
38	70	10		17504	W	C		NBR
38	70	10		17503	W	B		NBR
38	70	12		17505	W	C		NBR
38	70	12		44240	W	A		NBR
38	70	12		61728	W	B		NBR
38	72	8		39531	W	A	S	NBR
38	72	10		39532	W	A	S	NBR
38	72	10		17507	W	B		NBR
38	72	10		63275	W	A		FKM
38	72	10		17506	W	A		NBR
38	72	10		17508	W	C		NBR
38	72	12		39533	W	A		NBR
38	72	12		17510	W	C		NBR
38	72	12		17509	W	B		NBR
38	74	10		19858	W	A		NBR
38	74	10		19859	W	B		NBR
38	74	10		63294	W	A		FKM
38	74	11		39534	W	A	S	NBR
38	74	11		40292	W	B	S	NBR
38	75	5		40828	W	A		NBR
38	75	10		40827	W	A	S	NBR
38	80	10		72816	W	A		NBR
38	80	12		39535	W	A		NBR
38.1	47.62	4.76		157028	W	B	S	NBR
38.1	47.62	6.35		60497	W	B		NBR
38.1	47.62	9.52		20070	W	A		NBR
38.1	50.29	12.7		83418	W	A		NBR
38.1	50.4	7.93		60498	W	B		NBR
38.1	50.8	5.56		59696	W	A		NBR
38.1	50.8	6.35		56553	W	A	S	NBR
38.1	50.8	6.35		60499	W	B		NBR
38.1	50.8	6.35		19927	W	A		NBR
38.1	50.8	9.52		60677	W	B	S	NBR
38.1	50.8	12.7		20071	W	A		NBR
38.1	52.38	6.35		60500	W	B		NBR
38.1	52.38	6.35		59840	W	A	S	NBR
38.1	52.38	6.35		19929	W	A		NBR
38.1	52.38	7.93		19930	W	A		NBR
38.1	52.38	9.52		20072	W	A		NBR
38.1	53.97	9.52		59841	W	A	S	NBR

Any seal. Any time.



油封

尺寸

d1	d2	H	H2	产品编码	产品组	设计型号	形式	材质
38.1	53.97	9.52		60501	W	B		NBR
38.1	53.97	9.52		20073	W	A		NBR
38.1	54.96	7.14		79893	W	B		NBR
38.1	55.56	7.93		20074	W	A		NBR
38.1	55.56	9.52		19934	W	A		NBR
38.1	57.15	6.35		59697	W	A		NBR
38.1	57.15	7.93		132904	W	A	SY	NBR
38.1	57.15	7.93		20075	W	A		NBR
38.1	57.15	7.93		60502	W	B		NBR
38.1	57.15	9.52		19939	W	A		NBR
38.1	57.15	9.52		56210	W	A		NBR
38.1	57.15	9.52		59842	W	A	S	NBR
38.1	57.15	9.52		20678	W	B		NBR
38.1	57.15	9.52		149273	W	A	S	FKM
38.1	57.15	9.52		40383	W	C		NBR
38.1	57.15	12.7		39536	W	A	S	NBR
38.1	57.15	12.7		19940	W	A		NBR
38.1	57.2	12.7		74245	W	C		NBR
38.1	57.4	10.31		60892	W	C	S	NBR
38.1	59.13	9.83		60676	W	B	S	NBR
38.1	60.32	9.52		19993	W	A		NBR
38.1	60.32	9.52		59843	W	A	S	NBR
38.1	60.32	11.11		59698	W	A		NBR
38.1	60.32	11.5		60679	W	B	S	NBR
38.1	60.32	12.7		60503	W	B		NBR
38.1	60.32	12.7		20076	W	A		NBR
38.1	60.32	14.28		60678	W	B	S	NBR
38.1	61.91	7.93		60504	W	B		NBR
38.1	61.91	9.52		20837	W	A		NBR
38.1	63.5	6.35		20077	W	A		NBR
38.1	63.5	7.93		19947	W	A		NBR
38.1	63.5	9.52		20078	W	A		NBR
38.1	63.5	9.52		60505	W	B		NBR
38.1	63.5	9.52		59844	W	A	S	NBR
38.1	63.5	9.52		60680	W	B	S	NBR
				37674				
38.1	63.5	11.11			W	A		NBR
38.1	63.5	12.7		19948	W	A		NBR
38.1	63.5	12.7		60506	W	B		NBR
38.1	63.55	7.93		60681	W	B	S	NBR
38.1	65.08	7.93		60682	W	B	S	NBR
38.1	65.08	7.93		60507	W	B		NBR
38.1	65.08	12		40294	W	B	S	NBR
38.1	65.08	12		39537	W	A		NBR
38.1	66.67	9.52		59845	W	A	S	NBR
38.1	66.67	12.7		20079	W	A		NBR
38.1	69.85	9.52		59846	W	A	S	NBR
38.1	69.85	9.52		60243	W	A		NBR
38.1	69.85	12.7		20841	W	A		NBR
38.1	69.85	12.7		59847	W	A	S	NBR
38.1	73.02	11.11		35367	W	A		NBR
38.5	58	9		39538	W	A	S	NBR
38.5	58	11		39539	W	A	S	NBR
39	50.4	7		40295	W	B	S	NBR
39	50.5	7		55935	W	B	S	NBR
39	51	7.5		19132	W	A		NBR





油封

尺寸



d1	d2	H	H2	产品编码	产品组	设计型号	形式	材质
39	52	8		39540	W	A		NBR
39	52	10		63171	W	A	S	FKM
39	52	10		19806	W	A	S	NBR
39	55.5	9		40296	W	B		NBR
39	55.9	9		56708	W	A		NBR
39	58.8	4.8		40830	W	A	S	NBR
39	60	8		40829	W	A	S	NBR
39	64	9		39541	W	A	S	NBR
39	65	9		17511	W	A		NBR
39	65	9		63241	W	A		FKM
39.5	62	12		39542	W	A	S	NBR
39.68	52.38	4.76		59702	W	A		NBR
39.68	53.97	9.52		60508	W	B		NBR
39.68	57.15	7.93		44803	W	A		NBR
39.68	57.15	7.93		60510	W	B		NBR
39.68	57.15	9.52		60509	W	B		NBR
39.68	57.15	9.52		36779	W	C	S	NBR
39.68	57.15	9.52		20814	W	A		NBR
39.68	58.75	9.52		59699	W	A		NBR
39.68	58.75	9.52		59848	W	A	S	NBR
39.68	58.93	9.52		59849	W	A	S	NBR
39.68	60.32	9.52		36778	W	C	S	NBR
39.68	60.32	9.52		19943	W	A		NBR
39.68	60.32	9.52		59850	W	A	S	NBR
39.68	62	11.91		60244	W	B		NBR
39.68	62.5	12.7		24674	W	A		NBR
39.68	63.5	7.93		60684	W	B	S	NBR
39.68	63.5	7.93		20080	W	A		NBR
39.68	63.5	9.52		59852	W	A	S	NBR
39.68	63.5	9.52		59700	W	A		NBR
39.68	63.5	12.7		59851	W	A	S	NBR
39.68	63.5	12.7		60840	W	C		NBR
39.68	64.29	12.7		60839	W	C		NBR
39.68	66.67	9.52		20081	W	A		NBR
39.68	68.26	9.52		117747	W	A	S	NBR
39.68	68.26	9.52		36462	W	A		NBR
39.68	73.02	9.52		60685	W	B	S	NBR
39.68	73.13	7.93		60841	W	C		NBR
39.69	61.9	11.9		48729	W	C		NBR
39.69	63.5	12		75264	W	C		NBR
39.7	61.9	8		39543	W	A		NBR
39.7	62	11.5		39544	W	A	S	NBR
39.7	63.5	9		167196	W	A	S	NBR
39.7	80.4	15		36838	W	A		NBR
40	47	4		41431	W	B	S	NBR
40	47	4		22087	W	A	OK	NBR
40	47	4		162208	W	B	O	NBR
40	47	4		48957	W	A	OK	FKM
40	47	4		143411	W	B	O	NBR
40	47	5		46418	W	A	OK	NBR
40	48	3		41278	W	B	O	NBR
40	48	4		92834	W	A	OK	NBR
40	48	4		92267	W	B	O	FKM
40	48	4		34469	W	B	O	NBR
40	48	6		41279	W	B	O	NBR

Any seal. Any time.

www.dichtomatik.de



油封

尺寸

d1	d2	H	H2	产品编码	产品组	设计型号	形式	材质
40	50	4		22088	W	A	OK	NBR
40	50	4		41280	W	B	O	NBR
40	50	5		40831	W	A		NBR
40	50	5		39545	W	A	S	NBR
40	50	6		40490	W	B	O	NBR
40	50	6.5		19133	W	A	S	NBR
40	50	7		40384	W	C		NBR
40	50	7		19134	W	A		NBR
40	50	7		19135	W	A	S	NBR
40	50	7		104290	W	A		FKM
40	50	8		17512	W	A		NBR
40	50	8		19136	W	A	S	NBR
40	50	8		62909	W	A		FKM
40	50	9		40832	W	A		NBR
40	50.15	4		131120	W	A	O	NBR
40	51	5.5		40834	W	A		NBR
40	51	6		40833	W	A	S	NBR
40	51	10		40835	W	A	S	NBR
40	52	5		104291	W	A		FKM
40	52	5		19137	W	A	S	NBR
40	52	5		160731	W	B	O	NBR
40	52	5		48628	W	A	SY	FKM
40	52	5		24361	W	A		NBR
40	52	5		22089	W	A	OK	NBR
40	52	6		17513	W	A		NBR
40	52	6		56798	W	A		FKM
40	52	6		39546	W	A	S	NBR
40	52	7		19138	W	B	S	NBR
40	52	7		179374	W	A		NBR
40	52	7		56561	W	A	S	FKM
40	52	7		17515	W	A	S	NBR
40	52	7		116682	W	A		FKM
40	52	7		156461	W	A	O	NBR
40	52	7		17516	W	B		NBR
40	52	7		117597	W	A	SY	NBR
40	52	7		157253	W	A	SY	FKM
40	52	7		20346	W	A		FKM
40	52	7		17514	W	A		NBR
40	52	7		39060	W	C	S	NBR
40	52	7		76164	W	A	S	NBR
40	52	8		41732	W	C		NBR
40	52	8		19139	W	A		NBR
40	52	8		63172	W	A		FKM
40	52	8		19141	W	B		NBR
40	52	8		19140	W	A	S	NBR
40	52	8.5		39547	W	A		NBR
40	52	8.5		130958	W	A	S	NBR
40	52	9		63173	W	A	S	FKM
40	52	9		17517	W	A	S	NBR
40	52	10		63174	W	A		FKM
40	52	10		130576	W	A	S	FKM
40	52	10		39548	W	A	S	NBR
40	52	10		17518	W	A		NBR
40	52	11		129992	W	A	SY	NBR
40	53	7		40297	W	B	S	NBR





油封

尺寸



d1	d2	H	H2	产品编码	产品组	设计型号	形式	材质
40	53	7		150264	W	A	S	NBR
40	53	8.5		17519	W	A		NBR
40	54	5		40491	W	A	O	NBR
40	54	5.5		39549	W	A	S	NBR
40	54	5.5		19142	W	B	S	NBR
40	54	7		40298	W	B	S	NBR
40	54	7		35615	W	A		NBR
40	54	7		40492	W	A	O	NBR
40	54	7		39550	W	A	S	NBR
40	54	7.5		39551	W	A	S	NBR
40	54	11		41734	W	C	S	NBR
40	55	5		39018	W	A	O	NBR
40	55	6		22512	W	A	S	FKM
40	55	6		128171	W	A	SY	FKM
40	55	6		41733	W	B	O	NBR
40	55	6		36815	W	A	SY	NBR
40	55	6		40299	W	B	S	NBR
40	55	6.5		39552	W	A		NBR
40	55	7		40300	W	B	S	NBR
40	55	7		17520	W	A		NBR
40	55	7		17521	W	A	S	NBR
40	55	7		116375	W	A	SY	NBR
40	55	7		48630	W	A	SY	FKM
40	55	7		131075	W	A	S	FKM
40	55	7		22513	W	A	S	FKM
40	55	7		56697	W	A		FKM
40	55	7		17522	W	B		NBR
40	55	7		130836	W	A		FKM
40	55	7		152985	W	A	S	NBR
40	55	8		40301	W	B	S	NBR
40	55	8		20348	W	A	S	FKM
40	55	8		17525	W	B		NBR
40	55	8		60114	W	A	SY	FKM
40	55	8		17523	W	A		NBR
40	55	8		17524	W	A	S	NBR
40	55	8		20347	W	A		FKM
40	55	9		17526	W	C		NBR
40	55	9		19143	W	B	S	NBR
40	55	9		75069	W	A	S	NBR
40	55	10		17528	W	B		NBR
40	55	10		17527	W	A		NBR
40	55	10		17529	W	C		NBR
40	55	10		63188	W	A		FKM
40	55	10		60245	W	B		FKM
40	55	10		19144	W	A	S	NBR
40	55	10		36495	W	A		NBR
40	55	10		40836	W	A	O	NBR
40	55	12		38749	W	C	S	NBR
40	55	12		24431	W	B		NBR
40	55	12		39554	W	A		NBR
				19729				
40	55	12			W	C		NBR
40	55	12		39553	W	A	S	NBR
40	55.5	9		95575	W	B		NBR
40	56	6		157254	W	A	SY	FKM
40	56	7		40302	W	B	S	NBR

Any seal. Any time.



油封

尺寸

d1	d2	H	H2	产品编码	产品组	设计型号	形式	材质
40	56	7		104292	W	A		FKM
40	56	7		17530	W	B		NBR
40	56	7		27031	W	A		NBR
40	56	7		19145	W	A	S	NBR
40	56	8		39555	W	A	S	NBR
40	56	8		130764	W	A		FKM
40	56	8		22577	W	A		FKM
40	56	8		162935	W	A	S	FKM
40	56	8		17531	W	A		NBR
40	56	9		17532	W	C		NBR
40	56	9		130820	W	A		FKM
40	56	9		19146	W	A		NBR
40	56	10		17533	W	A		NBR
40	56	10		20349	W	A		FKM
40	56	10		39556	W	A	S	NBR
40	56	10		17534	W	B		NBR
40	56	10		17535	W	C		NBR
40	56	12		17537	W	C		NBR
40	56	12		17536	W	A		NBR
40	56	12		38545	W	A		FKM
40	57	10		39557	W	A	S	NBR
40	57.15	10		19147	W	B		NBR
40	57.15	10		44225	W	A		NBR
40	57.2	10		39558	W	A	S	NBR
40	58	6		40837	W	A	O	NBR
40	58	6		157403	W	A	SY	FKM
40	58	7		104294	W	A		FKM
40	58	7		26402	W	A		NBR
40	58	8		19148	W	A		NBR
40	58	8		75767	W	A	S	FKM
40	58	8		118696	W	A	SY	NBR
40	58	8		19149	W	A	S	NBR
40	58	8		104293	W	A		FKM
40	58	8.5		27534	W	A	S	NBR
40	58	8.5		90328	W	A	S	NBR
40	58	8.9		24416	W	A	S	NBR
40	58	9		57151	W	A		FKM
40	58	9		39559	W	A	S	NBR
40	58	9		19150	W	A		NBR
40	58	9		17538	W	B		NBR
40	58	9		19752	W	C		NBR
40	58	10		20465	W	A		FKM
40	58	10		17540	W	C		NBR
40	58	10		18705	W	A	S	NBR
40	58	10		19151	W	A		NBR
40	58	10		17539	W	B		NBR
40	58	12		17543	W	C		NBR
40	58	12		17541	W	A		NBR
40	58	12		17542	W	B		NBR
40	59	9.5		17544	W	A	S	NBR
40	59	9.5		63202	W	A	S	FKM
40	60	7		179886	W	A	SY	FKM
40	60	7		176072	W	A	S	NBR
40	60	7		17545	W	A		NBR
40	60	7		39560	W	A	S	NBR





油封

尺寸



d1	d2	H	H2	产品编码	产品组	设计型号	形式	材质
40	60	7		62521	W	A		FKM
40	60	7		151804	W	A	SY	NBR
40	60	8		19153	W	A		NBR
40	60	8		104295	W	A		FKM
40	60	8		37770	W	A	S	NBR
40	60	9		39561	W	A	S	NBR
40	60	10		38685	W	B	S	NBR
40	60	10		20350	W	A		FKM
40	60	10		84059	W	A	SY	NBR
40	60	10		160859	W	A		NBR
40	60	10		157255	W	A	SY	FKM
40	60	10		38748	W	C	S	NBR
40	60	10		19154	W	A	S	NBR
40	60	10		17546	W	A		NBR
40	60	10		17547	W	B		NBR
40	60	10		84822	W	A	S	FKM
40	60	10		17548	W	C		NBR
40	60	12		104296	W	A		FKM
40	60	12		40303	W	B	S	NBR
40	60	12		44246	W	A		NBR
40	60	12		24267	W	B		NBR
40	60	12		17549	W	C		NBR
40	60	12		19155	W	A	S	NBR
40	61	10		40838	W	A		NBR
40	62	5		40769	W	A		NBR
40	62	5		40493	W	A	O	NBR
40	62	6		48634	W	A	SY	FKM
40	62	6		78452	W	A	SY	NBR
40	62	6.5		40840	W	A		NBR
40	62	7		19730	W	B		NBR
40	62	7		130805	W	A		FKM
40	62	7		20351	W	A		FKM
40	62	7		18640	W	B	S	NBR
40	62	7		171299	W	A	S	FKM
40	62	7		20775	W	A	S	FKM
40	62	7		17550	W	A		NBR
40	62	7		39562	W	A	S	NBR
40	62	8		104297	W	A		FKM
40	62	8		17551	W	C		NBR
40	62	8		41735	W	B		NBR
40	62	8		44268	W	A		NBR
40	62	8		19157	W	A	S	NBR
40	62	8		40304	W	B	S	NBR
40	62	9		19158	W	A	S	NBR
40	62	9		17552	W	C		NBR
40	62	10		17555	W	B		NBR
40	62	10		17556	W	C		NBR
40	62	10		17554	W	A	S	NBR
40	62	10		20352	W	A		FKM
40	62	10		17553	W	A		NBR
40	62	10		39355	W	B	S	NBR
40	62	10		38948	W	A	S	FKM
40	62	10		17557	W	C	S	NBR
40	62	11		41736	W	B	S	NBR
40	62	11		19159	W	A	S	NBR

Any seal. Any time.

www.dichtomatik.de



油封

尺寸

d1	d2	H	H2	产品编码	产品组	设计型号	形式	材质
40	62	11		134218	W	A	SY	NBR
40	62	11		41737	W	B		NBR
40	62	11.5		17558	W	A		NBR
40	62	11.5		19160	W	A	S	NBR
40	62	12		17561	W	C		NBR
40	62	12		17559	W	A		NBR
40	62	12		63230	W	A		FKM
40	62	12		18639	W	B	S	NBR
40	62	12		19161	W	A	S	NBR
40	62	12		17560	W	B		NBR
40	62	12		48635	W	A	S	FKM
40	62	14		40841	W	A	S	NBR
40	62	14		118562	W	A		NBR
40	63	6		40842	W	A		NBR
40	63	7		19156	W	A	S	NBR
40	63	10		38440	W	A		NBR
40	63.5	12.5		38484	W	C		NBR
40	63.6	12.7		37310	W	A		NBR
40	64	10		39563	W	A	S	NBR
40	64	12		81239	W	A	S	NBR
40	65	8		39564	W	A	S	NBR
40	65	9		24366	W	A		NBR
40	65	9		39565	W	A	S	NBR
40	65	9		17562	W	B		NBR
40	65	10		20353	W	A		FKM
40	65	10		40305	W	B	S	NBR
40	65	10		17565	W	B		NBR
40	65	10		17564	W	A	S	NBR
40	65	10		17566	W	C		NBR
40	65	10		60690	W	A	S	FKM
40	65	10		17563	W	A		NBR
40	65	10		61343	W	C	S	NBR
40	65	12		17568	W	B		NBR
40	65	12		17570	W	C		NBR
40	65	12		19162	W	A	S	NBR
40	65	12		63242	W	A		FKM
40	65	12		75825	W	A	S	FKM
40	65	12		17567	W	A		NBR
40	65	12		17569	W	B	S	NBR
40	65	12		17571	W	C	S	NBR
40	65	13		19163	W	A	S	NBR
40	65	14		19164	W	A	S	NBR
40	67	8		19165	W	A	S	NBR
40	67	8		22168	W	B		NBR
40	68	6		26938	W	A		NBR
40	68	7		17572	W	B		NBR
40	68	7		39567	W	A		NBR
40	68	7		39566	W	A	S	NBR
40	68	7.2		165316	W	A	S	NBR
40	68	8		83420	W	A		NBR
40	68	10		20354	W	A		FKM
40	68	10		38652	W	B		NBR
40	68	10		39255	W	A	S	NBR
40	68	10		56799	W	A	S	FKM
40	68	10		17573	W	A		NBR





油封

尺寸



d1	d2	H	H2	产品编码	产品组	设计型号	形式	材质
40	68	10		17574	W	C		NBR
40	68	11		17575	W	A		NBR
40	68	11		63259	W	A		FKM
40	68	11		39568	W	A	S	NBR
40	68	11		40306	W	B	S	NBR
40	68	12		19166	W	A		NBR
40	68	12		17576	W	C		NBR
40	68	12		39569	W	A	S	NBR
40	68	12		40307	W	B		NBR
40	68	12		104298	W	A		FKM
40	69	9		40839	W	A	S	NBR
40	70	8		104300	W	A		FKM
40	70	8		19167	W	A	S	NBR
40	70	8		27033	W	A		NBR
40	70	10		17578	W	B		NBR
40	70	10		17577	W	A		NBR
40	70	10		17579	W	C		NBR
40	70	10		35081	W	A	S	NBR
40	70	10		63269	W	A		FKM
40	70	12		26403	W	A		NBR
40	70	12		17580	W	C		NBR
40	70	12		104299	W	A		FKM
40	72	7		39570	W	A	S	NBR
40	72	7		22578	W	A		FKM
40	72	7		128176	W	A	SY	NBR
40	72	7		17581	W	A		NBR
40	72	7		48637	W	A	S	FKM
40	72	7		17582	W	B		NBR
40	72	7		128169	W	A	SY	FKM
40	72	8		40843	W	A	S	NBR
40	72	9		17583	W	B		NBR
40	72	9		17584	W	C		NBR
40	72	10		20355	W	A		FKM
40	72	10		17585	W	A		NBR
40	72	10		17586	W	B		NBR
40	72	10		171695	W	A	S	NBR
40	72	10		73229	W	A	S	FKM
40	72	10		17587	W	C		NBR
40	72	10		19168	W	A	S	NBR
40	72	10		40385	W	C	S	NBR
40	72	12		39571	W	A	S	NBR
40	72	12		17589	W	C		NBR
40	72	12		17588	W	B		NBR
40	72	12		19169	W	A		NBR
40	72	12		104301	W	A		FKM
40	72.5	11.5		40844	W	A	S	NBR
40	75	7		38632	W	A		NBR
40	75	10		39588	W	A	S	NBR
40	75	12		39589	W	A	S	NBR
40	78	10		24192	W	A		NBR
40	78	10		25723	W	C		NBR
40	78	10		104302	W	A		FKM
40	80	7		179962	W	A		FKM
40	80	7		40845	W	A	S	NBR
40	80	7		27979	W	A		NBR

Any seal. Any time.



油封

尺寸

d1	d2	H	H2	产品编码	产品组	设计型号	形式	材质
40	80	8		19170	W	A		NBR
40	80	8		104303	W	A		FKM
40	80	8		39590	W	A	S	NBR
40	80	10		22579	W	A		FKM
40	80	10		161676	W	A		NBR
40	80	10		17590	W	A		NBR
40	80	10		17593	W	C		NBR
40	80	10		26199	W	A	S	NBR
40	80	10		179361	W	A	S	FKM
40	80	10		179362	W	A	S	FKM
40	80	10		17591	W	B		NBR
40	80	10		17592	W	B	S	NBR
40	80	10		73230	W	A	S	FKM
40	80	12		17595	W	B		NBR
40	80	12		27389	W	A		NBR
40	80	12		17594	W	A	S	NBR
40	80	12		63304	W	A	S	FKM
40	80	13		63305	W	A		FKM
40	80	13		19725	W	B		NBR
40	80	13		34803	W	A	S	NBR
40	80	13		17598	W	C		NBR
40	80	13		38750	W	C	S	NBR
40	80	13		17597	W	A		NBR
40	82.57	13		75265	W	C		NBR
40	85	10		20745	W	A		FKM
40	85	10		19171	W	A		NBR
40	85	10		127620	W	A	S	FKM
40	85	10		38731	W	C		NBR
40	85	10		122333	W	A	S	NBR
40	90	8		73079	W	C		NBR
40	90	8		127628	W	A	S	NBR
40	90	8		69820	W	A		NBR
40	90	9		39591	W	A	S	NBR
40	90	9		60251	W	C		NBR
40	90	10		39592	W	A	S	NBR
40	90	10		36995	W	A		NBR
40	90	10		175454	W	A		NBR
40	90	12		56800	W	A	S	FKM
40	90	12		39594	W	A	S	NBR
40	90	12		17599	W	B		NBR
40	90	12		39593	W	A		NBR
40	90	12		17600	W	C		NBR
40	90	13		17601	W	C		NBR
40	95	10		48730	W	C		NBR
40	110	10		122036	W	A	S	NBR
40	110	12		72975	W	A		NBR
40.08	50.85	4.1		39019	W	A	O	NBR
40.08	50.85	4.1		83419	W	A		NBR
40.49	58.75	9.52		59853	W	A	S	NBR
41	47	4		40846	W	A	O	NBR
41	52	5.5		41738	W	B	O	NBR
41	52	7		39595	W	A	S	NBR
41	52	8		81139	W	A		NBR
41	53	7		19173	W	A	S	NBR
41	53	7		40386	W	C	S	NBR





油封

尺寸



d1	d2	H	H2	产品编码	产品组	设计型号	形式	材质
41	53	7		18497	W	B	S	NBR
41	53	8		39596	W	A	S	NBR
41	55	6		40308	W	B	S	NBR
41	55	7		39597	W	A	S	NBR
41	55	8.5		19172	W	A		NBR
41	55	9		39598	W	A	S	NBR
41	55	9		40309	W	B	S	NBR
41	56	7		40310	W	B		NBR
41	56	7		19174	W	A		NBR
41	56	7		39599	W	A	S	NBR
41	56	7.4		19175	W	A		NBR
41	56	8		19176	W	A		NBR
41	56	8		19177	W	A	S	NBR
41	56	9		19178	W	B	S	NBR
41	56	10		17602	W	A		NBR
41	56	10		19179	W	A	S	NBR
41	56	10		17603	W	B		NBR
41	60	10		41739	W	B	S	NBR
41	60.3	6.5		41740	W	B		NBR
41	60.5	8		41741	W	C		NBR
41	63	6		40847	W	A		NBR
41	63.5	10		40848	W	A		NBR
41.27	50.8	6.35		60511	W	B		NBR
41.27	50.8	6.35		37749	W	A	O	NBR
41.27	50.8	12.7		59703	W	A		NBR
41.27	52.38	6.98		72916	W	B		NBR
41.27	53.97	6.35		60512	W	B		NBR
41.27	53.97	6.35		20082	W	A		NBR
41.27	53.97	6.35		134029	W	A	S	FKM
41.27	55.56	9.52		20083	W	A		NBR
41.27	57.15	7.93		39195	W	A	S	NBR
41.27	57.15	7.93		60686	W	B	S	NBR
41.27	57.15	9.52		59854	W	A	S	NBR
41.27	57.15	9.52		20084	W	A		NBR
41.27	60.32	7.93		19944	W	A		NBR
41.27	60.32	7.93		60687	W	B	S	NBR
41.27	60.32	7.93		60513	W	B		NBR
41.27	60.32	9.52		134032	W	A	S	FKM
41.27	60.32	9.52		60688	W	B	S	NBR
41.27	60.32	9.52		20085	W	A		NBR
41.27	60.32	9.52		21956	W	A	S	NBR
41.27	60.32	12.7		20086	W	A		NBR
41.27	60.32	12.7		60842	W	C		NBR
41.27	60.4	9.25		60253	W	B		NBR
41.27	61.91	7.93		60689	W	B	S	NBR
41.27	61.91	9.52		26431	W	B		NBR
41.27	61.91	12.7		20246	W	A		NBR
41.27	63.5	7.93		20087	W	A		NBR
41.27	63.5	7.93		60691	W	B	S	NBR
41.27	63.5	7.93		60514	W	B		NBR
41.27	63.5	9.52		60692	W	B	S	NBR
41.27	63.5	9.52		20088	W	A		NBR
41.27	63.5	9.52		59855	W	A	S	NBR
41.27	63.5	12.7		19949	W	A		NBR
41.27	63.5	12.7		59508	W	A	S	NBR

Any seal. Any time.

www.dichtomatik.de



油封

尺寸

d1	d2	H	H2	产品编码	产品组	设计型号	形式	材质
41.27	63.5	12.7		60515	W	B		NBR
41.27	63.65	7.95		48731	W	C		NBR
41.27	65.08	9.52		60516	W	B		NBR
41.27	65.08	9.52		20838	W	A		NBR
41.27	66.67	9.52		59856	W	A	S	NBR
41.27	66.67	9.52		20089	W	A		NBR
41.27	66.67	12.7		20090	W	A		NBR
41.27	66.67	12.7		36645	W	C		NBR
41.27	66.67	12.7		40311	W	B	S	NBR
41.27	68.26	12.7		72954	W	A		NBR
41.27	69.85	9.52		20091	W	A		NBR
41.27	69.85	12.7		20092	W	A		NBR
41.27	73.02	7.93		60517	W	B		NBR
41.27	73.02	7.93		35552	W	A		NBR
41.27	73.02	12.7		60518	W	B		NBR
41.27	73.02	12.7		20842	W	A		NBR
41.5	49	4		152706	W	B	O	NBR
41.53	63.5	7.93		60844	W	C		NBR
41.7	55	8		39600	W	A	S	NBR
42	47	6		41743	W	B	O	NBR
42	50	7		19801	W	A		NBR
42	50	7		62910	W	A		FKM
42	50	10		40849	W	A	O	NBR
42	50	10		60217	W	A		NBR
42	52	4		19180	W	A	S	NBR
42	52	4		22090	W	A	OK	NBR
42	52	5		146084	W	B	O	FKM
42	52	5		88988	W	A		NBR
42	52	5		131098	W	A	O	NBR
42	52	5.5		81261	W	A	O	NBR
42	52	8		39198	W	A		NBR
42	52	8		19181	W	A	S	NBR
42	52	8		121811	W	A		FKM
42	52	9.5		163722	W	A		NBR
42	52	10		20660	W	B		NBR
42	52.5	7		39601	W	A		NBR
42	53	7		39602	W	A	S	NBR
42	54	5		39603	W	A	S	NBR
42	55	5		39604	W	A	S	NBR
42	55	6		39605	W	A	S	NBR
42	55	6		177551	W	A		FKM
42	55	6		40312	W	B	S	NBR
42	55	7		19182	W	A	S	NBR
42	55	7		17604	W	A		NBR
42	55	7		17605	W	B		NBR
42	55	7		77493	W	A	S	FKM
42	55	7		40313	W	B	S	NBR
42	55	7		62645	W	A		FKM
42	55	8		55911	W	A		NBR
42	55	8		19183	W	A	S	NBR
42	55	8		38062	W	B		NBR
42	55	8		17606	W	A		NBR
42	55	8		35882	W	A		FKM
42	55	8		62522	W	A	S	FKM
45	72	12		174274	W	B	SY	FKM





油封

尺寸



d1	d2	H	H2	产品编码	产品组	设计型号	形式	材质
42	55	9		19184	W	A	S	NBR
42	55	9		40850	W	A		NBR
42	55	9		75063	W	A	S	FKM
42	55	9		40314	W	B		NBR
42	55	9		18641	W	B	S	NBR
42	55	10		19187	W	B	S	NBR
42	55	10		104304	W	A		FKM
42	55	10		19185	W	A		NBR
42	55	10		19186	W	A	S	NBR
42	55	12		40851	W	A	S	NBR
42	56	5		39606	W	A		NBR
42	56	6		19188	W	A		NBR
42	56	7		17608	W	B		NBR
42	56	7		20356	W	A		FKM
42	56	7		17607	W	A		NBR
42	56	7		34869	W	A	S	NBR
42	56	7		148478	W	A		FKM
42	56	7		48638	W	A	S	FKM
42	56	7		19189	W	B	S	NBR
42	56	8		40315	W	B		NBR
42	56	10		19191	W	B	S	NBR
42	56	10		19190	W	A	S	NBR
42	57	7		39203	W	A		NBR
42	57	8		19192	W	B	S	NBR
42	57	14		40852	W	A	S	NBR
42	57.15	10		19193	W	B		NBR
42	58	7		75064	W	A		NBR
42	58	7		19195	W	B		NBR
42	58	7		17609	W	B	S	NBR
42	58	7		19194	W	A	S	NBR
42	58	8		19196	W	A	S	NBR
42	58	8		72520	W	A		NBR
42	58	9		17610	W	B		NBR
42	58	10		17611	W	A		NBR
42	58	10		63199	W	A		FKM
42	58	10		39607	W	A	S	NBR
42	58	10		17612	W	B		NBR
42	58	12		17613	W	A		NBR
42	58.5	10		40853	W	A		NBR
42	60	7		19197	W	A	S	NBR
42	60	7		104346	W	A	S	FKM
42	60	7		40854	W	A		NBR
42	60	7		41742	W	B	O	NBR
42	60	8		19198	W	A		NBR
42	60	8		104305	W	A		FKM
42	60	8		39608	W	A	S	NBR
42	60	9		19199	W	A		NBR
42	60	9		19200	W	A	S	NBR
42	60	9		19201	W	B		NBR
42	60	10		17614	W	A		NBR
42	60	10		17615	W	B		NBR
42	60	10		19202	W	A	S	NBR
42	60	10		17616	W	C		NBR
42	60	10		44553	W	A		FKM
42	60	12		40855	W	A		NBR

Any seal. Any time.

www.dichtomatik.de



油封

尺寸

d1	d2	H	H2	产品编码	产品组	设计型号	形式	材质
42	60	12		22580	W	A		FKM
42	60	12		17617	W	C		NBR
42	62	7		22581	W	A		FKM
42	62	7		21584	W	A		NBR
42	62	7		17619	W	B		NBR
42	62	7		63231	W	A	S	FKM
42	62	7		17620	W	B	S	NBR
42	62	7		128172	W	A	SY	FKM
42	62	7		118697	W	A	SY	NBR
42	62	7		17618	W	A	S	NBR
42	62	8		19203	W	A		NBR
42	62	8		157301	W	A	SY	NBR
42	62	8		48639	W	A	SY	FKM
42	62	8		37439	W	A		FKM
42	62	8		38639	W	A	S	NBR
42	62	8		40316	W	B		NBR
42	62	8		56801	W	A	S	FKM
42	62	9		39609	W	A	S	NBR
42	62	10		17621	W	A		NBR
42	62	10		17623	W	C		NBR
42	62	10		17622	W	B		NBR
42	62	10		38686	W	B	S	NBR
42	62	10		19204	W	A	S	NBR
42	62	10		20357	W	A		FKM
42	62	11		39610	W	A	S	NBR
42	62	12		63232	W	A		FKM
42	62	12		17624	W	A		NBR
42	62	12		17625	W	B		NBR
42	62	12		17626	W	C		NBR
42	63	7		60216	W	B		NBR
42	64	7		19205	W	A		NBR
42	65	8		19206	W	A		NBR
42	65	8		179225	W	B		FKM
42	65	8		83467	W	C		NBR
42	65	8		39611	W	A	S	NBR
42	65	8		104343	W	A		FKM
42	65	9		39612	W	A	S	NBR
42	65	9		40317	W	B	S	NBR
42	65	10		39182	W	A	S	NBR
42	65	10		17628	W	B		NBR
42	65	10		130744	W	A		FKM
42	65	10		17627	W	A		NBR
42	65	10		17629	W	C		NBR
42	65	10		20358	W	A		FKM
42	65	12		19207	W	A	S	NBR
42	65	12		63243	W	A		FKM
42	65	12		17632	W	C		NBR
42	65	12		17630	W	A		NBR
42	65	12		17631	W	B		NBR
42	65	12		129993	W	A	SY	NBR
42	65	13		40318	W	B	S	NBR
42	65	13		77726	W	A	S	NBR
42	67	10		60213	W	A	S	NBR
42	67	10		41745	W	B		NBR
42	68	8		62523	W	A		FKM





油封

尺寸



d1	d2	H	H2	产品编码	产品组	设计型号	形式	材质
42	68	10		17633	W	A	S	NBR
42	68	11		44230	W	A		NBR
42	68	11.5		63260	W	A		FKM
42	68	11.5		17634	W	A		NBR
42	68	12		40856	W	A	S	NBR
42	70	8		39613	W	A		NBR
42	70	10		17636	W	C		NBR
42	70	10		19209	W	A	S	NBR
42	70	10		17635	W	B		NBR
42	70	10		19208	W	A		NBR
42	70	12		39614	W	A	S	NBR
42	70	12		17637	W	A		NBR
42	70	12		38730	W	C		NBR
42	72	6		48536	W	A	S	NBR
42	72	8		62524	W	A		FKM
42	72	8		19210	W	A		NBR
42	72	8		39615	W	A	S	NBR
42	72	9		81936	W	A	S	NBR
42	72	10		19211	W	A	S	NBR
42	72	10		40319	W	B	S	NBR
42	72	10		17638	W	A		NBR
42	72	10		25635	W	A		FKM
42	72	10		17639	W	B		NBR
42	72	10		17640	W	C		NBR
42	72	12		17642	W	C		NBR
42	72	12		104306	W	A		FKM
42	72	12		39616	W	A		NBR
42	72	12		17641	W	B		NBR
42	72.5	12		39617	W	A	S	NBR
42	72.5	12		40320	W	B	S	NBR
42	75	10		39618	W	A	S	NBR
42	75	12		69295	W	A	S	NBR
42	76	12		19212	W	A	S	NBR
42	80	10		179757	W	A	S	NBR
42	80	10		17643	W	A		NBR
42	80	10		63306	W	A		FKM
42	80	12		17644	W	C		NBR
42	80	13		17645	W	C		NBR
42	81	13		19822	W	A		NBR
42	81	13		63318	W	A		FKM
42.4	55	7		19846	W	B		NBR
42.67	76.2	9.65		92203	W	C		NBR
42.77	65.08	13.08		60519	W	B		NBR
42.86	57.15	7.93		21522	W	A		NBR
42.86	57.15	7.93		39196	W	A	S	NBR
42.86	59.13	7.93		60694	W	B	S	NBR
42.86	59.13	12.7		127689	W	B	O	NBR
42.86	62.23	8.99		60695	W	B	S	NBR
42.86	63.5	9.52		20093	W	A		NBR
42.86	63.5	9.52		177537	W	A		NBR
42.86	63.5	12.7		19950	W	A		NBR
42.86	66.62	9.52		60763	W	B	O	NBR
42.86	68.26	12.7		20247	W	A		NBR
42.86	69.85	9.52		107898	W	B	S	NBR
42.86	69.85	9.52		59857	W	A	S	NBR

Any seal. Any time.



油封

尺寸

d1	d2	H	H2	产品编码	产品组	设计型号	形式	材质
42.86	76.2	12.7		35309	W	A		NBR
43	53	4		110707	W	B	O	NBR
43	53	4		22091	W	A	OK	NBR
43	53	5		19213	W	A		NBR
43	54	7		39619	W	A	S	NBR
43	54	7.5		55936	W	B	S	NBR
43	54	7.5		39620	W	A	S	NBR
43	54	7.5		40857	W	A		NBR
43	54	9		7179	W	A	S	NBR
43	54.99	7.01		59858	W	A	S	NBR
43	55	7		19214	W	A		NBR
43	55	8		39621	W	A	S	NBR
43	55	9		5941	W	A	S	NBR
43	58	6.7		35511	W	B		NBR
43	58	7		19215	W	A	S	NBR
43	59	5		40858	W	A		NBR
43	59	8		40859	W	A	S	NBR
43	60	10		63206	W	A		FKM
43	60	10		72615	W	A		NBR
43	61	9		40321	W	B	S	NBR
43	61	9		40322	W	B		NBR
43	62	8		39622	W	A	S	NBR
43	62	10		63233	W	A		FKM
43	62	10		17646	W	A		NBR
43	62	12		19216	W	A	S	NBR
43	65	8		60210	W	A		NBR
43	65	13		63244	W	A		FKM
43	66	10		39623	W	A	S	NBR
43	66	10		17648	W	A		NBR
43	66	10		63250	W	A		FKM
43	66	12		63251	W	A		FKM
43	66	12		17649	W	A		NBR
43	68	12		40860	W	A	S	NBR
43	70	10		40861	W	A	S	NBR
43	70	12		22582	W	A		FKM
43	72	10		40387	W	C		NBR
43	73	10		39624	W	A	S	NBR
43	75	10		38633	W	A		NBR
43	80	10		63307	W	A		FKM
43	80	10		17650	W	A		NBR
43.26	61.11	9.52		59704	W	A		NBR
43.26	78.13	12.7		60520	W	B		NBR
43.5	68	12		40862	W	A	S	NBR
43.66	60.32	9.52		81271	W	A	S	NBR
43.66	65.08	12.7		60696	W	B	S	NBR
43.66	65.08	12.7		60764	W	B	O	NBR
44	52	10		26513	W	A	O	NBR
44	52	10		26404	W	A		NBR
44	54	4.5		39625	W	A	S	NBR
44	54	4.5		63179	W	A		FKM
44	54	4.5		19845	W	A		NBR
44	54	7		39626	W	A	S	NBR
44	54	7.5		39629	W	A		NBR
44	55	5		40867	W	A	O	NBR
44	55	7		179531	W	A	S	NBR





油封

尺寸



d1	d2	H	H2	产品编码	产品组	设计型号	形式	材质
44	55	7		75998	W	A		FKM
44	55	7		26405	W	A		NBR
44	56	7		19217	W	B		NBR
44	58	7		35471	W	B		NBR
44	58	9		40863	W	A	S	NBR
44	58	10		63200	W	A		FKM
44	58.2	7		49539	W	B		NBR
44	58.3	9		40864	W	A	S	NBR
44	58.5	10		40865	W	A		NBR
44	60	6		41744	W	B		NBR
44	60	7		39627	W	A	S	NBR
44	60	7		40323	W	B	S	NBR
44	60	9		19219	W	A	S	NBR
44	60	9		19218	W	A		NBR
44	60	10		19220	W	B		NBR
44	60	10		38729	W	C		NBR
44	60	10		63207	W	A		FKM
44	60	10		39628	W	A	S	NBR
44	60	10		17651	W	A		NBR
44	60	12		19221	W	A	S	NBR
44	61	8		19222	W	A	S	NBR
44	61	10		40866	W	A	S	NBR
44	62	8		19223	W	A	S	NBR
44	62	8		40868	W	A		NBR
44	62	9		19224	W	A	S	NBR
44	62	10		19225	W	A		NBR
44	62	10		63234	W	A	S	FKM
44	62	10		104307	W	A		FKM
44	62	10		19226	W	B		NBR
44	62	10		17652	W	A	S	NBR
44	62	11.5		19227	W	A	S	NBR
44	62	12		19228	W	B		NBR
44	62	12		17653	W	C		NBR
44	63.5	11		40869	W	A		NBR
44	64	9		81249	W	A	S	NBR
44	65	8		39630	W	A	S	NBR
44	65	8		62525	W	A		FKM
44	65	10		19230	W	B	S	NBR
44	65	10		40324	W	B		NBR
44	65	10		17654	W	A		NBR
44	65	10		20359	W	A		FKM
44	65	11		38640	W	A	S	NBR
44	65	12		39061	W	C		NBR
44	66	13		40872	W	A		NBR
44	69	11		40871	W	A	S	NBR
44	70	10		62968	W	A		NBR
44	70	12		38728	W	C		NBR
44	70	12		40873	W	A	S	NBR
44	72	10		130766	W	A		FKM
44	72	10		17655	W	A		NBR
44	72	10		63286	W	A		FKM
44	72	12		25724	W	C		NBR
44	73	12		63293	W	A		FKM
44	73	12		17656	W	A		NBR
44	78	12		81250	W	A		NBR

Any seal. Any time.

www.dichtomatik.de



油封

尺寸

d1	d2	H	H2	产品编码	产品组	设计型号	形式	材质
44	100	12		39631	W	A		NBR
44.45	53.97	4.76		19933	W	A		NBR
44.45	57.15	6.35		124952	W	B	O	NBR
44.45	57.15	7.93		20094	W	A		NBR
44.45	57.15	9.52		59859	W	A	S	NBR
44.45	57.15	9.52		19941	W	A		NBR
44.45	57.15	9.52		60697	W	B	S	NBR
44.45	57.15	12.7		20095	W	A		NBR
44.45	57.15	12.7		75800	W	B	O	NBR
44.45	57.15	12.7		60698	W	B	S	NBR
44.45	58.73	6.35		59860	W	A	S	NBR
44.45	58.73	6.35		60521	W	B		NBR
44.45	58.73	6.35		19942	W	A		NBR
44.45	60.32	7.93		19945	W	A		NBR
44.45	60.32	9.52		60699	W	B	S	NBR
44.45	60.32	9.52		20096	W	A		NBR
44.45	60.32	9.52		60522	W	B		NBR
44.45	60.32	9.52		22626	W	A	S	NBR
44.45	60.32	12.7		20097	W	A		NBR
44.45	60.53	9.52		35512	W	A	S	NBR
44.45	61.91	7.93		20836	W	A		NBR
44.45	61.91	7.93		120894	W	A		FKM
44.45	61.91	7.93		60523	W	B		NBR
44.45	61.91	9.52		26430	W	B		NBR
44.45	63.5	7.93		19951	W	A		NBR
44.45	63.5	7.93		59861	W	A	S	NBR
44.45	63.5	7.93		60524	W	B		NBR
44.45	63.5	9.52		81669	W	B	S	NBR
44.45	63.5	9.52		40389	W	C		NBR
44.45	63.5	9.52		38148	W	A		FKM
44.45	63.5	9.52		59862	W	A	S	NBR
44.45	63.5	9.52		19986	W	A		NBR
44.45	63.5	12.7		60525	W	B		NBR
44.45	63.5	12.7		36776	W	C	S	NBR
44.45	63.5	12.7		26354	W	A		FKM
44.45	63.5	12.7		19952	W	A		NBR
44.45	63.5	12.7		117748	W	A	S	NBR
44.45	63.5	13.09		157004	W	B	S	NBR
44.45	65	10		40325	W	B	S	NBR
44.45	65.08	7.93		74038	W	A		NBR
44.45	65.08	7.93		60526	W	B		NBR
44.45	65.08	7.93		60700	W	B	S	NBR
44.45	66.67	9.52		20098	W	A		NBR
44.45	66.67	9.52		59863	W	A	S	NBR
44.45	66.67	12.7		36777	W	C	S	NBR
44.45	66.67	12.7		20099	W	A		NBR
44.45	68.26	11.11		59705	W	A		NBR
44.45	68.26	12.7		35072	W	A		NBR
44.45	68.33	12.7		40388	W	C		NBR
44.45	68.99	9.12		60765	W	B	O	NBR
44.45	69.1	12.7		72738	W	A		NBR
44.45	69.85	7.93		60527	W	B		NBR
44.45	69.85	7.93		60701	W	B	S	NBR
44.45	69.85	9.52		19957	W	A		NBR
44.45	69.85	9.52		22180	W	A	S	NBR





油封

尺寸



d1	d2	H	H2	产品编码	产品组	设计型号	形式	材质
44.45	69.85	12.7		41746	W	B	S	NBR
44.45	69.85	12.7		60528	W	B		NBR
44.45	69.85	12.7		59864	W	A	S	NBR
44.45	69.85	12.7		20100	W	A		NBR
44.45	70.15	9.52		76506	W	B	S	NBR
44.45	71.12	9.52		60529	W	B		NBR
44.45	71.38	7.93		60702	W	B	S	NBR
44.45	73.02	9.52		60530	W	B		NBR
44.45	73.02	9.52		20101	W	A		NBR
44.45	73.02	9.52		59865	W	A	S	NBR
44.45	73.02	12.7		20102	W	A		NBR
44.45	73.02	12.7		41748	W	B		NBR
44.45	76.2	9.52		20103	W	A		NBR
44.45	76.2	9.52		59866	W	A	S	NBR
44.45	76.2	9.53		48733	W	C		NBR
44.45	76.2	12.7		41747	W	B	S	NBR
44.45	80.96	7.93		60531	W	B		NBR
44.45	80.96	12.7		20816	W	A		NBR
44.5	60.43	9.25		60209	W	C		NBR
44.5	62	10		19609	W	A		NBR
44.5	62	10		19690	W	A	S	NBR
44.5	62	11.5		19231	W	A		NBR
44.5	70	10		40326	W	B	S	NBR
44.5	70	10		39632	W	A	S	NBR
44.65	60.32	6.35		48640	W	A		FKM
45	50	3		19779	W	B	O	NBR
45	50	5		65119	W	A		NBR
45	52	3		121261	W	B	O	NBR
45	52	4		79602	W	B	O	NBR
45	52	4		176951	W	A	OK	NBR
45	52	4		162213	W	B	O	NBR
45	52	4		22092	W	A	OK	NBR
45	52	4		115165	W	A	OK	FKM
45	52	8		19232	W	A		NBR
45	54	4.5		39633	W	A	S	NBR
45	54	6.35		41749	W	B		NBR
45	55	4		22093	W	A	OK	NBR
45	55	4		56802	W	A	O	FKM
45	55	5		41751	W	B	O	NBR
45	55	6		40494	W	B	O	NBR
45	55	7		46620	W	A	SY	NBR
45	55	7		143525	W	A	S	FKM
45	55	7		38441	W	A		NBR
45	55	7		18478	W	B		NBR
45	55	7		157256	W	A	SY	FKM
45	55	7		20504	W	A		FKM
45	55	7		75031	W	A	S	NBR
45	55	8		19233	W	A		NBR
45	55	8		104308	W	A		FKM
45	55	8		163569	W	A		NBR
45	55	8		41750	W	B		NBR
45	55	10		39634	W	A		NBR
45	56	6		39635	W	A		NBR
45	56	7		39637	W	A	S	NBR
45	56	7		7353	W	A		NBR

Any seal. Any time.

www.dichtomatik.de



油封

尺寸

d1	d2	H	H2	产品编码	产品组	设计型号	形式	材质
45	56	7		104345	W	A	S	FKM
45	57	4		41753	W	B		NBR
45	57	4		41752	W	B	O	NBR
45	57	5.5		19234	W	A	S	NBR
45	57	7		19235	W	A		NBR
45	57	7		40875	W	A	S	NBR
45	57	7.5		19236	W	A	S	NBR
45	57	7.5		39638	W	A		NBR
45	57	10		46806	W	A	S	NBR
45	58	6		120968	W	A	SY	NBR
45	58	6		176789	W	A	SY	NBR
45	58	7		157257	W	A	SY	FKM
45	58	7		118698	W	A	SY	NBR
45	58	7		38641	W	A	S	NBR
45	58	7		17657	W	A		NBR
45	58	7		63201	W	A	S	FKM
45	58	8		19237	W	A		NBR
45	58	9		81235	W	B		NBR
45	58	9		40327	W	B	S	NBR
45	58	12		39639	W	A	S	NBR
45	59	8		26406	W	A		NBR
45	59	10		39643	W	A	S	NBR
45	59.13	10		19238	W	B		NBR
45	59.13	10		39640	W	A	S	NBR
45	60	5		40877	W	A	S	NBR
45	60	6		40495	W	A	O	NBR
45	60	6.5		39641	W	A		NBR
45	60	6.5		174552	W	B	O	NBR
45	60	7		20360	W	A		FKM
45	60	7		63208	W	A	S	FKM
45	60	7		44744	W	B		FKM
45	60	7		17659	W	A	S	NBR
45	60	7		19694	W	B		NBR
45	60	7		130988	W	A	S	FKM
45	60	7		160495	W	A		NBR
45	60	7		17658	W	A		NBR
45	60	8		17661	W	B		NBR
45	60	8		18661	W	A	S	NBR
45	60	8		62526	W	A	S	FKM
45	60	8		121610	W	A		NBR
45	60	8		44088	W	A		FKM
45	60	8		131061	W	A	S	FKM
45	60	8		17660	W	A		NBR
45	60	9		42068	W	B		NBR
45	60	9		19240	W	A	S	NBR
45	60	10		22583	W	A		FKM
45	60	10		17662	W	A		NBR
45	60	10		17664	W	B		NBR
45	60	10		17665	W	C		NBR
45	60	10		40328	W	B	S	NBR
45	60	10		63213	W	A	S	FKM
45	60	10		17663	W	A	S	NBR
45	60	12		40876	W	A	S	NBR
45	60	12		26407	W	A		NBR
45	60	12		104309	W	A		FKM





油封

尺寸



d1	d2	H	H2	产品编码	产品组	设计型号	形式	材质
45	60	12		17666	W	C		NBR
45	61	9		19241	W	A	S	NBR
45	61	9		40878	W	A		NBR
45	61	10		40329	W	B	S	NBR
45	61	10		17667	W	B		NBR
45	62	6		129769	W	A	SY	NBR
45	62	6		129768	W	A	SY	FKM
45	62	7		48641	W	A	SY	FKM
45	62	7		24351	W	A	SY	NBR
45	62	7		175682	W	A		NBR
45	62	7		17668	W	A		NBR
45	62	7		19242	W	B	S	NBR
45	62	7		38653	W	B		NBR
45	62	7		17669	W	A	S	NBR
45	62	7		21208	W	A	S	FKM
45	62	7		156684	W	A	O	NBR
45	62	7		20746	W	A		FKM
45	62	7		131076	W	A	S	FKM
45	62	8		19243	W	A	S	NBR
45	62	8		38687	W	B	S	NBR
45	62	8		40330	W	B		NBR
45	62	8		17670	W	A		NBR
45	62	8		20361	W	A		FKM
45	62	8		56698	W	A	S	FKM
45	62	8.5		39642	W	A	S	NBR
45	62	9		40331	W	B	S	NBR
45	62	9		19244	W	A		NBR
45	62	9		19245	W	A	S	NBR
45	62	9		42069	W	B		NBR
45	62	10		20362	W	A		FKM
45	62	10		17672	W	A	S	NBR
45	62	10		17674	W	C		NBR
45	62	10		17675	W	C	S	NBR
45	62	10		60647	W	A	S	FKM
45	62	10		18642	W	B	S	NBR
45	62	10		17671	W	A		NBR
45	62	10		17673	W	B		NBR
45	62	10		143425	W	A	S	FKM
45	62	11		39644	W	A	S	NBR
45	62	12		17679	W	C	S	NBR
45	62	12		17676	W	A		NBR
45	62	12		22584	W	A		FKM
45	62	12		40332	W	B	S	NBR
45	62	12		17678	W	C		NBR
45	62	12		17677	W	B		NBR
45	62	12		19246	W	A	S	NBR
45	63	7		40333	W	B	S	NBR
45	63	10		157346	W	A	S	FKM
45	63.5	6.5		42070	W	B		NBR
45	63.5	9.5		63237	W	A		FKM
45	63.5	10		39645	W	A	S	NBR
45	64	8		40879	W	A	S	NBR
45	64	9.5		40880	W	A		NBR
45	64	12		34353	W	C	S	NBR
45	65	5		39646	W	A	S	NBR

Any seal. Any time.

www.dichtomatik.de



油封

尺寸

d1	d2	H	H2	产品编码	产品组	设计型号	形式	材质
45	65	5		39057	W	B	O	NBR
45	65	6		39647	W	A		NBR
45	65	6		160588	W	A	S	FKM
45	65	7		92854	W	A	SY	FKM
45	65	7		35297	W	A		NBR
45	65	7		35654	W	A	SY	NBR
45	65	8		17680	W	A		NBR
45	65	8		69895	W	C		FKM
45	65	8		62527	W	A	S	FKM
45	65	8		157258	W	A	SY	FKM
45	65	8		130760	W	A		FKM
45	65	8		7367	W	A	SY	NBR
45	65	8		25652	W	A	S	NBR
45	65	8		176073	W	A	S	NBR
45	65	8		131057	W	A	S	FKM
45	65	8		20363	W	A		FKM
45	65	8		19247	W	B	S	NBR
45	65	8		18479	W	B		NBR
45	65	9		44460	W	A		NBR
45	65	10		17683	W	B		NBR
45	65	10		118624	W	B	S	NBR
45	65	10		20364	W	A		FKM
45	65	10		131064	W	A	S	FKM
45	65	10		17682	W	A	S	NBR
45	65	10		17684	W	C		NBR
45	65	10		17681	W	A		NBR
45	65	10		63245	W	A	S	FKM
45	65	12		63246	W	A		FKM
45	65	12		17685	W	A		NBR
45	65	12		17686	W	B	S	NBR
45	65	12		17027	W	B		NBR
45	65	12		39648	W	A	S	NBR
45	65	12		17687	W	C		NBR
45	65	12		93276	W	C	S	NBR
45	65	12		17688	W	C	S	NBR
45	66	6		178921	W	A	S	NBR
45	66	6		84144	W	A	S	NBR
45	66	6		20747	W	A		FKM
45	66	6		56350	W	A		NBR
45	66	9		39649	W	A		NBR
45	66	10		17689	W	A		NBR
45	66	10		63252	W	A		FKM
45	67	8		163119	W	A		NBR
45	68	5		40881	W	A	O	NBR
45	68	8		25919	W	A		NBR
45	68	8		39650	W	A	S	NBR
45	68	9		19248	W	A	S	NBR
45	68	10		17692	W	C		NBR
45	68	10		44796	W	A		FKM
45	68	10		39651	W	A	S	NBR
45	68	10		17690	W	A		NBR
45	68	10		17691	W	B		NBR
45	68	10.8		40883	W	A		NBR
45	68	12		17694	W	C		NBR
45	68	12		40334	W	B	S	NBR





油封

尺寸



d1	d2	H	H2	产品编码	产品组	设计型号	形式	材质
45	68	12		19250	W	A	S	NBR
45	68	12		129994	W	A	SY	NBR
45	68	12		159879	W	A	S	FKM
45	68	12		17693	W	B		NBR
45	68	12		19249	W	A		NBR
45	68	12.5		39652	W	A		NBR
45	68	14		40882	W	A	S	NBR
45	68.2	12		63266	W	A		FKM
45	68.2	12		19855	W	A		NBR
45	69	9		42071	W	B	O	NBR
45	69.1	12		72739	W	A		NBR
45	70	5		39653	W	A	S	NBR
45	70	8		179150	W	A	S	NBR
45	70	10		20250	W	A		NBR
45	70	10		39654	W	A	S	NBR
45	70	10		180996	W	A	S	FKM
45	70	10		17695	W	B		NBR
45	70	10		17696	W	C		NBR
45	70	10		104310	W	A		FKM
45	70	12		17699	W	C		NBR
45	70	12		19251	W	A	S	NBR
45	70	12		17697	W	A		NBR
45	70	12		20365	W	A		FKM
45	70	12		17698	W	B		NBR
45	70	14		26408	W	A		NBR
45	71	6.5		40884	W	A	S	NBR
45	72	7		47274	W	A		NBR
45	72	8		36448	W	A	S	FKM
45	72	8		18694	W	A		NBR
45	72	8		130783	W	A		FKM
45	72	8		17701	W	B	S	NBR
45	72	8		36447	W	A		FKM
45	72	8		17700	W	A	S	NBR
45	72	8		130989	W	A	S	FKM
45	72	8		38654	W	B		NBR
45	72	9		63287	W	A		FKM
45	72	9		173468	W	B	SY	FKM
45	72	9		17702	W	A		NBR
45	72	10		37224	W	A	S	NBR
45	72	10		17703	W	A		NBR
45	72	10		17704	W	B		NBR
45	72	10		17705	W	C		NBR
45	72	10		20366	W	A		FKM
45	72	10		60352	W	A	S	FKM
45	72	10		175767	W	A	S	NBR
45	72	12		17707	W	B		NBR
45	72	12		17708	W	B	S	NBR
45	72	12		63288	W	A		FKM
50	65	8		167589	W	A	S	FKM
45	72	12		19252	W	A	S	NBR
45	72	12		40496	W	B	O	NBR
45	72	12		17706	W	A		NBR
45	72	12		17709	W	C		NBR
45	72	13		39655	W	A	S	NBR
45	74	12		81252	W	A	S	NBR

Any seal. Any time.

www.dichtomatik.de



油封

尺寸

d1	d2	H	H2	产品编码	产品组	设计型号	形式	材质
45	74	12		40335	W	B	S	NBR
45	74.5	12		19863	W	A	S	NBR
45	75	6		39656	W	A	S	NBR
45	75	6		26563	W	A		NBR
45	75	7		39657	W	A	S	NBR
45	75	7		135227	W	A	S	FKM
45	75	8		17710	W	B	S	NBR
45	75	8		19253	W	A	S	NBR
45	75	8		62528	W	A	S	FKM
45	75	8		179067	W	A		FKM
45	75	8		38442	W	A		NBR
45	75	10		56804	W	A	S	FKM
45	75	10		17711	W	A		NBR
45	75	10		19254	W	A	S	NBR
45	75	10		130932	W	A	S	NBR
45	75	10		17713	W	C		NBR
45	75	10		17712	W	B		NBR
45	75	10		19697	W	B	S	NBR
45	75	10		56803	W	A		FKM
45	75	12		17714	W	C		NBR
45	75	12		19256	W	B	S	NBR
45	75	12		19255	W	A	S	NBR
45	75	12.5		40336	W	B	S	NBR
45	75	13		17715	W	C		NBR
45	75	15		40885	W	A	S	NBR
45	78	8		39658	W	A	S	NBR
45	78	10		179151	W	A	S	NBR
45	78	12		39659	W	A	S	NBR
45	78	13		117854	W	C		NBR
45	78	13		19257	W	A		NBR
45	80	10		19731	W	B		NBR
45	80	10		22585	W	A		FKM
45	80	10		17716	W	A		NBR
45	80	10		34805	W	A	S	NBR
45	80	10		73231	W	A	S	FKM
45	80	10		170788	W	A	S	NBR
45	80	10		17717	W	C		NBR
45	80	12		17718	W	C		NBR
45	80	12		39660	W	A	S	NBR
45	80	13		19753	W	B		NBR
45	80	13		17720	W	C		NBR
45	80	13		19258	W	A	S	NBR
45	80	13		63308	W	A		FKM
45	80	13		17719	W	A		NBR
45	80	13		83756	W	B	S	NBR
45	85	8		39661	W	A	S	NBR
45	85	8		38655	W	B		NBR
45	85	10		130809	W	A		FKM
45	85	10		17722	W	B		NBR
45	85	10		17723	W	C		NBR
45	85	10		34806	W	A	S	NBR
45	85	10		62646	W	A		FKM
45	85	10		17721	W	A		NBR
45	85	10		74479	W	A	S	FKM
45	85	13		27678	W	A		NBR





油封

尺寸



d1	d2	H	H2	产品编码	产品组	设计型号	形式	材质
45	85	13		17724	W	C		NBR
45	90	10		17725	W	A	S	NBR
45	90	10		19259	W	A		NBR
45	90	10		34354	W	C		NBR
45	90	10		63343	W	A	S	FKM
45	100	8		75070	W	A	S	NBR
45	100	9.5		166924	W	A		FKM
45	100	10		175453	W	A		NBR
45	100	10		132867	W	A	S	FKM
45	100	10		39662	W	A	S	NBR
45	100	10		47276	W	A		NBR
45	100	12		179147	W	A	S	NBR
45	120	12		82202	W	A	S	NBR
45.64	65.23	10.59		59706	W	A		NBR
45.65	60.32	6.35		104325	W	A		FKM
46	56	9		42072	W	B		NBR
46	58	5		40886	W	A	O	NBR
46	59	12		39663	W	A	S	NBR
46	60	7		68010	W	A	S	NBR
46	60	7		19754	W	B		NBR
46	60	8		65443	W	A	S	NBR
46	62	8		19260	W	A	S	NBR
46	62	9		26409	W	A		NBR
46	64	8		63238	W	A		FKM
46	64	8		17726	W	A		NBR
46	64	8		39664	W	A	S	NBR
46	64	9		57152	W	A		FKM
46	64	9		25650	W	A	S	NBR
46	64	14		83446	W	A	S	NBR
46	65	7		19261	W	A	S	NBR
46	65	8		60319	W	A	S	FKM
46	65	9		19262	W	A	S	NBR
46	65	10		40390	W	C		NBR
46	65	21		89774	W	B		NBR
46	70	10		40887	W	A	S	NBR
46	70	14		39665	W	A	S	NBR
46	72	10		83173	W	A		FKM
46	72	10		16460	W	A		NBR
46	73	10		40888	W	A	S	NBR
46	78	10		19820	W	B		NBR
46	78	10		26410	W	A		NBR
46	81.03	10		40337	W	B	S	NBR
46.03	61.91	7.93		60533	W	B		NBR
46.03	63.5	6.35		19953	W	A		NBR
46.03	63.5	9.52		59470	W	B		NBR
46.03	63.5	9.52		59867	W	A	S	NBR
46.03	63.5	9.52		20104	W	A		NBR
46.03	66.67	9.52		20839	W	A		NBR
46.03	66.67	9.52		60703	W	B	S	NBR
46.03	69.85	12.7		20105	W	A		NBR
46.03	69.85	12.7		60532	W	B		NBR
46.03	76.2	9.52		56408	W	A		NBR
46.2	80	10		39667	W	A		NBR
46.8	61.3	4		31011	W	A		NBR
46.84	69.85	9.52		60704	W	B	S	NBR

Any seal. Any time.

www.dichtomatik.de



油封

尺寸

d1	d2	H	H2	产品编码	产品组	设计型号	形式	材质
47	54	3.5		40889	W	A	O	NBR
47	55	10		42074	W	B	O	NBR
47	58	6		22586	W	A		FKM
47	58	6		56982	W	A		NBR
47	58	7		19263	W	A		NBR
47	58	7		39666	W	A	S	NBR
47	60	7		180015	W	A	S	NBR
47	62	6		161735	W	A		NBR
47	62	6		48646	W	A		FKM
47	62	6		39668	W	A		NBR
47	62	7		118699	W	A	SY	NBR
47	62	7		163392	W	A	S	NBR
47	62	8		19264	W	A		NBR
47	63	12		42073	W	B		NBR
47	64	8		40890	W	A	S	NBR
47	65	8		19265	W	A		NBR
47	65	9		40891	W	A		NBR
47	65	10		17727	W	A		NBR
47	65	10		157259	W	A	SY	FKM
47	65	10		157302	W	A	SY	NBR
47	65	10		20368	W	A		FKM
47	65	12		39062	W	C	S	NBR
47	65	12		41441	W	C		NBR
47	66	6		77686	W	B	S	NBR
47	67	10		83447	W	A	S	NBR
47	67	12		17728	W	A		NBR
47	67	12		63254	W	A		FKM
47	68	6		40892	W	A		NBR
47	68	13		19267	W	B	S	NBR
47	69.9	9		42075	W	B		NBR
47	70	8		40893	W	A	S	NBR
47	70	10		19266	W	A	S	NBR
47	70	11		39669	W	A	S	NBR
47	70	12		158873	W	C		NBR
47	70	12		39670	W	A	S	NBR
47	72	8		40338	W	B		NBR
47	72	9		17729	W	A		NBR
47	72	9		63289	W	A		FKM
47	72	10		44247	W	A		NBR
47	72	10		25967	W	C		NBR
47	72	12		18480	W	B		NBR
47	75	12		48736	W	C		NBR
47	76.5	9		39671	W	A	S	NBR
47	80	8		83174	W	A		FKM
47	80	10		104327	W	A		FKM
47	80	12		39672	W	A	S	NBR
47.02	66.67	9.52		39673	W	A		NBR
47.62	60.32	6.35		20106	W	A		NBR
47.62	60.32	6.35		3995	W	B		NBR
47.62	60.91	6.35		60534	W	B		NBR
47.62	63.5	6.35		20107	W	A		NBR
47.62	63.5	7.93		20108	W	A		NBR
47.62	63.5	9.52		20109	W	A		NBR
47.62	63.5	9.52		59868	W	A	S	NBR
47.62	63.5	12.7		60845	W	C		NBR





油封

尺寸



d1	d2	H	H2	产品编码	产品组	设计型号	形式	材质
47.62	63.5	12.7		19954	W	A		NBR
47.62	63.65	6.35		57163	W	B	O	NBR
47.62	65.08	6.35		19955	W	A		NBR
47.62	66.67	7.93		35366	W	C		NBR
47.62	66.67	7.93		35365	W	B		NBR
47.62	66.67	7.93		60706	W	B	S	NBR
47.62	66.67	9.52		60535	W	B		NBR
47.62	66.67	9.52		59869	W	A	S	NBR
47.62	66.67	9.52		20110	W	A		NBR
47.62	66.67	11.51		38368	W	B		NBR
47.62	66.67	12.7		20111	W	A		NBR
47.62	68.26	9.52		163158	W	B	S	NBR
47.62	69.85	7.93		60707	W	B	S	NBR
47.62	69.85	7.93		60536	W	B		NBR
47.62	69.85	9.52		60537	W	B		NBR
47.62	69.85	9.52		59870	W	A	S	NBR
47.62	69.85	9.52		20112	W	A		NBR
47.62	69.85	9.52		60705	W	B	S	NBR
47.62	69.85	11.91		81365	W	B		NBR
47.62	69.85	12.7		19958	W	A		NBR
47.62	69.85	12.7		60538	W	B		NBR
47.62	69.85	12.7		59871	W	A	S	NBR
47.62	69.85	12.7		56805	W	A		FKM
47.62	70.65	13.5		40339	W	B	S	NBR
47.62	70.66	11.11		60846	W	C		NBR
47.62	70.84	15.87		39636	W	A	S	FKM
47.62	73.02	7.93		75266	W	C		NBR
47.62	73.02	7.93		60539	W	B		NBR
47.62	73.02	9.52		20113	W	A		NBR
47.62	73.02	9.52		59872	W	A	S	NBR
47.62	73.02	12.7		20114	W	A		NBR
47.62	76.2	7.93		75267	W	C		NBR
47.62	76.2	9.52		37745	W	B		NBR
47.62	76.2	9.52		59873	W	A	S	NBR
47.62	76.2	9.52		20115	W	A		NBR
47.62	76.2	12.7		20116	W	A		NBR
47.62	77.75	7.93		60708	W	B	S	NBR
47.62	79.37	12.7		59874	W	A	S	NBR
47.62	80.96	11.11		75268	W	C		NBR
47.62	80.96	12.7		19966	W	A		NBR
47.62	90.96	11.11		75269	W	C		NBR
47.96	60	6		57287	W	B		NBR
47.98	62.99	8.99		60709	W	B	S	NBR
48	55	4		57132	W	A		NBR
48	58	4		44286	W	B		NBR
48	58	4		19588	W	A	O	NBR
48	58	4		44226	W	A		NBR
48	58	7		179872	W	A	S	NBR
48	58.5	4.7		155907	W	A		NBR
48	60	7		39674	W	A	S	NBR
48	60	9		39675	W	A	S	NBR
48	60	10		39676	W	A	S	NBR
48	62	5		19780	W	A	O	NBR
48	62	6		42076	W	B	O	NBR
48	62	6		39677	W	A	S	NBR

Any seal. Any time.

www.dichtomatik.de



油封

尺寸

d1	d2	H	H2	产品编码	产品组	设计型号	形式	材质
48	62	7		19269	W	B	S	NBR
48	62	7		81253	W	A		NBR
48	62	7		19268	W	A	S	NBR
48	62	7		19853	W	B		NBR
48	62	8		18664	W	A	S	NBR
48	62	8		25964	W	B		NBR
48	62	8		17730	W	A		NBR
48	62	8		82728	W	B	S	NBR
48	62	8		20369	W	A		FKM
48	62	8		48649	W	A	S	FKM
48	62	9		39063	W	C	S	NBR
48	62	9		40340	W	B	S	NBR
48	62	9		39678	W	A	S	NBR
48	62	9		40341	W	B		NBR
48	62	10		17732	W	B		NBR
48	62	10		19270	W	A	S	NBR
48	62	10		17731	W	A		NBR
48	62	10		63235	W	A		FKM
48	62	11		39064	W	A	S	NBR
48	62	12		42077	W	B	S	NBR
48	62	12		19271	W	A	S	NBR
48	62	12		69323	W	A		NBR
48	62	13		19732	W	C		NBR
48	63	11		81254	W	A		NBR
48	64	14		163159	W	B	S	NBR
48	65	7		39679	W	A	S	NBR
48	65	7		83175	W	A		FKM
48	65	8		27034	W	A		NBR
48	65	8		62529	W	A	S	FKM
48	65	8		40870	W	A	S	NBR
48	65	9		19272	W	A	S	NBR
48	65	10		20467	W	A		FKM
48	65	10		40342	W	B	S	NBR
48	65	10		17734	W	B		NBR
48	65	10		22514	W	A	S	FKM
48	65	10		19273	W	A	S	NBR
48	65	10		17733	W	A		NBR
48	65	10		17735	W	C		NBR
48	65	12		19274	W	A		NBR
48	65	12		19275	W	B	S	NBR
48	65	12		17736	W	C		NBR
48	65	12		39680	W	A	S	NBR
48	65	14		17737	W	B		NBR
48	65	15		40894	W	A	S	NBR
48	66	10		17738	W	B		NBR
48	66	12		19276	W	A	S	NBR
48	66	13		19277	W	B	S	NBR
48	66.8	9.8		40895	W	A		NBR
48	67	10		83448	W	A	S	NBR
48	68	8		81237	W	A	S	NBR
48	68	8		104322	W	A		FKM
48	68	8		62530	W	A	S	FKM
48	68	10		19279	W	A	S	NBR
48	68	10		38727	W	C		NBR
48	68	10		17739	W	B		NBR





油封

尺寸



d1	d2	H	H2	产品编码	产品组	设计型号	形式	材质
48	68	10		19278	W	A		NBR
48	68	11		39681	W	A	S	NBR
48	68	12		17740	W	A		NBR
48	68	12		38726	W	C		NBR
48	68	12		63261	W	A		FKM
48	68	12		39682	W	A	S	NBR
48	68	14		63262	W	A	S	FKM
48	68	14		17741	W	A	S	NBR
48	69	10		39683	W	A	S	NBR
48	70	8		19280	W	A		NBR
48	70	9		83397	W	A		NBR
48	70	9		39684	W	A	S	NBR
48	70	9.5		40343	W	B	S	NBR
48	70	10		17742	W	A		NBR
48	70	10		63270	W	A		FKM
48	70	10		39685	W	A	S	NBR
48	70	10		19874	W	C		NBR
48	70	11		19281	W	A	S	NBR
48	70	12		19282	W	A		NBR
48	70	12		19284	W	B		NBR
48	70	12		17743	W	C		NBR
48	70	12		129995	W	A	SY	NBR
48	70	12		19283	W	A	S	NBR
48	72	7		17744	W	A		NBR
48	72	7		17745	W	A	S	NBR
48	72	8		38666	W	B		NBR
48	72	8		62532	W	A		FKM
48	72	8		19285	W	A		NBR
48	72	8		18662	W	A	S	NBR
48	72	8		22515	W	A	S	FKM
48	72	9		19286	W	A		NBR
48	72	10		19287	W	A	S	NBR
48	72	10		20371	W	A		FKM
48	72	10		17747	W	B		NBR
48	72	10		19733	W	C		NBR
48	72	10		17746	W	A		NBR
48	72	10		126723	W	A	SY	NBR
48	72	12		17748	W	A		NBR
48	72	12		40497	W	A	O	NBR
48	72	12		17750	W	C		NBR
48	72	12		17749	W	B		NBR
48	72	12		19288	W	A	S	NBR
48	72	12		63290	W	A		FKM
48	72.5	10		166366	W	A	Y	NBR
48	72.5	10		19289	W	A	S	NBR
48	72.5	10		19734	W	A		NBR
48	74	10		39686	W	A	S	NBR
48	74	10		19860	W	A		NBR
48	74	10		63295	W	A		FKM
48	74	11		40344	W	B	S	NBR
48	75	8		44107	W	A		NBR
48	75	12		39687	W	A	S	NBR
48	78	10		85237	W	C		NBR
48	79	9		39689	W	A	S	NBR
48	80	8		39691	W	A	S	NBR

Any seal. Any time.

www.dichtomatik.de



油封

尺寸

d1	d2	H	H2	产品编码	产品组	设计型号	形式	材质
48	80	8		19290	W	A		NBR
48	80	8		104311	W	A		FKM
48	80	10		17751	W	A		NBR
48	80	10		20372	W	A		FKM
48	80	10		39690	W	A	S	NBR
48	80	10		17752	W	C		NBR
48	80	12		39692	W	A	S	NBR
48	80	13		17754	W	C		NBR
48	80	13		17753	W	A		NBR
48	82	12		40345	W	B	S	NBR
48	82	12		81255	W	A	S	NBR
48	82	13		40346	W	B	S	NBR
48	85	6		17755	W	A		NBR
48	85	6		63320	W	A		FKM
48	85	10		63321	W	A		FKM
48	85	10		17756	W	A		NBR
48	85	13		63322	W	A		FKM
48	85	13		17757	W	A		NBR
48	90	10		17758	W	A		NBR
48	90	10		169949	W	A	S	NBR
48	90	10		63341	W	A		FKM
48	90	12		17759	W	A		NBR
48	90	13		17760	W	C		NBR
48	90	13		26200	W	A	S	NBR
49	56	9		42078	W	B	O	NBR
49	62	10		179308	W	A	S	NBR
49	65	10		21578	W	A		NBR
49	68	7		40932	W	A		NBR
49	68	9		19291	W	A	S	NBR
49	68	12		36203	W	A		NBR
49	68	13.8		89772	W	B		NBR
49	70	9.5		19735	W	A		NBR
49	72	10		40933	W	A	S	NBR
49	77.5	11.23		28010	W	B		NBR
49.02	76.2	12.7		60540	W	B		NBR
49.2	69.95	9.5		63268	W	A		FKM
49.2	79.38	9.65		48737	W	C		NBR
49.21	61.91	6.35		60543	W	B		NBR
49.21	63.5	9.52		60541	W	B		NBR
49.21	63.5	9.52		20117	W	A		NBR
49.21	63.5	9.52		59875	W	A	S	NBR
49.21	63.75	7.14		60766	W	B	O	NBR
49.21	69.85	9.52		27023	W	A	S	NBR
49.21	69.85	9.52		20118	W	A		NBR
49.21	76.2	7.93		60542	W	B		NBR
49.21	76.2	7.93		60710	W	B	S	NBR
49.21	76.2	12.7		59707	W	A		NBR
49.21	76.2	12.7		59876	W	A	S	NBR
49.21	76.2	12.7		60847	W	C		NBR
49.21	76.2	14.7		74246	W	C		NBR
49.21	90.11	12.7		38725	W	C		NBR
49.21	95.25	12.7		60893	W	C		NBR
49.5	60	8		83421	W	A		NBR
49.5	70	10		39693	W	A	S	NBR
49.5	77	18		39694	W	A	S	NBR





油封

尺寸



d1	d2	H	H2	产品编码	产品组	设计型号	形式	材质
50	58	4		74073	W	B	O	NBR
50	58	4		48958	W	A	O	FKM
50	58	4		22094	W	A	OK	NBR
50	58	4		144591	W	A	O	NBR
50	58	4.5		40934	W	A		NBR
50	58	5		42080	W	B	O	NBR
50	58	5		159811	W	A		FKM
50	58	8		59611	W	A		FKM
50	59	4		159434	W	A	O	FKM
50	59	4		19292	W	A		NBR
50	60	4		40935	W	A	OK	NBR
50	60	7		56806	W	A		FKM
50	60	7		40936	W	A		NBR
50	60	7.5		40937	W	A	S	NBR
50	60	8		127324	W	A	S	NBR
50	60	8		38751	W	A		NBR
50	60	10		60361	W	A		NBR
50	62	5		22095	W	A	OK	NBR
50	62	5		158496	W	A	O	FKM
50	62	7		39197	W	A	S	NBR
50	62	7		49298	W	A	S	FKM
50	62	7		20373	W	A		FKM
50	62	7		17761	W	A		NBR
50	62	7		17762	W	B		NBR
50	62	7		172683	W	A		NBR
50	62	8		39695	W	A	S	NBR
50	62	8		118798	W	A		FKM
50	62	8		39696	W	A		NBR
50	62	8		130850	W	A		FKM
50	62	10		38688	W	B	S	NBR
50	62	10		38724	W	C		NBR
50	62	10		19293	W	A		NBR
50	62	10		17763	W	B		NBR
50	64	8		39697	W	A	S	NBR
50	64	10		19294	W	A		NBR
50	64	10		19295	W	A	S	NBR
50	65	6		19296	W	A	S	NBR
50	65	6		19782	W	B	O	NBR
50	65	7		121415	W	A	Y	NBR
50	65	7		44457	W	A	SY	NBR
50	65	7		64230	W	A		NBR
50	65	8		90610	W	A	SY	NBR
50	65	8		17764	W	A		NBR
50	65	8		17766	W	B		NBR
50	65	8		20374	W	A		FKM
50	65	8		130780	W	A		FKM
50	65	8		22516	W	A	S	FKM
50	65	8		17765	W	A	S	NBR
50	65	8		169836	W	A		FKM
50	65	8		131051	W	A	S	FKM
50	65	8		72659	W	B	S	NBR
50	65	8		157260	W	A	SY	FKM
55	100	10		152972	W	A	S	FKM
50	65	9		19297	W	A	S	NBR
50	65	9		132907	W	A		FKM

Any seal. Any time.

www.dichtomatik.de



油封

尺寸

d1	d2	H	H2	产品编码	产品组	设计型号	形式	材质
50	65	9		40347	W	B	S	NBR
50	65	10		69905	W	C		FKM
50	65	10		17769	W	C		NBR
50	65	10		17767	W	A		NBR
50	65	10		17768	W	B		NBR
50	65	10		39698	W	A	S	NBR
50	65	10		40348	W	B	S	NBR
50	65	10		63248	W	A		FKM
50	65	10		158238	W	A	S	NBR
50	65	12		17770	W	B		NBR
50	65	12		27679	W	A		NBR
50	65	12		17771	W	C		NBR
50	66	7.93		44094	W	A		NBR
50	66	8		38752	W	A		NBR
50	66	10		17772	W	A		NBR
50	66	10		63253	W	A		FKM
50	67	7		40938	W	A	S	NBR
50	67	9		39699	W	A	S	NBR
50	67	9		19298	W	A		NBR
50	67	11		39700	W	A	S	NBR
50	68	7		157217	W	A	SY	FKM
50	68	7		118700	W	A	SY	NBR
50	68	7		19783	W	A	O	NBR
50	68	8		19755	W	B		NBR
50	68	8		47284	W	A	SY	NBR
50	68	8		56808	W	A	S	FKM
50	68	8		17773	W	A		NBR
50	68	8		20748	W	A		FKM
50	68	8		37207	W	A	S	NBR
50	68	8		157261	W	A	SY	FKM
50	68	9		40391	W	C	S	NBR
50	68	9		69486	W	C		NBR
50	68	9		19299	W	A	S	NBR
50	68	9		40349	W	B	S	NBR
50	68	9		83393	W	A		NBR
50	68	10		83193	W	A	S	FKM
50	68	10		64967	W	A		NBR
50	68	10		37908	W	A	S	NBR
50	68	10		19736	W	B	S	NBR
50	68	10		20375	W	A		FKM
50	68	10		17774	W	A		NBR
50	68	10		17775	W	C		NBR
50	68	10		25968	W	B		NBR
50	68	11		19300	W	A		NBR
50	68	12		17777	W	C		NBR
50	68	12		17776	W	A		NBR
50	68	12		63263	W	A		FKM
50	68	12		42081	W	B	S	NBR
50	68	14		175712	W	B		NBR
50	68	14		17778	W	B		NBR
50	68	14		40350	W	B	S	NBR
50	68	14		19301	W	A		NBR
50	70	6		19302	W	A	S	NBR
50	70	7		40392	W	C	S	NBR
50	70	8		62533	W	A		FKM





油封

尺寸



d1	d2	H	H2	产品编码	产品组	设计型号	形式	材质
50	70	8		44566	W	C		NBR
50	70	8		19303	W	B	S	NBR
50	70	8		179155	W	A	S	FKM
50	70	8		24363	W	A		NBR
50	70	8		39701	W	A	S	NBR
50	70	8		40351	W	B		NBR
50	70	8		68263	W	C	S	NBR
50	70	9		39703	W	A	S	NBR
50	70	9		40352	W	B		NBR
50	70	9		39702	W	A		NBR
50	70	9		39049	W	B	S	NBR
50	70	9.5		39704	W	A	S	NBR
50	70	10		17779	W	A		NBR
50	70	10		20376	W	A		FKM
50	70	10		85486	W	B	S	NBR
50	70	10		19304	W	A	S	NBR
50	70	10		56679	W	B	S	NBR
50	70	10		17780	W	B		NBR
50	70	10		75381	W	A	SY	NBR
50	70	10		38949	W	A	S	FKM
50	70	10		17781	W	C		NBR
50	70	10		130837	W	A		FKM
50	70	11		39705	W	A	S	NBR
50	70	12		17782	W	A		NBR
50	70	12		17783	W	B		NBR
50	70	12		20377	W	A		FKM
50	70	12		19305	W	A	S	NBR
50	70	12		17784	W	C		NBR
50	70	13.5		39706	W	A	S	NBR
50	70	13.5		156693	W	B	S	NBR
50	70	14		19306	W	B		NBR
50	70	14		40939	W	A	S	NBR
50	72	5		19784	W	A	O	NBR
50	72	6		40940	W	A		NBR
50	72	7		39707	W	A	S	NBR
50	72	7		79626	W	A	SY	NBR
50	72	7		79894	W	A	SY	FKM
50	72	7		22517	W	A	S	FKM
50	72	8		38667	W	B		NBR
50	72	8		75962	W	A	SY	FKM
50	72	8		170605	W	A		FKM
50	72	8		27538	W	A	S	NBR
50	72	8		17785	W	A		NBR
50	72	8		36449	W	A	S	FKM
50	72	8		40353	W	B	S	NBR
50	72	8		20378	W	A		FKM
50	72	9		19307	W	A	S	NBR
50	72	10		19308	W	A	S	NBR
50	72	10		22518	W	A	S	FKM
50	72	10		20379	W	A		FKM
50	72	10		17786	W	A		NBR
50	72	10		17787	W	B		NBR
50	72	10		17788	W	C		NBR
50	72	12		17790	W	B		NBR
50	72	12		19309	W	A	S	NBR

Any seal. Any time.

www.dichtomatik.de



油封

尺寸

d1	d2	H	H2	产品编码	产品组	设计型号	形式	材质
50	72	12		22587	W	A		FKM
50	72	12		17791	W	C		NBR
50	72	12		40195	W	B	S	NBR
50	72	12		48650	W	A	S	FKM
50	72	12		129996	W	A	SY	NBR
50	72	12		81390	W	C		FKM
50	72	12		17789	W	A		NBR
50	72	14		40941	W	A		NBR
50	73	8		40942	W	A	S	NBR
50	73	9		40393	W	C	S	NBR
50	73	10		40943	W	A	S	NBR
50	73.03	15.7		42082	W	C	S	NBR
50	74	8		42083	W	C		NBR
50	74	9		40944	W	A		NBR
50	75	6		40945	W	A	O	NBR
50	75	6		40946	W	A	S	NBR
50	75	9		40196	W	B		NBR
50	75	10		38759	W	A	S	NBR
50	75	10		69906	W	A		FKM
50	75	10		130781	W	A		FKM
50	75	10		17792	W	C		NBR
50	75	10		39708	W	A		NBR
50	75	10		64113	W	B		NBR
50	75	10		48653	W	A	S	FKM
50	75	12		17794	W	C		NBR
50	75	12		17793	W	A		NBR
50	75	12		63298	W	A		FKM
50	75	12		19310	W	A	S	NBR
50	75	13		60359	W	A		NBR
50	76	10		39709	W	A		NBR
50	76	12		39710	W	A	S	NBR
50	76	13		40197	W	B	S	NBR
50	78	10		39713	W	A		NBR
50	78	12		40947	W	A	S	NBR
50	78	12		19311	W	A		NBR
50	80	8		131055	W	A	S	FKM
50	80	8		134472	W	A	SY	FKM
50	80	8		35791	W	B		NBR
50	80	8		20380	W	A		FKM
50	80	8		22519	W	A	S	FKM
50	80	8		17795	W	A		NBR
50	80	8		19312	W	A	S	NBR
50	80	8		159466	W	A		NBR
50	80	10		63309	W	A	S	FKM
50	80	10		17796	W	A		NBR
50	80	10		56900	W	C	S	NBR
50	80	10		35703	W	C		FKM
50	80	10		158826	W	A	SY	NBR
50	80	10		20381	W	A		FKM
50	80	10		17797	W	B		NBR
50	80	10		17798	W	C		NBR
50	80	10		19313	W	A	S	NBR
50	80	10		118514	W	A	S	FKM
50	80	10		130798	W	A		FKM
50	80	12		19315	W	A	S	NBR





油封

尺寸



d1	d2	H	H2	产品编码	产品组	设计型号	形式	材质
50	80	12		17799	W	B		NBR
50	80	12		19314	W	A		NBR
50	80	12		17800	W	C		NBR
50	80	13		17801	W	A		NBR
50	80	13		17803	W	C		NBR
50	80	13		17804	W	C	S	NBR
50	80	13		40198	W	B		NBR
50	80	13		22520	W	A	S	FKM
50	80	13		26201	W	A	S	NBR
50	80	14		19317	W	A		NBR
50	82	12		19318	W	A	S	NBR
50	85	8		19319	W	A		NBR
50	85	8		39712	W	A	S	NBR
50	85	10		39714	W	A	S	NBR
50	85	10		104312	W	A		FKM
50	85	10		17805	W	C		NBR
50	85	10		27536	W	A		NBR
50	85	10		61729	W	B		NBR
50	85	12		17807	W	B		NBR
50	85	12		17806	W	A		NBR
50	85	12		39715	W	A	S	NBR
50	85	13		17808	W	A		NBR
50	85	13		17809	W	C		NBR
50	85	13		63323	W	A		FKM
50	88	10		163116	W	A	S	NBR
50	90	6		83591	W	B	O	NBR
50	90	8		39716	W	A	S	NBR
50	90	10		17810	W	A		NBR
50	90	10		17811	W	A	S	NBR
50	90	10		17812	W	B		NBR
50	90	10		20383	W	A		FKM
50	90	10		121798	W	A	S	FKM
50	90	10		130768	W	A		FKM
50	90	10		17813	W	C		NBR
50	90	12		17814	W	C		NBR
50	90	12		39717	W	A	S	NBR
50	90	13		17816	W	C		NBR
50	90	13		38668	W	B		NBR
50	90	13		17815	W	A		NBR
50	95	7		36797	W	A		NBR
50	95	10		83469	W	C		NBR
50	110	10		121799	W	A	S	FKM
50	110	10		39722	W	A	S	NBR
50	110	10.5		69397	W	A		NBR
50	110	12		47348	W	A		NBR
50	125	10		150146	W	A	S	NBR
50.01	73.02	11.91		60848	W	C		NBR
50.4	76.2	12.7		75270	W	C	S	NBR
50.8	60.32	4.76		79539	W	B	O	NBR
50.8	60.32	4.76		59708	W	A		NBR
50.8	60.32	6.35		60767	W	B	O	NBR
50.8	63.5	6.35		59877	W	A	S	NBR
50.8	63.5	6.35		20119	W	A		NBR
50.8	63.5	6.35		56807	W	A		FKM
50.8	65	6		42084	W	B	O	NBR

Any seal. Any time.



油封

尺寸

d1	d2	H	H2	产品编码	产品组	设计型号	形式	材质
50.8	66.67	7.93		60711	W	B	S	NBR
50.8	66.67	9.52		20120	W	A		NBR
50.8	66.67	9.52		59878	W	A	S	NBR
50.8	68.26	9.52		19956	W	A		NBR
50.8	68.26	12.7		60544	W	B		NBR
50.8	68.26	12.7		20121	W	A		NBR
50.8	68.99	11.91		60849	W	C		NBR
50.8	69.85	6.35		60545	W	B		NBR
50.8	69.85	6.35		20122	W	A		NBR
50.8	69.85	7.93		60850	W	C		NBR
50.8	69.85	7.93		60712	W	B	S	NBR
50.8	69.85	9.52		59879	W	A	S	NBR
50.8	69.85	9.52		60894	W	C		NBR
50.8	69.85	9.52		19959	W	A		NBR
50.8	69.85	9.52		38149	W	A		FKM
50.8	69.85	9.52		60713	W	B	S	NBR
50.8	69.85	11.11		59880	W	A	S	NBR
50.8	69.85	11.11		59709	W	A		NBR
50.8	69.85	11.11		156704	W	A	S	FKM
50.8	69.85	12.7		19960	W	A		NBR
50.8	69.85	12.7		60546	W	B		NBR
50.8	69.85	12.7		83468	W	C		NBR
50.8	69.85	12.7		59881	W	A	S	NBR
50.8	73.02	7.93		60547	W	B		NBR
50.8	73.02	9.52		20123	W	A		NBR
50.8	73.02	9.52		59882	W	A	S	NBR
50.8	73.02	12.7		39753	W	A		NBR
50.8	73.02	12.7		60548	W	B		NBR
50.8	73.02	12.7		60851	W	C		NBR
50.8	73.81	7.93		81229	W	A		NBR
50.8	74.18	7.93		28009	W	A		NBR
50.8	76.2	6.35		60549	W	B		NBR
50.8	76.2	7.93		60550	W	B		NBR
50.8	76.2	7.93		60714	W	B	S	NBR
50.8	76.2	9.52		60715	W	B	S	NBR
50.8	76.2	9.52		20124	W	A		NBR
50.8	76.2	9.52		59883	W	A	S	NBR
50.8	76.2	9.52		42086	W	B		NBR
50.8	76.2	12.7		59884	W	A	S	NBR
50.8	76.2	12.7		48738	W	C		NBR
50.8	76.2	12.7		42085	W	B	S	NBR
50.8	76.2	12.7		60551	W	B		NBR
50.8	76.2	12.7		20125	W	A		NBR
50.8	77.78	12.7		59885	W	A	S	NBR
50.8	77.78	12.7		60895	W	C	S	NBR
50.8	79.37	9.52		20844	W	A		NBR
50.8	80.97	9.52		120758	W	C		NBR
50.8	82.55	9.52		20126	W	A		NBR
50.8	85.72	12.7		20127	W	A		NBR
50.8	88.9	12.7		20128	W	A		NBR
51	58	4		42087	W	B	O	NBR
51	64	7		40948	W	A	S	NBR
51	65	7		40199	W	B	S	NBR
51	65	9		40200	W	B	S	NBR
51	65	13		19320	W	A	S	NBR





油封

尺寸



d1	d2	H	H2	产品编码	产品组	设计型号	形式	材质
51	70	10		40949	W	A	S	NBR
51	72	10		18789	W	A		NBR
52	60	8		39059	W	A		NBR
52	62	8		20484	W	A		FKM
52	63	8		39723	W	A	S	NBR
52	65	6		40950	W	A	O	NBR
52	65	8		19321	W	A		NBR
52	65	9		19322	W	A	S	NBR
52	65	9		39724	W	A		NBR
52	65	9		19323	W	B	S	NBR
52	65	10		39725	W	A	S	NBR
52	68	7		17818	W	B		NBR
52	68	7		17817	W	A		NBR
52	68	7		46285	W	B	S	NBR
52	68	8		17819	W	B		NBR
52	68	8		19324	W	A		NBR
52	68	8		19325	W	A	S	NBR
52	68	8		20468	W	A		FKM
52	68	8		62531	W	A	S	FKM
52	68	8		18643	W	B	S	NBR
52	68	8		60357	W	C		NBR
52	68	9		40951	W	A		NBR
52	68	10		39726	W	A		NBR
52	68	10		74174	W	A	S	NBR
52	68	10		40201	W	B	S	NBR
52	68	10		157277	W	A	SY	NBR
52	68	10		17820	W	C		NBR
52	68	12		17821	W	C		NBR
52	68	13		44287	W	B		NBR
52	68	13		39727	W	A	S	NBR
52	68	13		44227	W	A		NBR
52	68	13.5		72972	W	B	S	NBR
52	69	10		63267	W	A		FKM
52	69	10		17822	W	A		NBR
52	69	10		39728	W	A	S	NBR
52	69	11		42088	W	B	O	NBR
52	69	12		17823	W	C		NBR
52	70	7		40953	W	A	S	NBR
52	70	8		39730	W	A	S	NBR
52	70	9		81238	W	B		NBR
52	70	9		19326	W	A	S	NBR
52	70	9		40202	W	B	S	NBR
52	70	10		39731	W	A		NBR
52	70	10		17824	W	C		NBR
52	70	10		107203	W	A	S	NBR
52	72	7		172698	W	A	SY	NBR
52	72	8		39732	W	A	S	NBR
52	72	8		18483	W	B		NBR
52	72	8		20384	W	A		FKM
52	72	8		22521	W	A	S	FKM
52	72	8		17825	W	A		NBR
52	72	9		19327	W	A	S	NBR
52	72	10		19328	W	A	S	NBR
52	72	10		20385	W	A		FKM
52	72	10		17826	W	A		NBR

Any seal. Any time.

www.dichtomatik.de



油封

尺寸

d1	d2	H	H2	产品编码	产品组	设计型号	形式	材质
52	72	10		18481	W	B		NBR
52	72	10		17827	W	C		NBR
52	72	12		19329	W	A	S	NBR
52	72	12		17829	W	C		NBR
52	72	12		17828	W	A		NBR
52	72	12		78372	W	B	S	NBR
52	72	12		18482	W	B		NBR
52	72	12		130047	W	A	SY	NBR
52	72	12		104313	W	A		FKM
52	75	9		39733	W	A	S	NBR
52	75	10		61730	W	B		NBR
52	75	10		39735	W	A		NBR
52	75	10		73232	W	A		FKM
52	75	10		17830	W	C		NBR
52	75	10		39734	W	A	S	NBR
52	75	12		19330	W	A	S	NBR
52	75	12		129997	W	A	SY	NBR
52	75	12		17831	W	A		NBR
52	75	12		176560	W	B	S	NBR
52	75	12		17832	W	C		NBR
52	75	12		22588	W	A		FKM
52	75	15		26165	W	A	S	NBR
52	76	13		31244	W	A		NBR
52	76.2	10		19865	W	A		NBR
52	78	12		40954	W	A	S	NBR
52	78	13		44248	W	A		NBR
52	80	8		19331	W	A		NBR
52	80	8		19332	W	A	S	NBR
52	80	10		17835	W	C		NBR
52	80	10		17833	W	A		NBR
52	80	10		17834	W	B		NBR
52	80	10		60355	W	A		FKM
52	80	12		17836	W	C		NBR
52	80	13		17838	W	C		NBR
52	80	13		63310	W	A		FKM
52	80	13		17837	W	A		NBR
52	80	13		26163	W	B	S	NBR
52	85	8		19333	W	A		NBR
52	85	10		17840	W	C		NBR
52	85	10		44288	W	B		NBR
52	85	10		39739	W	A	S	NBR
52	85	10		17839	W	A		NBR
52	85	12		17841	W	C		NBR
52	85	13		17842	W	C		NBR
52	90	13		17843	W	C		NBR
52.38	66.67	7.93		20129	W	A		NBR
52.38	66.67	7.93		39738	W	A	S	NBR
52.38	73.02	9.52		19961	W	A		NBR
52.38	73.02	9.52		59886	W	A	S	NBR
52.38	76.2	9.52		19963	W	A		NBR
52.38	76.2	12.7		60852	W	C		NBR
52.38	80.96	9.52		22234	W	A		NBR
52.38	80.96	9.52		60552	W	B		NBR
52.38	80.96	11.43		31610	W	A		NBR
53	65	10		39737	W	A	S	NBR





油封

尺寸



d1	d2	H	H2	产品编码	产品组	设计型号	形式	材质
53	65	10		40955	W	A		NBR
53	66	6.4		40952	W	A	S	NBR
53	68	10		17845	W	B		NBR
53	68	10		17844	W	A		NBR
53	68	10		40394	W	C		NBR
53	68	10		63264	W	A		FKM
53	68	13		60354	W	A		NBR
53	70	6		40956	W	A	O	NBR
53	72	10		19334	W	A	S	NBR
53	76.2	12.8		42089	W	C		NBR
53	79	10		47548	W	A		NBR
53	80	10		19821	W	A		NBR
53	80	10		63311	W	A		FKM
53	80	13		40395	W	C		NBR
53	97	8		163160	W	A		NBR
53.28	80.26	9.52		59710	W	A		NBR
53.5	90	6		179434	W	A	O	NBR
53.97	66.67	4.76		20130	W	A		NBR
53.97	68.26	7.93		20131	W	A		NBR
53.97	69.85	7.93		20132	W	A		NBR
53.97	69.85	9.52		20133	W	A		NBR
53.97	73.02	6.35		46825	W	B	O	NBR
53.97	73.02	9.52		38090	W	C		FKM
53.97	73.02	9.52		60553	W	B		NBR
53.97	73.02	9.52		59887	W	A	S	NBR
53.97	73.02	9.52		20134	W	A		NBR
53.97	73.02	11.11		60716	W	B	S	NBR
53.97	73.02	12.7		60554	W	B		NBR
53.97	73.02	12.7		20135	W	A		NBR
53.97	76.2	9.52		20136	W	A		NBR
53.97	76.2	9.52		60555	W	B		NBR
53.97	76.2	9.52		59888	W	A	S	NBR
53.97	76.2	11.11		60853	W	C		NBR
53.97	76.2	12.5		40396	W	C		NBR
53.97	76.2	12.7		60556	W	B		NBR
53.97	76.2	12.7		19964	W	A		NBR
53.97	76.2	12.7		59889	W	A	S	NBR
53.97	77.75	12.7		59890	W	A	S	NBR
53.97	79.37	9.52		20137	W	A		NBR
53.97	79.37	9.52		59891	W	A	S	NBR
53.97	79.37	11.11		40957	W	A		NBR
53.97	79.37	12.7		56810	W	A		FKM
53.97	79.37	12.7		37655	W	A		NBR
53.97	82.55	9.52		60557	W	B		NBR
53.97	82.55	9.52		59892	W	A	S	NBR
53.97	85.13	10		40203	W	B	S	NBR
53.97	85.62	9.52		60558	W	B		NBR
53.97	85.62	11.11		60854	W	C		NBR
53.97	85.62	11.91		59893	W	A	S	NBR
53.97	85.62	11.91		60717	W	B	S	NBR
53.97	85.72	7.93		60768	W	B	O	NBR
53.97	85.72	12.7		20138	W	A		NBR
53.97	88.9	9.52		60559	W	B		NBR
53.97	88.9	12.7		60560	W	B		NBR
53.97	88.9	12.7		20139	W	A		NBR

Any seal. Any time.

www.dichtomatik.de



d1	d2	H	H2	产品编码	产品组	设计型号	形式	材质
53.97	93	6.35		115606	W	B	O	NBR
53.98	81	11.9		40204	W	B	S	NBR
54	65	13		19335	W	B	S	NBR
54	65	13		39736	W	A	S	NBR
54	66	7		19336	W	A	S	NBR
54	68	10		39740	W	A	S	NBR
54	68	10.5		19854	W	A		NBR
54	68	10.5		63265	W	A		FKM
54	68	12		40958	W	A	S	NBR
54	70	9		40959	W	A	S	NBR
54	70	10		40960	W	A	S	NBR
54	70	10		38669	W	B		NBR
54	70	10		18695	W	A		NBR
54	70	12		22589	W	A		FKM
54	70	12		38723	W	C		NBR
54	72	5		19337	W	A		NBR
54	72	5		164262	W	A		NBR
54	72	8		39741	W	A		NBR
54	72	8		40961	W	A	S	NBR
54	72	9		39742	W	A	S	NBR
54	72	10		19338	W	A	S	NBR
54	72	10		17848	W	C		NBR
54	72	10		168767	W	A		NBR
54	72	10		17846	W	A		NBR
54	72	10		17847	W	B		NBR
54	72	10		63291	W	A		FKM
54	72	12		17849	W	B		NBR
54	72	12		17850	W	C		NBR
54	72.5	9		19339	W	B	S	NBR
54	72.5	9		39743	W	A		NBR
54	74	8		17851	W	A		NBR
54	74	8		27008	W	B		NBR
54	74	8		19340	W	B	S	NBR
54	74	8		63296	W	A		FKM
54	74	10		19341	W	A	S	NBR
54	75	12		40962	W	A		NBR
54	76	8		19342	W	A	S	NBR
54	76	12		19343	W	A		NBR
54	76	12.5		17852	W	A		NBR
54	76	12.5		63301	W	A		FKM
54	76	13		19344	W	A	S	NBR
54	76.2	10		39744	W	A	S	NBR
54	76.2	12.7		179921	W	A		FKM
54	76.5	13		40963	W	A	O	NBR
54	78	12		25920	W	A		NBR
54	79.2	12.8		42091	W	C	S	NBR
54	80	8		39745	W	A		NBR
54	80	10		17853	W	B		NBR
54	80	10		17854	W	C		NBR
54	80	12		17856	W	C		NBR
54	80	12		17855	W	B		NBR
54	80	13		17857	W	B		NBR
54	80	13		17858	W	C		NBR
54	80	13		19345	W	A	S	NBR
54	80.5	12		40964	W	A	S	NBR



油封

尺寸



油封

尺寸



d1	d2	H	H2	产品编码	产品组	设计型号	形式	材质
54	81	10		19346	W	A	S	NBR
54	81	10		63319	W	A	S	FKM
54	82	10		39746	W	A	S	NBR
54	82	11		17859	W	A		NBR
54	82	11.45		39747	W	A	S	NBR
54	85	10		39748	W	A	S	NBR
54	85	10		35508	W	A		NBR
54	85	10		17860	W	C		NBR
54	85	10		83176	W	A		FKM
54	85	15		17861	W	A		NBR
54	85	15		63324	W	A		FKM
54	90	10		22590	W	A		FKM
54	90	13		22591	W	A		FKM
54	90	13		20674	W	A		NBR
54	90	13		25725	W	C		NBR
54.1	77.72	15.87		42090	W	C	S	NBR
54.77	82.55	9.52		37311	W	A		NBR
54.99	81.99	11.99		59711	W	A		NBR
55	63	5		61089	W	B	O	NBR
55	63	5		85465	W	B	O	FKM
55	63	5		34476	W	A	O	FKM
55	63	5		22096	W	A	OK	NBR
55	65	5		42092	W	B	O	NBR
55	65	8		44797	W	A		NBR
55	65.7	7.1		40965	W	A		NBR
55	67	5		42093	W	B	O	NBR
55	67	12		40966	W	A	S	NBR
55	68	8		17863	W	A	S	NBR
55	68	8		83177	W	A		FKM
55	68	8		18696	W	A		NBR
55	68	8		17862	W	B		NBR
55	68	8		160586	W	A		NBR
55	68.5	7.5		40967	W	A		NBR
55	70	6		40968	W	A	OK	NBR
55	70	6		90378	W	A	S	NBR
55	70	7		120658	W	A	SY	NBR
55	70	7		148479	W	A		FKM
55	70	7		64231	W	A		NBR
55	70	8		47561	W	A	SY	NBR
55	70	8		22522	W	A	S	FKM
55	70	8		130807	W	A		FKM
55	70	8		48654	W	A	SY	FKM
55	70	8		20387	W	A		FKM
55	70	8		17864	W	A		NBR
55	70	8		40205	W	B	S	NBR
55	70	8		17865	W	A	S	NBR
55	70	8		17866	W	B		NBR
55	70	9		40499	W	B	O	NBR
55	70	9		19348	W	A		NBR
55	70	9		49517	W	C		NBR
55	70	9		39749	W	A	S	NBR
55	70	10		17867	W	A		NBR
55	70	10		17869	W	C		NBR
55	70	10		38950	W	A	S	FKM
55	70	10		19349	W	A	S	NBR

Any seal. Any time.

www.dichtomatik.de



d1	d2	H	H2	产品编码	产品组	设计型号	形式	材质
55	70	10		17868	W	B		NBR
55	70	10		20388	W	A		FKM
55	70	12		17870	W	C		NBR
55	70.8	4		42095	W	B	O	NBR
55	72	7		19785	W	A	O	NBR
55	72	7		48655	W	A	SY	FKM
55	72	7		39750	W	A	S	NBR
55	72	7		36816	W	A	SY	NBR
55	72	7		37269	W	A		NBR
55	72	7		81569	W	A	SY	NBR
55	72	8		56811	W	A	S	FKM
55	72	8		17871	W	A		NBR
55	72	8		134888	W	A	SY	FKM
55	72	8		18484	W	B		NBR
55	72	8		20389	W	A		FKM
55	72	8		32409	W	A	SY	NBR
55	72	8		19350	W	A	S	NBR
55	72	9		40206	W	B	S	NBR
55	72	9		19351	W	A	S	NBR
55	72	10		17875	W	C		NBR
55	72	10		17872	W	A		NBR
55	72	10		17874	W	B		NBR
55	72	10		17873	W	A	S	NBR
55	72	10		20390	W	A		FKM
55	72	10		44047	W	B	S	NBR
55	72	10		22523	W	A	S	FKM
55	72	12		17876	W	B		NBR
55	72	12		17877	W	C		NBR
55	72	12		49538	W	B		FKM
55	72	12		40397	W	C	S	NBR
55	72	12		39751	W	A	S	NBR
55	72	12		38563	W	A		NBR
55	72	12		179156	W	A	S	FKM
55	72	13		26411	W	A		NBR
55	72.5	9		40969	W	A		NBR
55	73	10		39050	W	B	S	NBR
55	73.1	10		39752	W	A	S	NBR
55	74	6		42094	W	B	O	NBR
55	74	10		39754	W	A	S	NBR
55	75	7		133594	W	A	SY	FKM
55	75	7		157278	W	A	SY	NBR
55	75	8		62534	W	A	S	FKM
55	75	8		79891	W	A	S	NBR
55	75	8		36701	W	A		FKM
55	75	8		19352	W	A		NBR
55	75	9		40207	W	B	S	NBR
55	75	9		19353	W	A	S	NBR
55	75	10		17879	W	C		NBR
55	75	10		38670	W	B		NBR
55	75	10		40208	W	B	S	NBR
55	75	10		17878	W	A		NBR
55	75	10		37093	W	A	S	NBR
55	75	10		20391	W	A		FKM
55	75	10		63299	W	A	S	FKM
55	75	10		133901	W	A	SY	NBR



油封

尺寸



油封

尺寸



d1	d2	H	H2	产品编码	产品组	设计型号	形式	材质
55	75	10		131085	W	A	S	NBR
55	75	12		40970	W	A	O	NBR
55	75	12		17882	W	C		NBR
55	75	12		42096	W	B	S	NBR
55	75	12		22592	W	A		FKM
55	75	12		17880	W	A		NBR
55	75	12		17881	W	B		NBR
55	75	12		19354	W	A	S	NBR
55	75	12		135224	W	A	S	FKM
55	75	12		152497	W	A	SY	FKM
55	76	8		17883	W	A	S	NBR
55	76	12		17884	W	A	S	NBR
55	76.2	10		19756	W	C	S	NBR
55	77	10		40971	W	A	S	NBR
55	78	8		39755	W	A	S	NBR
55	78	8		19355	W	A		NBR
55	78	9		39756	W	A		NBR
55	78	9		40972	W	A	S	NBR
55	78	10		26112	W	A	S	NBR
55	78	10		17885	W	A		NBR
55	78	10		63303	W	A		FKM
55	78	12		17886	W	C		NBR
55	78	12		19357	W	A	S	NBR
55	78	12		129998	W	A	SY	NBR
55	78	12		19356	W	A		NBR
55	78	12		40209	W	B	S	NBR
55	78	12		83194	W	A	S	FKM
55	78	13		38722	W	C		NBR
55	80	5		83422	W	A		NBR
55	80	6		83423	W	A		NBR
55	80	8		68985	W	B	S	NBR
55	80	8		36550	W	A	S	NBR
55	80	8		18485	W	B		NBR
55	80	8		143308	W	A	SY	FKM
55	80	8		131056	W	A	S	FKM
55	80	8		130937	W	A	S	NBR
55	80	8		75272	W	C		NBR
55	80	8		17887	W	A		NBR
55	80	8		20392	W	A		FKM
55	80	8		36453	W	A	S	FKM
55	80	8		179615	W	A		NBR
55	80	10		17891	W	B	S	NBR
55	80	10		131050	W	A	S	FKM
55	80	10		17889	W	A	S	NBR
55	80	10		17892	W	C	S	NBR
55	80	10		17888	W	A		NBR
55	80	10		17890	W	B		NBR
55	80	10		56232	W	A	S	FKM
55	80	10		20393	W	A		FKM
55	80	10		17040	W	C		NBR
55	80	12		17894	W	B		NBR
55	80	12		40210	W	B	S	NBR
55	80	12		17893	W	A		NBR
55	80	12		104314	W	A		FKM
55	80	12		17895	W	C		NBR

Any seal. Any time.

www.dichtomatik.de



油封

尺寸

d1	d2	H	H2	产品编码	产品组	设计型号	形式	材质
55	80	12		39757	W	A	S	NBR
55	80	13		17899	W	C		NBR
55	80	13		61799	W	C	S	NBR
55	80	13		17898	W	B		NBR
55	80	13		20394	W	A		FKM
55	80	13		40973	W	A	S	NBR
55	80	13		17896	W	A		NBR
55	80	13		18644	W	B	S	NBR
55	80	13		107857	W	A	SY	NBR
55	82	9.35		40976	W	A	S	NBR
55	82	10		39758	W	A	S	NBR
55	82	10		40498	W	B	O	NBR
55	82	10		40211	W	B	S	NBR
55	82	12		40974	W	A	S	NBR
55	84	14		40975	W	A	S	NBR
55	85	8		39759	W	A	S	NBR
55	85	8		17900	W	A		NBR
55	85	8		130868	W	A		FKM
55	85	8		17901	W	B		NBR
55	85	8		26934	W	A		FKM
55	85	8		81506	W	B		NBR
55	85	10		62535	W	A		FKM
55	85	10		63326	W	A	S	FKM
55	85	10		26942	W	A	S	NBR
55	85	10		17902	W	A		NBR
55	85	10		17903	W	C		NBR
55	85	12		144060	W	A		NBR
55	85	12		19358	W	A	S	NBR
55	85	12		17904	W	C		NBR
55	85	13		17906	W	C		NBR
55	85	13		19359	W	B		NBR
55	85	13		20395	W	A		FKM
55	85	13		17043	W	B	S	NBR
55	85	13		17905	W	A		NBR
55	85	14		40212	W	B	S	NBR
55	85	16		17907	W	A		NBR
55	85	16		63327	W	A		FKM
55	88	10		40977	W	A	S	NBR
55	88	10		44270	W	A		NBR
55	88	12		40978	W	A	S	NBR
55	90	6		83947	W	B	O	NBR
55	90	7		168593	W	A	SY	FKM
55	90	8		40979	W	A	S	NBR
55	90	8		83424	W	A		NBR
55	90	8		173432	W	A	S	FKM
55	90	10		20396	W	A		FKM
55	90	10		63344	W	A	S	FKM
55	90	10		17908	W	A		NBR
55	90	10		130748	W	A		FKM
55	90	10		17909	W	A	S	NBR
55	90	10		131054	W	A	S	FKM
55	90	12		35576	W	A		NBR
55	90	12		39760	W	A	S	NBR
55	90	13		63345	W	A		FKM
55	90	13		17911	W	B		NBR





油封

尺寸



d1	d2	H	H2	产品编码	产品组	设计型号	形式	材质
55	90	13		17912	W	C		NBR
55	90	13		17910	W	A		NBR
55	90	19		163162	W	A		NBR
55	100	10		36667	W	A	S	NBR
55	100	10		39199	W	A		NBR
55	100	10		174739	W	A		FKM
85	110	12		163948	W	A	S	FKM
55	100	12		40980	W	A	S	NBR
55	100	12		26356	W	A		NBR
55	100	13		17913	W	C		NBR
55	100	13		34294	W	A		FKM
55	100	13		83425	W	A		NBR
55	100	16		17914	W	A		NBR
55	100	16		63357	W	A		FKM
55	120	12		48656	W	A		FKM
55.56	73.02	9.52		59894	W	A	S	NBR
55.56	73.02	9.52		21563	W	A		NBR
55.56	73.02	12.7		21860	W	A	S	NBR
55.56	76.2	9.52		59895	W	A	S	NBR
55.56	76.2	9.52		20933	W	A		NBR
55.56	76.2	12.7		20843	W	A		NBR
55.56	77.78	9.52		38485	W	C		NBR
55.56	77.79	9.52		75271	W	C		NBR
55.56	82.55	9.52		60561	W	B		NBR
55.56	82.55	9.52		59896	W	A	S	NBR
56	65	12		39763	W	A	S	NBR
56	66	8.5		165700	W	B	O	NBR
56	68	11		42097	W	B		NBR
56	69	10		37203	W	A		NBR
56	69	10		172450	W	A	S	NBR
				62536				
56	70	8			W	A	S	FKM
56	70	8		19360	W	A		NBR
56	70	8		39764	W	A	S	NBR
56	70	8		56812	W	A		FKM
56	70	9		19361	W	A	S	NBR
56	70	9.6		82393	W	A	S	NBR
56	70	12		40213	W	B	S	NBR
56	72	7		39765	W	A	S	NBR
56	72	8		17915	W	A		NBR
56	72	8		17916	W	B		NBR
56	72	8		62537	W	A	S	FKM
56	72	8		20397	W	A		FKM
56	72	8		18645	W	B	S	NBR
56	72	9		39766	W	A	S	NBR
56	72	9		26412	W	A		NBR
56	72	10		60364	W	B	S	NBR
56	72	10		63292	W	A		FKM
56	72	10		17917	W	A		NBR
56	72	10		38721	W	C		NBR
56	72	12.5		39767	W	A	S	NBR
56	73.15	10		19857	W	B	S	NBR
56	73.15	10		39768	W	A	S	NBR
56	74	10		39770	W	A	S	NBR
56	76	11		63302	W	A		FKM
56	76	11		17918	W	A		NBR

Any seal. Any time.

www.dichtomatik.de



d1	d2	H	H2	产品编码	产品组	设计型号	形式	材质
56	80	8		19362	W	A		NBR
56	80	8		60365	W	A	S	NBR
56	80	8		62538	W	A		FKM
56	80	10		19757	W	C		NBR
56	80	12		22593	W	A		FKM
56	80	12		19363	W	A	S	NBR
56	80	13		38720	W	C		NBR
56	85	8		36884	W	A		FKM
56	85	8		19364	W	A		NBR
56	85	8		64977	W	A	S	NBR
56	85	10		56399	W	C		NBR
56	85	13		39771	W	A	S	NBR
56	85	13		19365	W	A		NBR
56	86	13		19366	W	A	S	NBR
56	88	10		17919	W	A		NBR
56	88	10		63339	W	A		FKM
56	88	13		17920	W	A		NBR
56	88	13		63340	W	A		FKM
56	90	10		71719	W	A		FKM
56	90	10		56290	W	A		NBR
56	90	13		17922	W	C		NBR
56	90	13		40981	W	A	S	NBR
56	90	13		17921	W	B		NBR
56	100	10		40982	W	A	S	NBR
56	100	10		38753	W	A		NBR
56	100	12		19367	W	A	S	NBR
56.48	84.93	13		49470	W	A		NBR
57	67	7		39772	W	A	S	NBR
57	67.5	6		40983	W	A		NBR
57	72	10		40398	W	C		NBR
57	72	10		40984	W	A		NBR
57	72	12		40214	W	B	S	NBR
57	73	7		39773	W	A	S	NBR
57	73.5	14		42099	W	B		NBR
57	75	7.5		72779	W	A	S	NBR
57	75	9		42101	W	B		NBR
57	75	10		39774	W	A		NBR
57	75	12		19368	W	A		NBR
57	76	12.5		40985	W	A		NBR
57	78	12		40986	W	A		NBR
57	79.5	10		39775	W	A	S	NBR
57	80	12		78268	W	A	S	NBR
57	80	12		40399	W	C		NBR
57	80	12		115754	W	A		NBR
57	80	13		40987	W	A		NBR
57	82.6	12.8		42100	W	B	S	NBR
57	82.7	10		49503	W	A		NBR
57	85	10		39776	W	A		NBR
57	85	12		39777	W	A	S	NBR
57	85	13		63328	W	A	S	FKM
57	85	13		17923	W	A		NBR
57	85	13		17924	W	C		NBR
57	85	13		38801	W	A	S	NBR
57	86	13		19369	W	A	S	NBR
57	87	15		69272	W	A		NBR



油封

尺寸



油封

尺寸



d1	d2	H	H2	产品编码	产品组	设计型号	形式	材质
57	88	13.5		40989	W	A	S	NBR
57	89	13.5		40988	W	A	S	NBR
57	90	13		19370	W	A		NBR
57	90	13		17925	W	C		NBR
57	95	10		26413	W	A		NBR
57.15	69.85	9.52		59897	W	A	S	NBR
57.15	73.02	7.93		40500	W	B	O	NBR
57.15	73.02	9.52		35308	W	B		NBR
57.15	73.02	9.52		20140	W	A		NBR
57.15	74.42	12.7		38486	W	C		NBR
57.15	76.2	9.52		56285	W	A	S	NBR
57.15	76.2	9.52		60718	W	B	S	NBR
57.15	76.2	9.52		20141	W	A		NBR
57.15	76.2	9.52		60562	W	B		NBR
57.15	76.2	11.11		49504	W	C		NBR
57.15	76.2	11.11		40990	W	A	S	NBR
57.15	76.2	11.11		60719	W	B	S	NBR
57.15	76.2	12.7		158746	W	A		FKM
57.15	76.2	12.7		19965	W	A		NBR
57.15	76.2	12.7		60563	W	B		NBR
57.15	76.2	12.7		60855	W	C		NBR
57.15	76.2	12.7		75273	W	C	S	NBR
57.15	77.78	11.11		59712	W	A		NBR
57.15	77.78	11.11		80736	W	C		NBR
57.15	77.88	11.91		42640	W	A		NBR
57.15	79.37	9.52		20845	W	A		NBR
57.15	79.37	9.52		59898	W	A	S	NBR
57.15	79.38	9.65		48739	W	C		NBR
57.15	80.96	11.11		60720	W	B	S	NBR
57.15	80.96	11.11		60856	W	C		NBR
57.15	80.96	12.7		20817	W	A		NBR
57.15	82.55	11.11		59899	W	A	S	NBR
57.15	82.55	12.7		56813	W	A		FKM
57.15	82.55	12.7		20818	W	A		NBR
57.15	82.55	12.7		60564	W	B		NBR
57.15	82.55	12.7		60857	W	C		NBR
57.15	85.09	7.93		60565	W	B		NBR
57.15	85.09	11.11		60858	W	C		NBR
57.15	85.09	11.9		83470	W	C		NBR
57.15	85.09	15.08		42098	W	B	S	NBR
57.15	85.72	9.52		60769	W	B	O	NBR
57.15	85.72	9.52		60721	W	B	S	NBR
57.15	85.72	9.52		35716	W	A		NBR
57.15	85.72	9.92		59713	W	A		NBR
57.15	85.72	12.7		59900	W	A	S	NBR
57.15	85.72	12.7		60722	W	B	S	NBR
57.15	85.72	12.7		60724	W	B		NBR
57.15	85.72	12.7		19869	W	A		NBR
57.15	87.38	6.35		60770	W	B	O	NBR
57.15	88.9	12.7		59901	W	A	S	NBR
57.15	88.9	12.7		20142	W	A		NBR
57.15	92.07	11.11		21143	W	C		NBR
57.15	92.07	12.7		20820	W	A		NBR
57.15	129.78	9.52		37627	W	A	S	NBR
57.15	130	9.52		35052	W	A		NBR

Any seal. Any time.

www.dichtomatik.de



d1	d2	H	H2	产品编码	产品组	设计型号	形式	材质
57.35	79.37	9.52		59902	W	A	S	NBR
57.91	76.2	9.65		158275	W	B	S	NBR
57.94	84.93	7.93		56983	W	A		NBR
58	65	3.5		132700	W	B	O	NBR
58	68	9		39778	W	A	S	NBR
58	70	6		73091	W	A		NBR
58	70	8		84202	W	B		NBR
58	72	7		40993	W	A		NBR
58	72	8		40400	W	C		NBR
58	72	8		17926	W	A		NBR
58	72	8		19371	W	B	S	NBR
58	72	8		20398	W	A		FKM
58	72	8		39779	W	A	S	NBR
58	72	8		17927	W	B		NBR
58	72	9		19373	W	A	S	NBR
58	72	9		19372	W	A		NBR
58	72	10		152909	W	A	S	FKM
58	72	10		130960	W	A	S	NBR
58	72	10		56814	W	A		FKM
58	72	12		19374	W	A	S	NBR
58	74	10		39780	W	A	S	NBR
58	75	5		40991	W	A		NBR
58	75	8		17928	W	B		NBR
58	75	8		22594	W	A		FKM
58	75	9		19376	W	A	S	NBR
58	75	9		19375	W	A		NBR
58	75	10		40992	W	A		NBR
58	75	10		62961	W	B		NBR
58	75	12		26414	W	A		NBR
58	75	12		17929	W	C		NBR
58	75	12		39781	W	A	S	NBR
58	75	13		19377	W	A	S	NBR
58	76	7		134628	W	A		NBR
58	76	9		26415	W	A		NBR
58	76	13		19378	W	A	S	NBR
58	78	13		56815	W	A		FKM
58	78	13		17259	W	A		NBR
58	78	13		40401	W	C		NBR
58	80	8		17930	W	A		NBR
58	80	8		20629	W	B	S	NBR
58	80	8		19379	W	A	S	NBR
58	80	8		22524	W	A	S	FKM
58	80	8		22595	W	A		FKM
58	80	9		20470	W	A		FKM
58	80	9		175587	W	A	S	NBR
58	80	9		19380	W	A	S	NBR
58	80	9		22238	W	A	S	FKM
58	80	10		17931	W	A		NBR
58	80	10		44289	W	B		NBR
58	80	10		17932	W	C		NBR
58	80	10		38061	W	A	S	NBR
58	80	10		157303	W	A	SY	NBR
58	80	10		92170	W	A	SY	FKM
58	80	10		20399	W	A		FKM
58	80	12		19382	W	A	S	NBR



油封

尺寸



油封

尺寸



d1	d2	H	H2	产品编码	产品组	设计型号	形式	材质
58	80	12		19381	W	A		NBR
58	80	12		129999	W	A	SY	NBR
58	80	12		17933	W	C		NBR
58	80	13		19383	W	A	S	NBR
58	80	13		44231	W	A		NBR
58	80	13		38719	W	C		NBR
58	82	12		19384	W	A	S	NBR
58	85	10		17934	W	A		NBR
58	85	10		17935	W	B		NBR
58	85	10		17936	W	C		NBR
58	85	10		40994	W	A	S	NBR
58	85	10		63329	W	A		FKM
58	85	12		19385	W	A		NBR
58	85	13		63330	W	A		FKM
58	85	13		17937	W	A		NBR
58	85	13		17938	W	C		NBR
58	86	14		63338	W	A		FKM
58	86	14		19823	W	A		NBR
58	90	8		40995	W	A	S	NBR
58	90	10			W	A		FKM
58	90	10		63346				
58	90	10		61783	W	A	S	NBR
58	90	10		17939	W	A		NBR
58	90	11		19386	W	A		NBR
58	90	11		19387	W	A	S	NBR
58	90	13		19388	W	B		NBR
58	90	13		17940	W	C		NBR
58	90	13		44249	W	A		NBR
58	102	12		40215	W	B	S	NBR
58.73	76.2	6.35		60771	W	B	O	NBR
58.73	77.78	9.52		9431	W	A		NBR
58.73	79.37	9.52		20815	W	A		NBR
58.73	79.37	9.52		60723	W	B	S	NBR
58.73	79.5	9.52		60568	W	B		NBR
58.73	84.93	7.93		20225	W	B		NBR
58.73	85.09	7.93		59903	W	A	S	NBR
58.73	85.09	7.93		60725	W	B	S	NBR
58.73	85.09	7.93		59714	W	A		NBR
58.73	85.09	7.93		60566	W	B		NBR
58.73	85.22	7.93		40402	W	C		NBR
58.73	85.32	7.93		60567	W	B		NBR
58.73	85.32	7.93		20248	W	A		NBR
58.73	85.72	9.52		59904	W	A	S	NBR
58.73	85.72	9.52		59715	W	A		NBR
58.73	88.9	12.7		60859	W	C		NBR
59	72	12		60345	W	B	S	NBR
59	80	10		24442	W	A		NBR
59	85	8		19389	W	A		NBR
59	85	19		42103	W	B	S	NBR
59.92	85.72	12.7		60726	W	B	S	NBR
59.97	129.99	9.52		59716	W	A		NBR
60	67	4		79603	W	B	O	NBR
60	67	4		162209	W	B	O	NBR
60	70	7		69627	W	B		NBR
60	70	7		38443	W	A		NBR
60	70	10		21504	W	A	O	NBR

Any seal. Any time.

www.dichtomatik.de



d1	d2	H	H2	产品编码	产品组	设计型号	形式	材质
60	70	13.5		40996	W	A	O	NBR
60	72	4		49315	W	A	OK	NBR
60	72	7		82238	W	B		NBR
60	72	7		118701	W	A	SY	NBR
60	72	7.5		40216	W	B		NBR
60	72	8		19390	W	A		NBR
60	72	8		73233	W	A		FKM
60	72	8		39251	W	A	S	NBR
60	72	8		17941	W	B		NBR
60	72	8.5		39782	W	A		NBR
60	72	12		39783	W	A	S	NBR
60	74	7.5		40217	W	B		NBR
60	74	8		19861	W	B		NBR
60	74	10		19862	W	A		NBR
60	74	10		179149	W	A	S	NBR
60	75	5		42535	W	B	O	NBR
60	75	6		42536	W	B	O	NBR
60	75	7		64232	W	A		NBR
60	75	7		84884	W	B		NBR
60	75	8		17942	W	A		NBR
60	75	8		17943	W	B		NBR
60	75	8		20400	W	A		FKM
60	75	8		38718	W	C		NBR
60	75	8		22525	W	A	S	FKM
60	75	8		133889	W	A	SY	FKM
60	75	8		40218	W	B	S	NBR
60	75	8		18476	W	A	S	NBR
60	75	8		127197	W	A	SY	NBR
60	75	8		162125	W	A	S	NBR
60	75	9		19393	W	A	S	NBR
60	75	9		19392	W	A		NBR
60	75	10		39784	W	A	S	NBR
60	75	10		42537	W	B	O	NBR
60	75	10		151001	W	A	S	FKM
60	75	10		150316	W	B	S	NBR
60	75	10		22596	W	A		FKM
60	75	10		44232	W	A		NBR
60	75	10		157304	W	A	SY	NBR
60	75	12		17944	W	A		NBR
60	75	12		17945	W	C		NBR
60	75	12		40997	W	A	S	NBR
60	75	12		63300	W	A		FKM
60	75.4	10		40998	W	A	S	NBR
60	76	10		39785	W	A		NBR
60	77	12		39786	W	A	S	NBR
60	77	12		40219	W	B	S	NBR
60	78	7		40501	W	B	O	NBR
60	78	7		40999	W	A		NBR
60	78	9		19395	W	A	S	NBR
60	78	9		121712	W	A	S	FKM
60	78	9		19394	W	A		NBR
60	78	10		35753	W	A		FKM
60	78	10		39788	W	A		NBR
60	78	10		39787	W	A	S	NBR
60	78	10		40502	W	B	O	NBR



油封

尺寸



油封

尺寸



d1	d2	H	H2	产品编码	产品组	设计型号	形式	材质
60	78	12		41000	W	A	S	NBR
60	78	13		40898	W	A		NBR
60	78	13		39065	W	C		NBR
60	80	4		41001	W	A	O	NBR
60	80	7		22526	W	A	S	FKM
60	80	7		17946	W	A	S	NBR
60	80	7		24353	W	A	SY	NBR
60	80	7		80302	W	A	SY	FKM
60	80	7		69612	W	A		NBR
60	80	8		36454	W	A	S	FKM
60	80	8		130782	W	A		FKM
60	80	8		75274	W	C	S	NBR
60	80	8		171317	W	A	S	FKM
60	80	8		17947	W	A		NBR
60	80	8		18486	W	B		NBR
60	80	8		38487	W	C		NBR
60	80	8		36551	W	A	S	NBR
60	80	8		19396	W	B	S	NBR
60	80	8		20401	W	A		FKM
60	80	9		17948	W	A	S	NBR
60	80	9		63312	W	A	S	FKM
60	80	9		19397	W	A		NBR
60	80	10		17949	W	A		NBR
60	80	10		21156	W	A	S	FKM
60	80	10		130935	W	A	S	NBR
60	80	10		126559	W	B		FKM
60	80	10		17950	W	A	S	NBR
60	80	10		17952	W	C		NBR
60	80	10		130987	W	A	S	FKM
60	80	10		17951	W	B		NBR
60	80	10		20402	W	A		FKM
60	80	10		38689	W	B	S	NBR
60	80	10		177173	W	A	S	NBR
60	80	10		130847	W	A		FKM
60	80	10		159253	W	A	S	NBR
60	80	12		19398	W	A	S	NBR
60	80	12		40220	W	B	S	NBR
60	80	12		17954	W	B		NBR
60	80	12		39761	W	A		FKM
60	80	12		19990	W	C	S	NBR
60	80	12		21666	W	A	S	FKM
60	80	12		17955	W	C		NBR
60	80	12		17953	W	A		NBR
60	80	13		17956	W	A		NBR
60	80	13		63313	W	A		FKM
60	80	13		40221	W	B	S	NBR
60	80	13		39789	W	A	S	NBR
60	80	13		17957	W	B		NBR
60	80	13		17958	W	C		NBR
60	82	7		39790	W	A	S	NBR
60	82	9		19399	W	A	S	NBR
60	82	9		39791	W	A		NBR
60	82	10		40222	W	B	S	NBR
60	82	10		41002	W	A	S	NBR
60	82	12		19400	W	A		NBR

Any seal. Any time.

www.dichtomatik.de



d1	d2	H	H2	产品编码	产品组	设计型号	形式	材质
60	82	12		130000	W	A	SY	NBR
60	82	12		44359	W	C	S	NBR
60	82	12		39792	W	A	S	NBR
60	82	12		42538	W	B		NBR
60	82	13		42540	W	B	S	NBR
60	85	8		56817	W	A		FKM
60	85	8		38717	W	C		NBR
60	85	8		131072	W	A	S	FKM
60	85	8		39793	W	A	S	NBR
60	85	8		40223	W	B	S	NBR
60	85	8		12252	W	A	SY	NBR
60	85	8		17959	W	A		NBR
60	85	8		83195	W	A	S	FKM
60	85	8		17960	W	B		NBR
60	85	10		17962	W	A	S	NBR
60	85	10		17963	W	C		NBR
60	85	10		130845	W	A		FKM
60	85	10		17961	W	A		NBR
60	85	10		21157	W	A	S	FKM
60	85	10		20403	W	A		FKM
60	85	12		39794	W	A	S	NBR
60	85	12		17964	W	C		NBR
60	85	12		19401	W	A		NBR
60	85	13		19402	W	A		NBR
60	85	13		38690	W	B	S	NBR
60	85	13		63331	W	A		FKM
60	85	13		39795	W	A	S	NBR
60	85	13		19739	W	C		NBR
60	85	13		18487	W	B		NBR
60	85	18		42539	W	B	S	NBR
60	85.1	12		48740	W	C		NBR
60	88	14		39796	W	A	S	NBR
60	88	14		41003	W	A	S	NBR
60	89	11		17965	W	A		NBR
60	90	7		47915	W	A	SY	NBR
60	90	8		35517	W	A		FKM
60	90	8		17967	W	B		NBR
60	90	8		62539	W	A	S	FKM
60	90	8		17966	W	A		NBR
60	90	8		35043	W	A	S	NBR
60	90	10		19738	W	B		NBR
60	90	10		19740	W	B	S	NBR
60	90	10		19404	W	C		NBR
60	90	10		17968	W	A		NBR
60	90	10		56818	W	A	S	FKM
60	90	10		17969	W	A	S	NBR
60	90	10		20404	W	A		FKM
60	90	11		19405	W	A	S	NBR
60	90	12		17971	W	C		NBR
60	90	12		17970	W	B		NBR
60	90	13		17974	W	B	S	NBR
60	90	13		17975	W	C		NBR
60	90	13		20405	W	A		FKM
60	90	13		17972	W	A		NBR
60	90	13		39797	W	A	S	NBR



油封

尺寸



油封

尺寸



d1	d2	H	H2	产品编码	产品组	设计型号	形式	材质
60	90	13		17973	W	B		NBR
60	90	16		41004	W	A	S	NBR
60	91	16		41005	W	A	S	NBR
60	92	11		19406	W	A		NBR
60	93	13		44250	W	A		NBR
60	95	8		89800	W	A		NBR
60	95	8		75032	W	A	S	NBR
60	95	10		130800	W	A		FKM
60	95	10		176503	W	A		FKM
60	95	10		19407	W	A	S	NBR
60	95	10		20406	W	A		FKM
60	95	10		157166	W	A	S	FKM
60	95	10		17976	W	A		NBR
60	95	10		17977	W	C		NBR
60	95	12		39798	W	A	S	NBR
60	95	13		17978	W	C		NBR
60	95	13		39799	W	A	S	NBR
60	100	10		63358	W	A		FKM
60	100	10		172703	W	A	S	FKM
60	100	10		130022	W	A	S	NBR
60	100	10		17979	W	A		NBR
60	100	12		17980	W	C		NBR
60	100	13		17982	W	C		NBR
60	100	13		63449	W	A		FKM
60	100	13		17981	W	A		NBR
60	104	12		39800	W	A	S	NBR
60	110	4		41006	W	A	O	NBR
60	110	8		155710	W	A	S	NBR
60	110	10		39801	W	A	S	NBR
60	110	12		63464	W	A		FKM
60	110	12		17983	W	A		NBR
60	110	13		56819	W	A		FKM
60	110	13		75276	W	C		NBR
60	110	13		19586	W	A		NBR
60	110	13		153268	W	A	S	NBR
60	120	12		133549	W	A		NBR
60	130	10		59905	W	A	S	NBR
60	130	12		48657	W	A		FKM
60	130	15		44545	W	A		NBR
60	140	15		172696	W	A	S	FKM
60.02	88.9	12.7		75275	W	C		NBR
60.32	69.85	7.93		20143	W	A		NBR
60.32	73.02	7.93		59906	W	A	S	NBR
60.32	73.02	7.93		19962	W	A		NBR
60.32	73.02	9.52		59907	W	A	S	NBR
60.32	76.2	9.52		59908	W	A	S	NBR
60.32	76.2	9.52		20144	W	A		NBR
60.32	76.2	9.52		60569	W	B		NBR
60.32	79.37	9.52		59909	W	A	S	NBR
60.32	79.37	9.52		79690	W	A	S	FKM
60.32	79.37	9.52		20145	W	A		NBR
60.32	79.37	9.52		60570	W	B		NBR
60.32	79.37	12.7		42541	W	B	S	NBR
60.32	79.48	9.52		39802	W	A		NBR
60.32	79.5	10		42542	W	B	S	NBR

Any seal. Any time.

www.dichtomatik.de



d1	d2	H	H2	产品编码	产品组	设计型号	形式	材质
60.32	79.53	9.52		60347	W	B		NBR
60.32	82.55	9.52		59910	W	A	S	NBR
60.32	82.55	12.7		20146	W	A		NBR
60.32	85.09	11.11		60727	W	B	S	NBR
60.32	85.09	11.11		157000	W	C	S	NBR
60.32	85.72	9.52		59911	W	A	S	NBR
60.32	85.72	11.11		60896	W	C	S	NBR
60.32	85.72	12.7		60571	W	B		NBR
60.32	85.72	12.7		59912	W	A	S	NBR
60.32	85.72	12.7		20147	W	A		NBR
60.32	86.38	11.11		60860	W	C		NBR
60.32	88.4	11.11		60861	W	C		NBR
60.32	88.4	11.11		60897	W	C	S	NBR
60.32	88.9	9.52		60898	W	C	S	NBR
60.32	88.9	9.52		20148	W	A		NBR
60.32	88.9	9.52		60572	W	B		NBR
60.32	88.9	11.11		56409	W	A		NBR
60.32	88.9	12.7		60573	W	B		NBR
60.32	88.9	12.7		61763	W	A		NBR
60.32	88.9	12.7		59913	W	A	S	NBR
60.32	88.9	12.7		20149	W	A		NBR
60.32	92.07	12.7		40503	W	C		NBR
60.32	92.07	12.7		20821	W	A		NBR
60.32	98.42	11.91		60862	W	C		NBR
60.33	88.9	12.7		47912	W	A	S	NBR
60.5	78	9		39803	W	A	S	NBR
60.5	78	9		41007	W	A		NBR
61	75	8		40224	W	B		NBR
61	75	8		61337	W	A		FKM
61	80	13		17984	W	A		NBR
61	80	13		63314	W	A		FKM
61	82.5	13		41008	W	A		NBR
61	85	10		39804	W	A	S	NBR
61	85	13		19741	W	B	S	NBR
61	85	13		17985	W	C		NBR
61.91	77.78	12.7		59717	W	A		NBR
61.91	82.55	9.52		20150	W	A		NBR
61.91	85.72	12.7		59914	W	A	S	NBR
61.91	85.72	12.7		20151	W	A		NBR
61.91	88.9	9.52		41540	W	A		FKM
61.91	95.73	12.7		56820	W	A		FKM
61.91	100.4	12.7		36627	W	A		NBR
62	70	10		20675	W	A	OK	NBR
62	72	9		19408	W	A	S	NBR
62	72	10		75828	W	A	S	NBR
62	74	5		151902	W	B	O	NBR
62	75	7.5		90494	W	A	SY	NBR
62	75	10		38716	W	C		NBR
62	75	10		38671	W	B		NBR
62	76	10		83178	W	A		FKM
62	80	9		19409	W	A	S	NBR
62	80	9		84443	W	A	S	NBR
62	80	10		19410	W	A		NBR
62	80	10		17987	W	C		NBR
62	80	10		40226	W	B	S	NBR



油封

尺寸



油封

尺寸



d1	d2	H	H2	产品编码	产品组	设计型号	形式	材质
62	80	10		73234	W	A		FKM
62	80	10		17986	W	B		NBR
62	80	10		41009	W	A	S	NBR
62	80	12		17989	W	C		NBR
62	80	12		63315	W	A		FKM
62	80	12		17988	W	A		NBR
62	80	12		39807	W	A	S	NBR
62	80	16		6449	W	C	S	NBR
62	81	6		178893	W	A		NBR
62	81	6		115562	W	A	S	NBR
62	82	10		81258	W	A		NBR
62	82	10		39808	W	A	S	NBR
62	82	10		72519	W	C		NBR
62	82	12		39809	W	A	S	NBR
62	82.5	9.7		41010	W	A	S	NBR
62	83	9		39810	W	A	S	NBR
62	85	7		79697	W	A	SY	NBR
62	85	7		128173	W	A	SY	FKM
62	85	8		40227	W	B	S	NBR
62	85	8		39811	W	A	S	NBR
62	85	8		40225	W	B		NBR
62	85	8		130159	W	A		NBR
62	85	9.5		41011	W	A		NBR
62	85	10		17990	W	A		NBR
62	85	10		17992	W	C		NBR
62	85	10		39812	W	A	S	NBR
62	85	10		20407	W	A		FKM
62	85	10		39066	W	C	S	NBR
62	85	10		161823	W	A	S	NBR
62	85	10		17991	W	B		NBR
62	85	12		130001	W	A	SY	NBR
62	85	12		17993	W	C		NBR
62	85	12		20749	W	A		FKM
62	85	12		19411	W	A	S	NBR
62	85	12		24440	W	A		NBR
62	85	13		17994	W	A		NBR
62	85	13		42543	W	C	S	NBR
62	85	13		39813	W	A	S	NBR
62	85	13		42544	W	B	S	NBR
62	85	13		63332	W	A		FKM
62	85	13		17995	W	C		NBR
62	90	10		62540	W	A		FKM
62	90	10		17996	W	A		NBR
62	90	10		17997	W	B		NBR
62	90	10		17998	W	C		NBR
62	90	10		39814	W	A	S	NBR
62	90	11		63347	W	A		FKM
62	90	11		17999	W	A		NBR
62	90	12		18000	W	C		NBR
62	90	12		39815	W	A	S	NBR
62	90	13		44290	W	B		NBR
62	90	13		19412	W	A		NBR
62	92	12		41012	W	A	S	NBR
62	95	10		39816	W	A		NBR
62	95	13		41013	W	A	S	NBR

Any seal. Any time.

www.dichtomatik.de



d1	d2	H	H2	产品编码	产品组	设计型号	形式	材质
62	100	10		18001	W	A		NBR
62	100	10		63450	W	A		FKM
62	100	12		18002	W	A		NBR
62	100	13		18003	W	C		NBR
62	100	13		42545	W	C	S	NBR
62	101	15		19413	W	A	S	NBR
62	110	10		134605	W	A	S	NBR
62	111	7.5		72953	W	A		NBR
62.7	82.55	9.52		157001	W	B	S	NBR
62.7	89	13.8		163164	W	B		NBR
63	73	5		68269	W	A	O	NBR
63	75	5		41014	W	A	O	NBR
63	75	6		42546	W	B	S	NBR
63	75	9		39817	W	A	S	NBR
63	80	9		19414	W	A	S	NBR
63	85	8		41015	W	A	S	NBR
63	85	10		22527	W	A	S	FKM
63	85	10		56472	W	C		NBR
63	85	10		56587	W	C	S	NBR
63	85	10		20471	W	A		FKM
63	85	10		19415	W	A		NBR
63	85	10		19416	W	A	S	NBR
63	85	12		18004	W	C		NBR
63	85	12		39818	W	A	S	NBR
63	85	12		39819	W	A		NBR
63	85	13		44251	W	A		NBR
63	88	10		18005	W	A		NBR
63	88	10		39820	W	A	S	NBR
63	90	10		19417	W	A		NBR
63	90	10		62541	W	A		FKM
63	90	10		62542	W	A	S	FKM
63	90	10		39821	W	A	S	NBR
63	90	13		56048	W	C		NBR
63	100	10		179526	W	A	S	NBR
63	100	13		18006	W	A		NBR
63	110	12		41016	W	A		NBR
63.5	73.02	6.35		55947	W	A		FKM
63.5	76.2	9.52		56729	W	A		NBR
63.5	76.2	12.7		20152	W	A		NBR
63.5	77.78	10.9		59718	W	A		NBR
63.5	77.78	11.11		80172	W	A		NBR
63.5	79.37	6.35		20153	W	A		NBR
63.5	79.37	12.7		60574	W	B		NBR
63.5	80.16	7.93		36622	W	B		NBR
63.5	80.96	9.52		59719	W	A		NBR
63.5	80.96	9.52		59915	W	A	S	NBR
63.5	80.96	11.11		60863	W	C		NBR
63.5	82	12		39822	W	A	S	NBR
63.5	82.55	9.52		20154	W	A		NBR
63.5	82.55	9.52		59916	W	A	S	NBR
63.5	82.55	9.52		42547	W	B		NBR
63.5	82.55	9.52		73235	W	A		FKM
63.5	82.55	10.5		41018	W	A	S	NBR
63.5	82.55	11.11		60899	W	C	S	NBR
63.5	82.55	12.7		20155	W	A		NBR



油封

尺寸



油封

尺寸



d1	d2	H	H2	产品编码	产品组	设计型号	形式	材质
63.5	82.55	12.7		40455	W	C		NBR
63.5	82.55	12.7		60575	W	B		NBR
63.5	82.7	15		42549	W	B	S	NBR
63.5	85	12		39823	W	A	S	NBR
63.5	85	13		39824	W	A	S	NBR
63.5	85.72	6.35		47925	W	A	S	NBR
63.5	85.72	9.52		42550	W	C		NBR
63.5	85.72	12.7		59917	W	A	S	NBR
63.5	85.72	12.7		36207	W	C	S	NBR
63.5	85.72	12.7		20156	W	A		NBR
63.5	88.9	6.9		157008	W	C	O	NBR
63.5	88.9	9.52		60577	W	B		NBR
63.5	88.9	9.52		19995	W	A		NBR
63.5	88.9	9.52		39185	W	A	S	NBR
63.5	88.9	10.32		60578	W	B		NBR
63.5	88.9	11.11		56825	W	A		FKM
63.5	88.9	11.11		60864	W	C		NBR
63.5	88.9	11.11		60900	W	C	S	NBR
63.5	88.9	12.7		60580	W	B		NBR
63.5	88.9	12.7		20249	W	A		NBR
63.5	88.9	12.7		60901	W	C	S	NBR
63.5	88.9	12.7		59918	W	A	S	NBR
63.5	88.9	15.87		41179	W	A		NBR
63.5	88.9	19.05		59919	W	A	S	NBR
63.5	89.9	12.7		60581	W	B		NBR
63.5	90	13		63348	W	A		FKM
63.5	90	13		18008	W	A		NBR
63.5	90.09	12.7		39825	W	A	S	NBR
63.5	90.88	12.7		59920	W	A	S	NBR
63.5	92.07	9.52		79689	W	A	S	FKM
63.5	92.07	11.91		60865	W	C		NBR
63.5	92.07	12.7		20157	W	A		NBR
63.5	94	14		42548	W	C		NBR
63.5	95	14		41019	W	A	S	NBR
63.5	95.25	9.52		69713	W	A	S	FKM
63.5	95.25	11.11		60866	W	C		NBR
63.5	95.25	12.7		59922	W	A	S	NBR
63.5	95.25	12.7		20158	W	A		NBR
63.5	95.25	12.7		60582	W	B		NBR
63.5	95.25	12.7		60902	W	C	S	NBR
63.5	98.42	6.35		20159	W	A		NBR
63.5	98.42	12.7		20160	W	A		NBR
63.5	100	9.52		37628	W	A	S	NBR
63.5	100	9.52		35522	W	A		NBR
63.5	114.3	12.7		61760	W	A	S	NBR
64	80	7		43962	W	A		NBR
64	80	8		18010	W	B		NBR
64	80	8		18011	W	B	S	NBR
64	80	8		63316	W	A		FKM
64	80	8		18009	W	A		NBR
64	80	13		61402	W	A	S	NBR
64	85	10		18012	W	A		NBR
64	85	10		40403	W	C		NBR
64	85	12		44323	W	A		NBR
64	85	12		39826	W	A	S	NBR

Any seal. Any time.

www.dichtomatik.de



d1	d2	H	H2	产品编码	产品组	设计型号	形式	材质
64	85	13		18013	W	A		NBR
64	85	13		38488	W	C		NBR
64	85	13		63333	W	A		FKM
64	85	16		18014	W	A	S	NBR
64	85	16		63334	W	A	S	FKM
64	86	10		41017	W	A	S	NBR
64	88	6		163117	W	A	S	NBR
64	90	10		40405	W	C		NBR
64	90	13		61731	W	C	S	NBR
64	90	13		18015	W	A	S	NBR
64	90	13		25969	W	B	S	NBR
64	90	13		38715	W	C		NBR
64	90	13		63349	W	A	S	FKM
64	92	13		42551	W	B	S	NBR
64	100	10		25726	W	C		NBR
64	100	13		25727	W	C		NBR
64.5	89.2	13		40239	W	B	S	NBR
65	75	5		49323	W	A	OK	NBR
65	75	8		40404	W	C		NBR
65	75	8		48032	W	A	S	NBR
65	77	4		42552	W	B	O	NBR
65	78	12		40240	W	B	S	NBR
65	80	7		157305	W	A	SY	NBR
65	80	7		157262	W	A	SY	FKM
65	80	8		56826	W	A	S	FKM
65	80	8		18016	W	A		NBR
65	80	8		18017	W	B		NBR
65	80	8		173008	W	A		NBR
65	80	8		180980	W	A	S	NBR
65	80	8		20408	W	A		FKM
65	80	8		38691	W	B	S	NBR
65	80	8		39827	W	A	S	NBR
65	80	10		18019	W	B		NBR
65	80	10		20676	W	A	S	NBR
65	80	10		18020	W	C		NBR
65	80	10		18018	W	A		NBR
65	80	10		22528	W	A	S	FKM
65	80	10		163015	W	C		NBR
65	80	10		20409	W	A		FKM
65	80	12		63317	W	A		FKM
65	80	12		18023	W	C		NBR
65	80	12		19418	W	A	S	NBR
65	80	12		18021	W	A		NBR
65	80	12		18022	W	B		NBR
65	80	13		18024	W	C		NBR
65	80	13		44252	W	A		NBR
65	82	9		39896	W	A	S	NBR
65	82	10		144061	W	A		NBR
65	82	12		41023	W	A		NBR
65	83	10		41024	W	A	S	NBR
65	83	10		42553	W	B	S	NBR
65	84	9		39899	W	A	S	NBR
65	85	5		42554	W	B	O	NBR
65	85	8		56827	W	A		FKM
65	85	8		40241	W	B		NBR



油封

尺寸



油封

尺寸



d1	d2	H	H2	产品编码	产品组	设计型号	形式	材质
65	85	8		19419	W	A		NBR
65	85	8		157306	W	A	SY	NBR
65	85	8		48658	W	A	SY	FKM
65	85	8		39900	W	A	S	NBR
65	85	9		41026	W	A		NBR
65	85	10		18028	W	C		NBR
65	85	10		18025	W	A		NBR
65	85	10		18026	W	A	S	NBR
65	85	10		40242	W	B	S	NBR
65	85	10		18027	W	B		NBR
65	85	10		60348	W	C		FKM
65	85	10		118324	W	A	SY	NBR
65	85	10		20410	W	A		FKM
65	85	10		36446	W	A	S	FKM
65	85	10		130746	W	A		FKM
65	85	10		131060	W	A	S	FKM
65	85	12		49583	W	C		FKM
65	85	12		62543	W	A		FKM
65	85	12		18031	W	C		NBR
65	85	12		19420	W	A	S	NBR
65	85	12		40243	W	B	S	NBR
65	85	12		18029	W	A		NBR
65	85	12		18030	W	B		NBR
65	85	13		22529	W	A	S	FKM
65	85	13		79619	W	A		FKM
65	85	13		18032	W	A	S	NBR
65	85	13		26434	W	A		NBR
65	85	13		18033	W	B		NBR
65	85	13		19679	W	C		NBR
65	86	9.52		39901	W	A		NBR
65	88	5		40790	W	A	O	NBR
65	88	6		60349	W	B	O	NBR
65	88	12		35107	W	A		NBR
65	88	12		40791	W	A	O	NBR
65	88	12		19421	W	A	S	NBR
65	88	12		40244	W	B	S	NBR
65	89	13		39902	W	A	S	NBR
65	90	7		133595	W	A	SY	FKM
65	90	7		48534	W	A	SY	NBR
65	90	8		41027	W	A	S	NBR
65	90	10		48538	W	A	SY	NBR
65	90	10		19422	W	A	S	NBR
65	90	10		18034	W	A		NBR
65	90	10		18035	W	B		NBR
65	90	10		18036	W	C		NBR
65	90	10		19743	W	B	S	NBR
65	90	10		130849	W	A		FKM
65	90	10		22530	W	A	S	FKM
65	90	10		157263	W	A	SY	FKM
65	90	10		169617	W	B		NBR
65	90	10		20411	W	A		FKM
65	90	12		18037	W	A		NBR
65	90	12		18039	W	C		NBR
65	90	12		41411	W	C	S	NBR
65	90	12		19423	W	A	S	NBR

Any seal. Any time.

www.dichtomatik.de



d1	d2	H	H2	产品编码	产品组	设计型号	形式	材质
65	90	12		18038	W	B		NBR
65	90	12		62544	W	A		FKM
65	90	13		18040	W	A		NBR
65	90	13		18647	W	B	S	NBR
65	90	13		133603	W	A	SY	NBR
65	90	13		63350	W	A		FKM
65	90	13		18041	W	B		NBR
65	90	13		18042	W	C		NBR
65	90	13		19424	W	A	S	NBR
65	90	15		40245	W	B	S	NBR
65	90	15		41028	W	A	S	NBR
65	92	12		44228	W	A		NBR
65	92	13		18043	W	A		NBR
65	92	13		63351	W	A		FKM
65	95	10		18044	W	A		NBR
65	95	10		18045	W	B		NBR
65	95	10		20458	W	A		FKM
65	95	10		39903	W	A	S	NBR
65	95	10		18046	W	C		NBR
65	95	12		39905	W	A	S	NBR
65	95	13		19425	W	A	S	NBR
65	95	13		18048	W	C		NBR
65	95	13		63353	W	A		FKM
65	95	13		18047	W	A		NBR
65	95	14		19426	W	A	S	NBR
65	95	16		18049	W	A		NBR
65	98	15		41029	W	A	S	NBR
65	100	10		19427	W	A	S	NBR
65	100	10		20750	W	A		FKM
65	100	10		18050	W	A		NBR
65	100	10		18051	W	B		NBR
65	100	10		18052	W	C		NBR
65	100	10		62545	W	A	S	FKM
65	100	12		63451	W	A		FKM
65	100	12		156945	W	A	S	FKM
65	100	12		18054	W	C		NBR
65	100	12		19428	W	A	S	NBR
65	100	12		18053	W	A		NBR
65	100	12		169666	W	A	S	FKM
65	100	13		18055	W	A		NBR
65	100	13		22179	W	A	S	NBR
65	100	13		44406	W	C	S	NBR
65	100	13		63452	W	A		FKM
65	100	13		18056	W	C		NBR
65	100	13		18646	W	B	S	NBR
65	110	10		39906	W	A	S	NBR
65	110	10		63465	W	A		FKM
65	110	10		18057	W	A		NBR
65	110	12		80858	W	A	S	NBR
65	110	13		41030	W	A		NBR
65	115	15		26416	W	A		NBR
65	120	10		117913	W	A		NBR
65	120	12		19429	W	A		NBR
65	120	12		179262	W	A	S	NBR
65	120	12		179930	W	A	S	FKM



油封

尺寸



油封

尺寸



d1	d2	H	H2	产品编码	产品组	设计型号	形式	材质
65	120	13		34921	W	A	S	NBR
65	125	12		18058	W	A		NBR
65	125	12		63491	W	A		FKM
65	125	12		162320	W	A	S	FKM
65	140	10		41025	W	A	S	NBR
65.08	85.72	9.52		20819	W	A		NBR
65.08	88.9	12.7		48376	W	A	S	NBR
65.08	91.89	12.7		60903	W	C	S	NBR
65.08	92.07	12.7		59720	W	A		NBR
65.88	88.9	12.7		63342	W	A		FKM
66	80	17		41020	W	A	S	NBR
66	86	9.52		39898	W	A		NBR
66	90	10		59437	W	C		NBR
66	90	13		40406	W	C		NBR
66	100	11		19430	W	A		NBR
66.04	95.38	12.7		158086	W	B	S	NBR
66.06	80.5	11		125749	W	B		NBR
66.5	85	10		41021	W	A	S	NBR
66.6	85	12.7		49471	W	A		NBR
66.6	91.95	13		49472	W	A		NBR
66.67	85.72	7.93		20161	W	A		NBR
66.67	85.72	9.52		59923	W	A	S	NBR
66.67	85.72	9.52		56828	W	A		FKM
66.67	85.72	9.52		60904	W	C	S	NBR
66.67	85.72	9.52		19967	W	A		NBR
66.67	85.83	9.52		59924	W	A	S	NBR
66.67	88.9	12.7		59925	W	A	S	NBR
66.67	88.9	12.7		60583	W	B		NBR
66.67	88.9	12.7		19968	W	A		NBR
66.67	89.3	10		163118	W	A	S	NBR
66.67	92.07	11.91		56829	W	A		FKM
66.67	92.07	12.7		20162	W	A		NBR
66.67	92.07	12.7		59926	W	A	S	NBR
66.67	95.25	12.7		19970	W	A		NBR
66.67	95.25	12.7		59927	W	A	S	NBR
66.67	95.25	15.87		59928	W	A	S	NBR
66.67	101.6	12.7		20823	W	A		NBR
66.67	101.6	12.7		59929	W	A	S	NBR
67	80	6.7		41031	W	A		NBR
67	80	13		40407	W	C		NBR
67	82.5	11		41022	W	A	S	NBR
67	85	10		37736	W	C		NBR
67	85	10		179873	W	A	S	NBR
67	87	8		179431	W	A	S	NBR
67	89	13		40246	W	B	S	NBR
68	72	7		39907	W	A	S	NBR
68	79.3	7		41032	W	A		NBR
68	80	7		130572	W	A	S	FKM
68	80	8		42102	W	B		NBR
68	80	8		39908	W	A	S	NBR
68	80	10		57695	W	A	S	NBR
68	80	10		57696	W	B		NBR
68	82	7		39909	W	A	S	NBR
68	82	10		36572	W	A		NBR
68	82	10		81931	W	A	S	NBR

Any seal. Any time.

www.dichtomatik.de



d1	d2	H	H2	产品编码	产品组	设计型号	形式	材质
68	82	12		41033	W	A	S	NBR
68	83	10		19431	W	A	S	NBR
68	85	8		24367	W	A		NBR
68	85	8		81277	W	B	S	NBR
68	85	10		38303	W	A		NBR
68	85	10		17374	W	B		NBR
68	85	10		39910	W	A	S	NBR
68	85	13		19432	W	A	S	NBR
68	85	13		44512	W	A		NBR
68	86	10		19433	W	A	S	NBR
68	87	8		18059	W	A	S	NBR
68	88	9		39911	W	A	S	NBR
68	88	9.5		40247	W	B	S	NBR
68	88	10		40408	W	C	S	NBR
68	90	6		38370	W	A		FKM
68	90	6		38371	W	A	S	FKM
68	90	7		130942	W	A	S	NBR
68	90	10		18060	W	A		NBR
68	90	10		157264	W	A	SY	FKM
68	90	10		40248	W	B		NBR
68	90	10		40409	W	C	S	NBR
68	90	10		19758	W	C		NBR
68	90	10		20412	W	A		FKM
68	90	10		65402	W	B	S	NBR
68	90	10		157307	W	A	SY	NBR
68	90	10		19434	W	A	S	NBR
68	90	10		22531	W	A	S	FKM
68	90	10		163029	W	C		NBR
68	90	12		25976	W	C		NBR
68	90	12		19435	W	A	S	NBR
68	90	12		40249	W	B	S	NBR
68	90	12		44253	W	A		NBR
68	90	13		19436	W	B		NBR
68	90	13		24368	W	A		NBR
68	90	13		40410	W	C	S	NBR
68	90	13		39256	W	A	S	NBR
68	92	10		143295	W	A	S	NBR
68	92	12		18061	W	B	S	NBR
68	94	8		18062	W	A	S	NBR
68	95	10		19437	W	A		NBR
68	95	12		19438	W	A		NBR
68	95	13		18063	W	A		NBR
68	95	13		63354	W	A		FKM
68	95	13		39912	W	A	S	NBR
68	100	10		19439	W	A	S	NBR
68	100	10		20413	W	A		FKM
68	100	10		18064	W	A		NBR
68	100	12		38489	W	C		NBR
68	100	12		39913	W	A	S	NBR
68	100	13		18065	W	A		NBR
68	100	13		63453	W	A		FKM
68	110	13		39914	W	A	S	NBR
68	110	13		83471	W	C		NBR
68	110	13		38692	W	B	S	NBR
68.26	95.25	12.7		48741	W	C		NBR



油封

尺寸



油封

尺寸



d1	d2	H	H2	产品编码	产品组	设计型号	形式	材质
68.26	95.25	12.7		60584	W	B		NBR
68.26	95.25	12.7		59930	W	A	S	NBR
68.26	95.25	12.7		59721	W	A		NBR
68.26	95.25	12.7		173158	W	A	SY	FKM
68.26	98.42	12.7		35368	W	A		NBR
68.26	101.6	12.7		20163	W	A		NBR
68.3	80	4.8		165702	W	B	O	NBR
69	85	10		74240	W	B	S	NBR
69	85	12		40250	W	B	S	NBR
69	88	10		42555	W	C	S	NBR
69	90	10		161671	W	A		NBR
69	90	10		39915	W	A		NBR
69.85	85.72	12.7		20164	W	A		NBR
69.85	86.09	7.93		26195	W	A		NBR
69.85	86.09	7.93		59931	W	A	S	NBR
69.85	88.9	9.52		27022	W	A	S	NBR
69.85	88.9	9.52		19969	W	A		NBR
69.85	88.9	9.52		56830	W	A		FKM
69.85	88.9	12.7		20847	W	A	S	NBR
69.85	88.9	12.7		60586	W	B		NBR
69.85	88.9	12.7		134355	W	A	S	FKM
69.85	88.9	12.7		173159	W	A	SY	FKM
69.85	89.99	11.11		60905	W	C	S	NBR
69.85	92.07	12.7		20165	W	A		NBR
69.85	95.25	9.52		59932	W	A	S	NBR
69.85	95.25	11.11		60867	W	C		NBR
69.85	95.25	11.11		60728	W	B	S	NBR
69.85	95.25	12.7		59933	W	A	S	NBR
69.85	95.25	12.7		40411	W	C		NBR
69.85	95.25	12.7		19971	W	A		NBR
69.85	95.25	12.7		60587	W	B		NBR
69.85	95.25	12.7		60906	W	C	S	NBR
69.85	95.25	15.87		49464	W	B	S	NBR
69.85	95.65	11.11		60868	W	C		NBR
69.85	98.42	11.11		60869	W	C		NBR
69.85	98.42	11.91		20234	W	B		NBR
69.85	98.42	12.7		59934	W	A	S	NBR
69.85	98.42	12.7		20166	W	A		NBR
69.85	101.6	11.11		60907	W	C	S	NBR
69.85	101.6	12.7		60588	W	B		NBR
69.85	101.6	12.7		20167	W	A		NBR
69.85	101.6	12.7		59935	W	A	S	NBR
69.85	104.78	11.11		60589	W	B		NBR
69.85	107.95	11.11		60908	W	C	S	NBR
69.85	107.95	12.7		59936	W	A	S	NBR
#								
69.85	114.3	12.7		20826	W	A		NBR
70	78	5		22097	W	A	OK	NBR
70	80	5		68270	W	A	OK	NBR
70	80	6		41034	W	A		NBR
70	80	10		39916	W	A	S	NBR
70	81.5	6		81349	W	A	OK	NBR
70	81.5	6.5		36962	W	A		NBR
70	82	7		42558	W	B	O	NBR
70	83	5		44370	W	A		NBR
70	83.5	3		41035	W	A	O	NBR

Any seal. Any time.

www.dichtomatik.de



d1	d2	H	H2	产品编码	产品组	设计型号	形式	材质
70	84	8		19440	W	A	S	NBR
70	85	6		83613	W	A		NBR
70	85	7		83179	W	A		FKM
70	85	7		19441	W	A		NBR
70	85	8		18068	W	B		NBR
70	85	8		20414	W	A		FKM
70	85	8		18066	W	A		NBR
70	85	8		18067	W	A	S	NBR
70	85	8		24346	W	B	S	NBR
70	85	8		63335	W	A	S	FKM
70	85	8.5		42557	W	B	O	NBR
70	85	9		39921	W	A	S	NBR
70	85	10		39922	W	A	S	NBR
70	85	10		18069	W	A		NBR
70	85	10		18070	W	B		NBR
70	85	10		18071	W	C		NBR
70	85	10		63336	W	A		FKM
70	85.6	5.3		41036	W	A	O	NBR
70	86	8.5		41037	W	A		NBR
70	86	10		42556	W	B	S	NBR
70	87	10		39923	W	A	S	NBR
70	88	9		56831	W	A		FKM
70	88	12		19442	W	A	S	NBR
70	88	12		40251	W	B	S	NBR
70	89	12		41038	W	A	S	NBR
70	90	7		39924	W	A	S	NBR
70	90	7		24354	W	A	SY	NBR
70	90	7		41039	W	A		NBR
70	90	7		115717	W	A	SY	FKM
70	90	10		22532	W	A	S	FKM
70	90	10		18074	W	B		NBR
70	90	10		18075	W	B	S	NBR
70	90	10		130986	W	A	S	FKM
70	90	10		134889	W	A	SY	FKM
70	90	10		130808	W	A		FKM
70	90	10		18072	W	A		NBR
70	90	10		18073	W	A	S	NBR
70	90	10		18076	W	C		NBR
70	90	10		36573	W	C	S	NBR
70	90	10		20415	W	A		FKM
70	90	10		157308	W	A	SY	NBR
70	90	12		25646	W	A	S	NBR
70	90	12		18077	W	A		NBR
70	90	12		18078	W	B		NBR
70	90	12		56833	W	A		FKM
70	90	12		84926	W	A	S	FKM
70	90	12		18079	W	C		NBR
70	90	12		18080	W	C	S	NBR
70	90	13		39925	W	A	S	NBR
70	90	13		83196	W	A	S	FKM
70	90	13		19443	W	A		NBR
70	90	13		20472	W	A		FKM
70	90	13		18081	W	B		NBR
70	90	13		18082	W	C		NBR
70	90	13		117518	W	B	S	FKM



油封

尺寸



油封

尺寸



d1	d2	H	H2	产品编码	产品组	设计型号	形式	材质
70	92	5		41060	W	A	O	NBR
70	92	7		41058	W	A	S	NBR
70	92	9		39926	W	A	S	NBR
70	92	10		21115	W	B		NBR
70	92	12		19444	W	A		NBR
70	92	12		178838	W	A		FKM
70	92	12		19445	W	A	S	NBR
70	92	13		18083	W	A		NBR
70	92	13		39927	W	A	S	NBR
70	92	13		63352	W	A		FKM
70	92	14		41059	W	A		NBR
70	92	14		39051	W	B	S	NBR
70	93	12		41061	W	A	S	NBR
70	95	5		40789	W	A	O	NBR
70	95	10		39928	W	A	S	NBR
70	95	10		20417	W	C		FKM
70	95	10		18084	W	C		NBR
70	95	10		20473	W	A		FKM
70	95	10		62546	W	A	S	FKM
70	95	10		19446	W	A		NBR
70	95	12		39929	W	A	S	NBR
70	95	12		19447	W	A		NBR
70	95	13		19448	W	A	S	NBR
70	95	13		20418	W	A		FKM
70	95	13		18085	W	A		NBR
70	95	13		38616	W	C	S	NBR
70	95	13		18086	W	C		NBR
70	95	13		18648	W	B	S	NBR
70	95	13		130002	W	A	SY	NBR
70	95	13		18488	W	B		NBR
70	95	14		39930	W	A	S	NBR
70	96	13		41062	W	A		NBR
70	98	13		40447	W	C		NBR
70	98.5	13		39931	W	A	S	NBR
70	100	6		41201	W	A		NBR
70	100	8		18087	W	A	S	NBR
70	100	8		22533	W	A	S	FKM
70	100	8		60655	W	A		NBR
70	100	10		81507	W	B		NBR
70	100	10		22534	W	A	S	FKM
70	100	10		157265	W	A	SY	FKM
70	100	10		130848	W	A		FKM
70	100	10		157309	W	A	SY	NBR
70	100	10		19449	W	A	S	NBR
70	100	10		20419	W	A		FKM
70	100	10		18088	W	A		NBR
70	100	10		18089	W	B		NBR
70	100	10		18090	W	C		NBR
70	100	12		18091	W	A		NBR
70	100	12		39932	W	A	S	NBR
70	100	12		180210	W	A	S	FKM
70	100	12		20420	W	A		FKM
70	100	12		18092	W	B	S	NBR
70	100	12		18093	W	C		NBR
70	100	12		68897	W	B		NBR

Any seal. Any time.

www.dichtomatik.de



d1	d2	H	H2	产品编码	产品组	设计型号	形式	材质
70	100	13		19450	W	B		NBR
70	100	13		22597	W	A		FKM
70	100	13		18094	W	A		NBR
70	100	13		18095	W	C		NBR
70	100	13		39933	W	A	S	NBR
70	100	14		41065	W	A	S	NBR
70	100	15		41063	W	A	S	NBR
70	100	16		41064	W	A		NBR
70	105	12		144062	W	A	S	NBR
70	105	13		39934	W	A	S	NBR
70	105	13		18097	W	C		NBR
70	105	13		63459	W	A		FKM
70	105	13		18096	W	A		NBR
70	105	15		41066	W	A	S	NBR
70	110	8		39935	W	A	S	NBR
70	110	8		19451	W	A		NBR
70	110	10		18098	W	B		NBR
70	110	10		56834	W	A		FKM
70	110	10		65687	W	A		NBR
70	110	10		39936	W	A	S	NBR
70	110	10		166710	W	A	S	FKM
70	110	12		22838	W	B		NBR
70	110	12		63466	W	A		FKM
70	110	12		83449	W	A	S	NBR
70	110	12		18099	W	A		NBR
70	110	12		130752	W	A		FKM
70	110	13		18101	W	C		NBR
70	110	13		19452	W	A		NBR
70	110	13		18100	W	B		NBR
70	110	13		63474	W	A		FKM
70	110	13		39938	W	A	S	NBR
70	110	15		39937	W	A		NBR
70	111	13		18102	W	A		NBR
70	112	12		18103	W	A		NBR
70	112	12		63475	W	A		FKM
70	115	13		39939	W	A	S	NBR
70	115	15		19453	W	A		NBR
70	115	15		19454	W	A	S	NBR
70	120	12		83426	W	A		NBR
70	120	13		63481	W	A		FKM
70	120	13		48742	W	C		NBR
70	120	13		18104	W	A		NBR
70	120	13		38672	W	B		NBR
70	125	12		134947	W	A		FKM
70	125	12		39940	W	A	S	NBR
70	125	12		35079	W	A		NBR
70	125	12		134959	W	A	S	FKM
70	135	12		63508	W	A		FKM
70	135	12		18105	W	A		NBR
70	150	12		48694	W	A		NBR
71	83	12		41067	W	A		NBR
71	86	5		42559	W	B	O	NBR
71	88	8		39941	W	A	S	NBR
71	88	8		38754	W	A		NBR
71.43	88.9	9.52		59937	W	A	S	NBR



油封

尺寸



油封

尺寸



d1	d2	H	H2	产品编码	产品组	设计型号	形式	材质
71.43	92.07	9.52		37195	W	A	S	NBR
71.43	92.07	9.52		27563	W	A		NBR
71.43	95.25	11.11		60870	W	C		NBR
71.43	98.42	4.75		163726	W	B	O	NBR
71.65	89	9.52		60590	W	B		NBR
71.81	86.05	7		73972	W	A	S	NBR
72	84	7		38693	W	B	S	NBR
72	84	7		18489	W	B		NBR
72	84	18		161997	W	B	S	NBR
72	85	8		18106	W	A		NBR
72	85	8		63337	W	A		FKM
72	85	8		162100	W	A		NBR
72	85	10		22598	W	A		FKM
72	85	10		20677	W	A		NBR
72	85.6	18		40252	W	B		NBR
72	86	7		61800	W	A	S	NBR
72	88	8		19455	W	A	S	NBR
72	90	8		19456	W	A		NBR
72	90	8		176061	W	A		FKM
72	90	10		19872	W	C	S	NBR
72	90	10		40446	W	C		NBR
72	90	10		83180	W	A		FKM
72	90	10		149437	W	B	S	FKM
72	90	10		17055	W	B	S	NBR
72	90	10		38755	W	A		NBR
72	90	10		38673	W	B		NBR
72	90	10		73959	W	A	S	NBR
72	90	13		18107	W	C		NBR
72	92	12		41068	W	A	S	NBR
72	94	12		19457	W	A	S	NBR
72	95	10		19458	W	A		NBR
72	95	10		116032	W	A	SY	NBR
72	95	10		20474	W	A		FKM
72	95	10		64608	W	C		FKM
72	95	10		40254	W	B		NBR
72	95	10		56726	W	C		NBR
72	95	12		60329	W	C		NBR
72	95	12		24364	W	A		NBR
72	95	12		69688	W	A		FKM
72	95	13		18649	W	B	S	NBR
72	95	13		38490	W	C		NBR
72	95	13		18108	W	A		NBR
72	95	13		63355	W	A		FKM
72	96	9		39942	W	A	S	NBR
72	100	10		35704	W	A	S	NBR
72	100	10		36924	W	C		NBR
72	100	10		62547	W	A		FKM
72	100	10		62548	W	A	S	FKM
72	100	10		130758	W	A		FKM
72	100	10		40253	W	B		NBR
72	100	10		18109	W	A		NBR
72	100	12		25648	W	A	S	NBR
72	100	13		41069	W	A	S	NBR
72	100	13		27626	W	C		FKM
72	100	13		18110	W	A		NBR

Any seal. Any time.

www.dichtomatik.de



d1	d2	H	H2	产品编码	产品组	设计型号	形式	材质
72	100	13		63454	W	A		FKM
72	105	10		19459	W	A	S	NBR
72	105	13		40255	W	B	S	NBR
72	105	13		39943	W	A	S	NBR
72	110	12		38444	W	A		NBR
72	110	13		40445	W	C		NBR
72	110	13		175802	W	A	S	FKM
72	110	13		127466	W	A	S	NBR
72.24	101.8	12.7		40444	W	C		NBR
72.62	92.32	12.7		163168	W	A		NBR
73	90	8		40139	W	B	S	NBR
73	95	10		39944	W	A		NBR
73	95	10		40443	W	C		NBR
73	96	9		39945	W	A	S	NBR
73	100	13		20426	W	A		FKM
73	100	13		40442	W	C		NBR
73.02	92.07	7.93		20169	W	A		NBR
73.02	92.07	9.52		60591	W	B		NBR
73.02	92.07	9.52		59938	W	A	S	NBR
73.02	92.07	9.52		20170	W	A		NBR
73.02	92.07	9.52		60729	W	B	S	NBR
73.02	95.25	11.11		60909	W	C	S	NBR
73.02	95.25	12.7		20171	W	A		NBR
73.02	95.25	12.7		59939	W	A	S	NBR
73.02	98.42	11.11		83472	W	C		NBR
73.02	98.42	12.7		59940	W	A	S	NBR
73.02	98.42	12.7		20822	W	A		NBR
73.02	98.43	11.11		74041	W	C		NBR
73.02	98.58	9.52		37876	W	B	S	NBR
73.02	101.6	9.52		41526	W	C		NBR
73.02	101.6	12.7		59941	W	A	S	NBR
73.02	101.6	12.7		60593	W	B		NBR
73.02	101.6	12.7		20172	W	A		NBR
73.02	101.6	12.7		42560	W	C		NBR
73.02	101.6	16.27		122452	W	B		NBR
73.02	104.85	14.68		60594	W	B		NBR
73.02	107.95	12.7		20173	W	A		NBR
73.02	114.3	11.11		60871	W	C		NBR
73.5	110	10		35104	W	A		NBR
73.5	110	13		165742	W	A	S	NBR
74	88	10		73092	W	A		NBR
74	90	10		18111	W	B	S	NBR
74	90	10		26538	W	B		NBR
74	93	12		39946	W	A	S	NBR
74	95	7		39020	W	A	O	NBR
74	95	10		41070	W	A	S	NBR
74	95	10		40441	W	C		NBR
74	95	13		40140	W	B		NBR
74	96	9		39947	W	A	S	NBR
74	98	12		39948	W	A	S	NBR
74	100	13		40440	W	C		NBR
74	100	13		19460	W	B		NBR
74	101.4	12		19825	W	A		NBR
74	101.4	12		63458	W	A		FKM
74	105	12		63460	W	A		FKM



油封

尺寸



油封

尺寸



d1	d2	H	H2	产品编码	产品组	设计型号	形式	材质
74	105	12		18112	W	A		NBR
74	135	15		57182	W	A		NBR
74.3	100.01	12.7		60595	W	B		NBR
74.61	88.9	7.93		41071	W	A	O	NBR
74.61	95.25	9.52		36272	W	A		NBR
74.61	95.25	9.52		60731	W	B	S	NBR
74.61	101.6	12.7		60730	W	B	S	NBR
74.61	101.6	15.87		24104	W	C	S	NBR
74.61	101.6	16.27		38372	W	C	S	NBR
74.61	101.6	16.27		38373	W	C		NBR
74.61	101.6	16.91		42562	W	B	S	NBR
74.61	104.77	9.52		60872	W	C		NBR
74.61	104.77	9.52		60910	W	C	S	NBR
75	85	6		163169	W	A	S	NBR
75	85	13		116427	W	A		FKM
75	90	5		42563	W	B	O	NBR
75	90	6		41072	W	A	S	NBR
75	90	6		44594	W	A	OK	NBR
75	90	7		41073	W	A	S	NBR
75	90	7		18113	W	B		NBR
75	90	8		27537	W	A	S	NBR
75	90	8		83197	W	A	S	FKM
75	90	8		20421	W	A		FKM
75	90	8		18114	W	A		NBR
75	90	10		18115	W	A		NBR
75	90	10		26174	W	A	S	NBR
75	90	10		20422	W	A		FKM
75	90	10		18116	W	C		NBR
75	90	10		157266	W	A	SY	FKM
75	90	10		48988	W	A	SY	NBR
75	90	12		18117	W	C		NBR
75	90	12		48802	W	A		NBR
75	90	13		40141	W	B	S	NBR
75	91.5	6		41074	W	A		NBR
75	92	7		41075	W	A		NBR
75	92	12		39949	W	A	S	NBR
75	95	5		25823	W	B		NBR
75	95	7		133596	W	A	SY	FKM
75	95	7		39950	W	A	S	NBR
75	95	7		118702	W	A	SY	NBR
75	95	8		25653	W	A	S	NBR
75	95	8		159422	W	A	S	NBR
75	95	8		69275	W	A		NBR
75	95	9		38470	W	A	S	NBR
75	95	9		49305	W	A	S	FKM
75	95	10		18120	W	C		NBR
75	95	10		144219	W	A	SY	FKM
75	95	10		39951	W	A	S	NBR
75	95	10		18119	W	B		NBR
75	95	10		177170	W	A		NBR
75	95	10		177171	W	A		FKM
75	95	10		20423	W	A		FKM
75	95	10		18118	W	A		NBR
75	95	10		81720	W	A	SY	NBR
75	95	10		25971	W	B	S	NBR

Any seal. Any time.
www.dichtomatik.de



d1	d2	H	H2	产品编码	产品组	设计型号	形式	材质
75	95	10		22535	W	A	S	FKM
75	95	10		158099	W	A		NBR
75	95	12		79361	W	B	S	NBR
75	95	12		18123	W	C		NBR
75	95	12		20424	W	A		FKM
75	95	12		18121	W	A		NBR
75	95	12		18122	W	B		NBR
75	95	12		19461	W	A	S	NBR
75	95	13		20950	W	C		NBR
75	95	13		60331	W	B		NBR
75	95	13		39181	W	A	S	NBR
75	95	13		19462	W	A		NBR
75	95.5	11		41076	W	A		NBR
75	96	11		89351	W	B	S	NBR
75	98	12		41077	W	A	S	NBR
75	100	7		41078	W	A		NBR
75	100	8		117565	W	A	SY	NBR
75	100	8		42564	W	B	S	NBR
75	100	10		18128	W	C	S	NBR
75	100	10		131053	W	A	S	FKM
75	100	10		161602	W	A		NBR
75	100	10		18127	W	C		NBR
75	100	10		19463	W	B	S	NBR
75	100	10		72589	W	B		FKM
75	100	10		61258	W	C		FKM
75	100	10		18124	W	A		NBR
75	100	10		18125	W	A	S	NBR
75	100	10		20425	W	A		FKM
75	100	10		22536	W	A	S	FKM
75	100	10		18126	W	B		NBR
75	100	11		157218	W	A	SY	FKM
75	100	11		157279	W	A	SY	NBR
75	100	12		18130	W	B		NBR
75	100	12		41084	W	A	S	NBR
75	100	12		18131	W	C		NBR
75	100	12		56835	W	A		FKM
75	100	12		18129	W	A		NBR
75	100	12		59397	W	A	S	FKM
75	100	13		18132	W	A		NBR
75	100	13		60332	W	A		FKM
75	100	13		18134	W	C	S	NBR
75	100	13		19759	W	B		NBR
75	100	13		130003	W	A	SY	NBR
75	100	13		18133	W	C		NBR
75	100	13		19465	W	A	S	NBR
75	100	13		18650	W	B	S	NBR
75	100	14		41079	W	A	S	NBR
75	100	15		41080	W	A	S	NBR
75	101	12		19824	W	A		NBR
75	101	12		63457	W	A		FKM
75	101	13		41081	W	A	S	NBR
75	102	12		39952	W	A	S	NBR
75	102	12		39953	W	A		NBR
75	105	12		41082	W	A		NBR
75	105	12		48743	W	C	S	NBR



油封

尺寸



油封

尺寸



d1	d2	H	H2	产品编码	产品组	设计型号	形式	材质
75	105	12		18135	W	B	S	NBR
75	105	12		39954	W	A	S	NBR
75	105	12		74602	W	C		NBR
75	105	13		19466	W	A	S	NBR
75	105	13		39955	W	A		NBR
75	105	13		18490	W	B		NBR
75	105	13		18136	W	C		NBR
75	105	15		19467	W	A	S	NBR
75	105	15		41083	W	A		NBR
75	110	10		39956	W	A	S	NBR
75	110	10		35509	W	A		NBR
75	110	10		35510	W	B		NBR
75	110	12		38674	W	B		NBR
75	110	12		18137	W	A		NBR
75	110	12		39957	W	A	S	NBR
75	110	12		38694	W	B	S	NBR
75	110	12		22599	W	A		FKM
75	110	13		19468	W	A		NBR
75	110	13		39958	W	A	S	NBR
75	110	13		18139	W	C		NBR
75	110	13		40142	W	B	S	NBR
75	110	13		22600	W	A		FKM
75	110	13		18138	W	B		NBR
75	112	12		19827	W	A		NBR
75	112	12		63476	W	A		FKM
75	115	9.52		35523	W	A		NBR
75	115	10		26272	W	A		NBR
75	115	10		179928	W	A	S	NBR
75	115	12		48661	W	A	S	FKM
75	115	12		19469	W	A		NBR
75	115	13		17103	W	C		NBR
75	115	13		179756	W	A	S	NBR
75	115	13		92939	W	C	S	NBR
75	115	16		19828	W	A		NBR
75	120	10		44828	W	A		FKM
75	120	10		131001	W	A	S	NBR
75	120	12		63482	W	A		FKM
75	120	12		130834	W	A		FKM
75	120	12		117912	W	A	S	NBR
75	120	12		18140	W	A		NBR
75	120	13		42566	W	B	S	NBR
75	121	13		40143	W	B	S	NBR
75	122	12		19830	W	B		NBR
75	125	12		44381	W	A		NBR
75	130	10		150147	W	A	S	NBR
75	130	12		19470	W	A		NBR
75	130	13		35526	W	A		NBR
75	130	13		143474	W	A		FKM
75	135	13		19832	W	A		NBR
76	94	10		42567	W	B	S	NBR
76	98	12		39959	W	A	S	NBR
76	98.58	12		42570	W	C	S	NBR
76	100	12		39960	W	A	S	NBR
76	100	16		44560	W	A	S	NBR
76	101.8	12		42568	W	C	S	NBR

Any seal. Any time.

www.dichtomatik.de



d1	d2	H	H2	产品编码	产品组	设计型号	形式	材质
76	102	12		39961	W	A		NBR
76	105	12		19471	W	A	S	NBR
76	105	13		39962	W	A	S	NBR
76	105	13		63461	W	A		FKM
76	105	13		18141	W	A		NBR
76	120	12		19472	W	A		NBR
76.2	95.25	7.93		59722	W	A		NBR
76.2	95.25	9.52		22181	W	A		NBR
76.2	95.25	9.52		59942	W	A	S	NBR
76.2	95.25	12.7		19972	W	A		NBR
76.2	98.42	9.52		22182	W	A		NBR
76.2	98.43	11.11		59532	W	C		NBR
76.2	98.6	12		42571	W	C		NBR
76.2	101.6	9.52		59943	W	A	S	NBR
76.2	101.6	9.52		20174	W	A		NBR
76.2	101.6	9.52		60873	W	C		NBR
76.2	101.6	11		42569	W	B	S	NBR
76.2	101.6	11.11		60911	W	C	S	NBR
76.2	101.6	11.11		24663	W	C		NBR
76.2	101.6	12.7		59609	W	A	S	NBR
76.2	101.6	12.7		49463	W	B		NBR
76.2	101.6	12.7		40439	W	C		NBR
76.2	101.6	12.7		19973	W	A		NBR
76.2	101.68	9.52		158066	W	B	S	NBR
76.2	101.8	11.88		155758	W	C	S	NBR
76.2	104.78	14.28		42572	W	B	S	NBR
76.2	104.78	14.28		42573	W	C	S	NBR
76.2	107.95	12.7		83181	W	A		FKM
76.2	107.95	12.7		20175	W	A		NBR
76.2	107.95	12.7		59944	W	A	S	NBR
76.2	114.3	9.52		20176	W	A		NBR
76.2	114.3	11.11		60874	W	C		NBR
76.2	114.3	12.7		59945	W	A	S	NBR
76.2	114.3	12.7		19974	W	A		NBR
76.2	114.3	12.7		60596	W	B		NBR
76.2	114.3	15.87		20827	W	A		NBR
77	93	10		40144	W	B	S	NBR
77	95	10		38714	W	C		NBR
77	95	10		72773	W	A		NBR
77	95	10		130573	W	A	S	FKM
77	95	13		40438	W	C		NBR
77	100	10		18142	W	A		NBR
77	100	10		72922	W	C		NBR
77	100	10		63455	W	A		FKM
77.78	96.04	8.98		59723	W	A		NBR
77.78	104.77	12.7		37910	W	A		NBR
77.78	114.3	12.7		73236	W	A		FKM
78	90	8		49549	W	A		NBR
78	95	11		18143	W	A		NBR
78	95	11		166961	W	A		NBR
78	95	11		63356	W	A		FKM
78	95	13		20482	W	A		FKM
78	95	13		36443	W	C		NBR
78	98	12		41085	W	A	S	NBR
78	100	10		35534	W	C	S	NBR



油封

尺寸



油封

尺寸



d1	d2	H	H2	产品编码	产品组	设计型号	形式	材质
78	100	10		36900	W	A	S	NBR
78	100	10		18144	W	A		NBR
78	100	10		20427	W	A		FKM
78	100	10		40437	W	C		NBR
78	100	12		38713	W	C		NBR
78	100	12		41086	W	A	S	NBR
78	100	13		40678	W	A	S	NBR
78	100	13		44233	W	A		NBR
78	105	13		40436	W	C		NBR
78	105	13		26417	W	A		NBR
78	105	13		83182	W	A		FKM
78	105	15		26418	W	A		NBR
78	110	12		39963	W	A	S	NBR
78	110	12		20433	W	A		FKM
78	110	12		38756	W	A		NBR
78	110	13		39964	W	A	S	NBR
78	110	13		44254	W	A		NBR
78	115	10		41087	W	A	S	NBR
78	150.5	13		19836	W	A		NBR
78	150.5	13		63530	W	A		FKM
79	95.3	11		163170	W	A		NBR
79.37	101.6	11.11		42575	W	C	S	NBR
79.37	101.6	12.7		19975	W	A		NBR
79.37	104.77	9.52		20177	W	A		NBR
79.37	104.77	12.7		20178	W	A		NBR
79.37	104.77	12.7		59946	W	A	S	NBR
79.37	104.77	14.28		42574	W	B	S	NBR
79.37	107.95	12.7		20179	W	A		NBR
79.37	114.3	12.7		20180	W	A		NBR
79.37	114.3	12.7		60912	W	C	S	NBR
79.37	114.3	15.87		72689	W	A		NBR
79.37	117.47	12.7		48745	W	C		NBR
79.37	120.65	12.7		43949	W	A		NBR
80	85	3		156488	W	B	O	NBR
80	90	5		92937	W	A	OK	NBR
80	90	5		48959	W	A	O	FKM
80	90	12		20653	W	A	O	NBR
80	95	4		121509	W	C	O	NBR
80	95	5		42579	W	B	O	NBR
80	95	5		41088	W	A	OK	NBR
80	95	8		20481	W	A		FKM
80	95	8		36770	W	A		NBR
80	95	8		75029	W	A	S	NBR
80	95	8		59603	W	B		NBR
80	95	10		39965	W	A		NBR
80	95	11		42581	W	B	S	NBR
80	100	7		42580	W	B	O	NBR
80	100	7		24355	W	A	SY	NBR
80	100	7		115718	W	A	SY	FKM
80	100	8		42578	W	B	O	NBR
80	100	9		40145	W	B		NBR
80	100	10		63571	W	C		FKM
80	100	10		79620	W	A		FKM
80	100	10		35355	W	A	S	FKM
80	100	10		18145	W	A		NBR

Any seal. Any time.

www.dichtomatik.de



d1	d2	H	H2	产品编码	产品组	设计型号	形式	材质
80	100	10		18149	W	C		NBR
80	100	10		131071	W	A	S	FKM
80	100	10		130750	W	A		FKM
80	100	10		134890	W	A	SY	FKM
80	100	10		42576	W	B	O	NBR
80	100	10		18146	W	A	S	NBR
80	100	10		18147	W	B		NBR
80	100	10		48746	W	C	S	NBR
80	100	10		20428	W	A		FKM
80	100	10		18148	W	B	S	NBR
80	100	12		19473	W	A		NBR
80	100	12		44458	W	B	S	NBR
80	100	12		62549	W	A		FKM
80	100	12		19474	W	A	S	NBR
80	100	12		55952	W	C		FKM
80	100	12		18150	W	B		NBR
80	100	12		18151	W	C		NBR
80	100	13		18152	W	A		NBR
80	100	13		38703	W	C	S	NBR
80	100	13		19475	W	A	S	NBR
80	100	13		18154	W	C		NBR
80	100	13		63456	W	A		FKM
80	100	13		19760	W	B	S	NBR
80	100	13		22537	W	A	S	FKM
80	100	13		18153	W	B		NBR
80	100	13		60335	W	B	S	FKM
80	100	14		26419	W	A		NBR
80	100	15		41089	W	A	S	NBR
80	100	18		41090	W	A	S	NBR
80	105	7		41092	W	A	OK	NBR
80	105	7.5		133597	W	A	SY	FKM
80	105	8.5		41091	W	A	S	NBR
80	105	10		18155	W	A		NBR
80	105	10		39966	W	A	S	NBR
80	105	10		63462	W	A		FKM
80	105	10		179929	W	A	S	FKM
80	105	10		60336	W	C		FKM
80	105	10		161480	W	A		NBR
80	105	12		40435	W	C		NBR
80	105	12		20505	W	A		FKM
80	105	12		77126	W	B	S	NBR
80	105	12		39967	W	A	S	NBR
80	105	12		27605	W	A		NBR
80	105	13		18158	W	C		NBR
80	105	13		19476	W	A	S	NBR
80	105	13		25972	W	B	S	NBR
80	105	13		18157	W	B		NBR
80	105	13		18156	W	A		NBR
80	105	13		63463	W	A		FKM
80	105	13		130004	W	A	SY	NBR
80	105	14		19477	W	A	S	NBR
80	105	15		76625	W	B		NBR
80	105	15		41093	W	A	S	NBR
80	106	8		42582	W	B	O	NBR
80	108	10		65445	W	C	S	NBR



油封

尺寸



油封

尺寸



d1	d2	H	H2	产品编码	产品组	设计型号	形式	材质
80	108	15		41094	W	A	S	NBR
80	110	10		22538	W	A	S	FKM
80	110	10		18160	W	A	S	NBR
80	110	10		18159	W	A		NBR
80	110	10		18161	W	B		NBR
80	110	10		18162	W	C		NBR
80	110	10		127332	W	A	SY	NBR
80	110	10		62550	W	A		FKM
80	110	10		42577	W	B	O	NBR
80	110	10		131073	W	A	S	FKM
80	110	12		18163	W	A		NBR
80	110	12		170422	W	A	S	FKM
80	110	12		40146	W	B	S	NBR
80	110	12		26935	W	A	S	NBR
80	110	12		20429	W	A		FKM
80	110	12		18164	W	B		NBR
80	110	12		18165	W	C		NBR
80	110	13		18169	W	C		NBR
80	110	13		39968	W	A	S	NBR
80	110	13		18166	W	A		NBR
80	110	13		104315	W	A		FKM
80	110	13		18167	W	B		NBR
80	110	13		18168	W	B	S	NBR
80	110	13		38740	W	C	S	NBR
80	110	14		38491	W	C		NBR
80	110	14		35575	W	A		NBR
80	110	15		39969	W	A	S	NBR
80	113	12		63477	W	A		FKM
80	113	12		18170	W	A		NBR
80	115	10		27984	W	A	S	NBR
80	115	10		19678	W	A		NBR
80	115	12		18171	W	A		NBR
80	115	12		56837	W	A		FKM
80	115	13		39970	W	A	S	NBR
80	115	15		19478	W	A	S	NBR
80	120	12		39973	W	A	S	NBR
80	120	12		144063	W	A		NBR
80	120	12		18172	W	C		NBR
80	120	13		18173	W	A		NBR
80	120	13		63483	W	A		FKM
80	120	13		39974	W	A	S	NBR
80	120	13		18174	W	B		NBR
80	120	13		18175	W	C		NBR
80	125	10		50973	W	A	S	NBR
80	125	12		18176	W	A		NBR
80	125	12		63492	W	A		FKM
80	125	13		41095	W	A	S	NBR
80	125	13		18177	W	B		NBR
80	125	13		18178	W	C		NBR
80	125	13		39975	W	A		NBR
80	125	14		39976	W	A	S	NBR
80	130	13		40147	W	B	S	NBR
80	130	13		18179	W	A		NBR
80	130	13		63501	W	A		FKM
80	130	13		146162	W	A	S	FKM

Any seal. Any time.

www.dichtomatik.de



d1	d2	H	H2	产品编码	产品组	设计型号	形式	材质
80	140	13		63515	W	A		FKM
80	140	13		34922	W	A	S	NBR
80	140	13		18180	W	A		NBR
80	145	13		63521	W	A		FKM
80	145	13		19835	W	A		NBR
80	150.5	13		19837	W	A		NBR
80.96	107.95	12.7		37196	W	A		NBR
80.96	111.12	12.7		35239	W	A		NBR
80.96	117.47	12.7		59947	W	A	S	NBR
80.96	120.65	12.7		83450	W	A	S	NBR
80.96	123.82	12.7		37454	W	A		NBR
81	88	3.8		41096	W	A	O	NBR
81.5	105	16		41097	W	A	S	NBR
82	100	8		176062	W	A		FKM
82	100	8		19479	W	A		NBR
82	105	12		18181	W	A		NBR
82	105	12		20430	W	A		FKM
82	105	12		39977	W	A	S	NBR
82	105	13		39978	W	A	S	NBR
82	105	13		38492	W	C		NBR
82	105	14		19480	W	A		NBR
82	110	12		18182	W	A		NBR
82	110	12		63467	W	A		FKM
82	110	13		18183	W	C		NBR
82	120	13		117723	W	A	S	NBR
82.5	105	10		41098	W	A	S	NBR
82.5	108	11		42804	W	C	S	NBR
82.5	108	12.7		40148	W	B		NBR
82.55	101.6	12.7		59948	W	A	S	NBR
82.55	101.6	12.7		19976	W	A		NBR
82.55	101.6	12.7		60597	W	B		NBR
82.55	101.6	12.7		163101	W	C		NBR
82.55	107.95	7.93		24437	W	A		NBR
82.55	107.95	9.52		37030	W	C	S	NBR
82.55	107.95	11.9		134607	W	C		NBR
82.55	107.95	12.7		60598	W	B		NBR
82.55	107.95	12.7		20181	W	A		NBR
82.55	107.95	12.7		178439	W	A		FKM
82.55	107.95	12.7		59949	W	A	S	NBR
82.55	107.95	15.87		48748	W	C		NBR
82.55	111.12	12.7		59950	W	A	S	NBR
82.55	114.3	11.5		42803	W	C	S	NBR
82.55	114.3	12.7		59951	W	A	S	NBR
82.55	114.3	12.7		20182	W	A		NBR
82.55	114.3	12.7		60599	W	B		NBR
82.55	114.3	15.87		59724	W	A		NBR
82.55	117.47	12.7		59952	W	A	S	NBR
82.55	120.15	9.52		37911	W	A		NBR
82.55	120.65	12.7		78292	W	B	S	NBR
82.55	120.65	12.7		24425	W	A		NBR
82.55	133.35	12.7		36273	W	C		NBR
83	110	12		18184	W	C		NBR
83	110	13		104316	W	A		FKM
83	110	13		89802	W	A		NBR
83	110	13		38200	W	C		NBR



油封

尺寸



油封

尺寸



d1	d2	H	H2	产品编码	产品组	设计型号	形式	材质
83.5	105	13		38493	W	C		NBR
84	105	12		41099	W	A	S	NBR
84	105	13		38495	W	C		NBR
84	110	12		55937	W	C		NBR
84	110	16		63468	W	A	S	FKM
84	110	16		19826	W	A	S	NBR
84.13	111.12	12.7		21010	W	A		NBR
84.13	114.3	11.91		60875	W	C		NBR
84.13	114.3	12.7		59953	W	A	S	NBR
85	100	6		41100	W	A	S	NBR
85	100	7		41101	W	A		NBR
85	100	9		127705	W	A		FKM
85	100	9		44466	W	A		NBR
85	100	9		18185	W	B		NBR
85	100	10		39979	W	A	S	NBR
85	100	10		39980	W	A		NBR
85	100	12		135225	W	A	S	FKM
85	100	12		39981	W	A	S	NBR
85	100	12		19481	W	A		NBR
85	100	12		18186	W	C		NBR
85	100	13		19482	W	A	S	NBR
85	100	13		153798	W	B		FKM
85	100	13		18187	W	C		NBR
85	102	9		41102	W	A	S	NBR
85	105	7.5		44100	W	A	SY	NBR
85	105	8		56417	W	A		NBR
85	105	9		41103	W	A	O	NBR
85	105	10		19483	W	A		NBR
85	105	10		18189	W	C		NBR
85	105	10		67964	W	A		FKM
85	105	10		18188	W	B		NBR
85	105	10		40149	W	B	S	NBR
85	105	10		38494	W	A	S	NBR
85	105	12		62551	W	A	S	FKM
85	105	12		104323	W	A		FKM
85	105	12		157267	W	A	SY	FKM
85	105	12		39982	W	A	S	NBR
85	105	12		51001	W	A	SY	NBR
85	105	12		27002	W	A		NBR
85	105	12		40150	W	B		NBR
85	105	13		167126	W	A		FKM
85	105	13		18191	W	B		NBR
85	105	13		18192	W	C		NBR
85	105	13		19485	W	A	S	NBR
85	105	13		40151	W	B	S	NBR
85	105	13		60338	W	A		FKM
85	105	13		18190	W	A		NBR
85	110	8		117566	W	A	SY	NBR
85	110	8		157219	W	A	SY	FKM
85	110	10		35787	W	A	S	NBR
85	110	10		69609	W	A		FKM
85	110	10		36054	W	A		NBR
85	110	12		38617	W	C	S	NBR
85	110	12		20431	W	A		FKM
85	110	12		18194	W	B		NBR

Any seal. Any time.

www.dichtomatik.de



d1	d2	H	H2	产品编码	产品组	设计型号	形式	材质
85	110	12		175908	W	A		NBR
85	110	12		22539	W	A	S	FKM
85	110	12		19487	W	B	S	NBR
85	110	12		130759	W	A		FKM
85	110	12		18193	W	A		NBR
85	110	12		131058	W	A	S	FKM
158.75	182.7	16		179844	W	A	Y	FKM
85	110	12		18195	W	C		NBR
85	110	12		19985	W	A	S	NBR
85	110	13		40152	W	B	S	NBR
85	110	13		18698	W	A		NBR
85	110	13		18197	W	C		NBR
85	110	13		18198	W	C	S	NBR
85	110	13		18493	W	B		NBR
85	110	13		18196	W	A	S	NBR
85	110	13		63470	W	A	S	FKM
85	110	13		63469	W	A		FKM
85	110	13		130005	W	A	SY	NBR
85	110	13		179145	W	A		NBR
85	110	14		35305	W	C		NBR
85	110	15		41104	W	A		NBR
85	110	15		38496	W	C		NBR
85	110	15		19488	W	A	S	NBR
85	111	10		39983	W	A	S	NBR
85	111	16		18199	W	B		NBR
85	115	13		18200	W	A		NBR
85	115	13		19676	W	C		NBR
85	115	13		36807	W	A	S	NBR
85	115	13		63478	W	A		FKM
85	115	15		19489	W	A		NBR
85	115	15		39984	W	A	S	NBR
85	115	16		41105	W	A	S	NBR
85	120	7.5		118703	W	A	SY	NBR
85	120	7.5		48662	W	A	SY	FKM
85	120	8		151686	W	A	SY	NBR
85	120	8		133598	W	A	SY	FKM
85	120	8		156279	W	A	S	NBR
85	120	10		74149	W	A	S	NBR
85	120	10		116534	W	A		NBR
85	120	12		38712	W	C		NBR
85	120	12		19490	W	A		NBR
85	120	12		23736	W	A		FKM
85	120	12		22540	W	A	S	FKM
85	120	12		26936	W	A	S	NBR
85	120	12		18201	W	B		NBR
85	120	13		18202	W	A		NBR
85	120	13		75065	W	B		NBR
85	120	13		19491	W	A	S	NBR
85	120	13		18203	W	C		NBR
85	120	13		42584	W	B	S	NBR
85	120	13		63484	W	A		FKM
85	120	13		63485	W	A	S	FKM
85	120	15		41107	W	A	S	NBR
85	120	15		59788	W	C		NBR
85	120	15		42802	W	B		NBR



油封

尺寸



油封

尺寸



d1	d2	H	H2	产品编码	产品组	设计型号	形式	材质
85	120	17		41106	W	A	S	NBR
85	124	12		39985	W	A	S	NBR
85	125	7		19492	W	A		NBR
85	125	12		63493	W	A		FKM
85	125	12		18204	W	A		NBR
85	125	13		18205	W	C		NBR
85	125	13		39986	W	A	S	NBR
85	125	14		19493	W	A	S	NBR
85	126	13		63496	W	A		FKM
85	126	13		18206	W	A		NBR
85	130	10		36886	W	A	S	NBR
85	130	10		117914	W	A		NBR
85	130	12		63502	W	A	S	FKM
85	130	12		171596	W	A	S	FKM
85	130	12		18207	W	A	S	NBR
85	130	12		20506	W	C		FKM
85	130	12		19494	W	A		NBR
85	130	12.7		35529	W	A		NBR
85	130	13		18209	W	C		NBR
85	130	13		60342	W	A	S	NBR
85	130	13		18208	W	B		NBR
85	130	13		22541	W	A	S	FKM
85	140	12		81106	W	A	S	NBR
85	140	12		83427	W	A		NBR
85	140	14		41108	W	A	S	NBR
85	150	10		171301	W	A	S	FKM
85	150	12		74633	W	A		NBR
85	150	12		39987	W	A	S	NBR
85	150	12		60343	W	B		FKM
85	150	13		35527	W	A		NBR
85	150	13		70516	W	B		NBR
85	155	12		19719	W	A		NBR
85	195	15		41109	W	A	S	NBR
85.72	101.6	12.7		35550	W	A		NBR
85.72	107.95	12.7		20183	W	A		NBR
85.72	111.12	9.52		59417	W	A	S	FKM
85.72	111.12	12.7		22219	W	A		NBR
85.72	111.12	15.87		60600	W	B		NBR
85.72	114.3	11.11		60876	W	C		NBR
85.72	114.3	12.7		19977	W	A		NBR
85.72	114.3	12.7		59954	W	A	S	NBR
85.72	114.3	15.87		60732	W	B	S	NBR
85.72	117.47	9.52		59955	W	A	S	NBR
85.72	117.47	11.11		60913	W	C	S	NBR
85.72	117.47	12.7		59956	W	A	S	NBR
85.72	117.47	12.7		37681	W	C		NBR
85.72	120.65	12.7		59957	W	A	S	NBR
85.72	127	11.91		44387	W	A		NBR
85.72	127	12.7		20831	W	A		NBR
86	100	7		83183	W	A		FKM
86	110	13		40155	W	B		NBR
86	110	13		69843	W	A		NBR
86	110	13		42805	W	B	O	NBR
86	110	13		42806	W	B	S	NBR
87	100	13		40432	W	C		NBR



d1	d2	H	H2	产品编码	产品组	设计型号	形式	材质
87	110	10		36062	W	C		NBR
87	110	10		35653	W	C	S	NBR
87	110	13		18210	W	A		NBR
87	110	13		63471	W	A		FKM
87	110	13		40431	W	C		NBR
87.31	114.3	12.7		20828	W	A		NBR
87.31	114.3	12.7		59958	W	A	S	NBR
87.5	111.12	12.7		42807	W	C		NBR
88	100	13		61425	W	A		NBR
88	105	12		83428	W	A		NBR
88	108	11		56012	W	A	S	NBR
88	110	12		18211	W	A		NBR
88	110	12		20432	W	A		FKM
88	110	13		63472	W	A		FKM
88	110	13		18212	W	A		NBR
88	110	13		25973	W	C		NBR
88	115	9		41110	W	A		NBR
88	115	9.5		40156	W	B	S	NBR
88	115	12		41111	W	A	S	NBR
88	120	10		64376	W	C		NBR
88	120	12		18213	W	A		NBR
88	120	12		63486	W	A		FKM
88	120	13		48750	W	C		NBR
88	120	13		78269	W	A	S	NBR
88	121.5	12		26420	W	A		NBR
88	126	12		18214	W	A		NBR
88	126	12		18215	W	B		NBR
88	126	12		63497	W	A		FKM
88	128	12		18216	W	A		NBR
88	128	12		63499	W	A		FKM
88	140	12		9493	W	A		NBR
88	140	13		18217	W	A		NBR
88	140	13		63516	W	A		FKM
88	140	13		179152	W	A	S	NBR
88	150.5	13		19838	W	A		NBR
88	150.5	15		19839	W	A		NBR
88.9	104.77	7.93		20824	W	A		NBR
88.9	104.77	9.52		59725	W	A		NBR
88.9	107.95	12.7		59959	W	A	S	NBR
88.9	107.95	12.7		59726	W	A		NBR
88.9	111.12	9.52		21876	W	A		NBR
88.9	111.12	9.52		41112	W	A	S	NBR
88.9	111.12	12.7		20825	W	A		NBR
88.9	111.12	12.7		59960	W	A	S	NBR
88.9	111.12	12.7		40430	W	C		NBR
88.9	111.12	15.87		60733	W	B	S	NBR
88.9	114.3	9.52		59961	W	A	S	NBR
88.9	114.3	9.52		20184	W	A		NBR
88.9	114.3	11.11		60914	W	C	S	NBR
88.9	114.3	11.9		48749	W	C		NBR
88.9	114.3	11.91		44386	W	A		NBR
88.9	114.3	12.7		60601	W	B		NBR
88.9	114.3	12.7		21957	W	A	S	NBR
88.9	114.3	12.7		19978	W	A		NBR
88.9	114.3	15.87		20829	W	A		NBR



油封

尺寸



油封

尺寸



d1	d2	H	H2	产品编码	产品组	设计型号	形式	材质
88.9	117.47	9.52		60877	W	C		NBR
88.9	117.47	12.7		60878	W	C		NBR
88.9	120.65	10		38497	W	C		NBR
88.9	120.65	12.7		20185	W	A		NBR
88.9	120.65	12.7		59962	W	A	S	NBR
88.9	120.65	14.28		81256	W	A	S	NBR
88.9	120.65	15.87		39235	W	B		NBR
88.9	120.7	10		69152	W	C		NBR
88.9	123.82	12.7		59727	W	A		NBR
88.9	127	12.7		20186	W	A		NBR
88.9	130.17	12.7		74387	W	A		NBR
88.9	136.52	12.7		20252	W	A		NBR
89	114	14		41113	W	A	S	NBR
89	115	13		19495	W	A	S	NBR
89	120	13		48751	W	C		NBR
89	120.8	6.5		42808	W	B	O	NBR
90	105	6		41117	W	A	OK	NBR
90	105	10		166087	W	A		NBR
90	105	13		144064	W	A	S	NBR
90	110	7		41118	W	A	OK	NBR
90	110	7.5		74399	W	A	SY	NBR
90	110	7.5		126562	W	A	S	NBR
90	110	7.5		48663	W	A	SY	FKM
90	110	8		18218	W	B		NBR
90	110	8		134262	W	C		FKM
90	110	8		19496	W	A		NBR
90	110	8		18219	W	C		NBR
90	110	10		18221	W	C		NBR
90	110	10		128177	W	A	SY	NBR
90	110	10		39989	W	A		NBR
90	110	10		75066	W	A		FKM
90	110	10		18220	W	B		NBR
90	110	10		39988	W	A	S	NBR
90	110	12		18222	W	A		NBR
90	110	12		18223	W	A	S	NBR
90	110	12		20434	W	A		FKM
90	110	12		157268	W	A	SY	FKM
90	110	12		36711	W	A		NBR
90	110	12		56838	W	A	S	FKM
90	110	12		169999	W	A		FKM
90	110	12		39217	W	A	SY	NBR
90	110	12		130751	W	A		FKM
90	110	12		18224	W	B		NBR
90	110	12		18225	W	C		NBR
90	110	12		131062	W	A	S	FKM
90	110	13		18227	W	B	S	NBR
90	110	13		18228	W	C		NBR
90	110	13		179124	W	A		FKM
90	110	13		18229	W	C	S	NBR
90	110	13		19497	W	A	S	NBR
90	110	13		22355	W	A		NBR
90	110	13		18226	W	B		NBR
90	110	13		56839	W	A	S	FKM
90	110	14		37625	W	A	S	NBR
90	110	15		22252	W	C		NBR

Any seal. Any time.

www.dichtomatik.de



d1	d2	H	H2	产品编码	产品组	设计型号	形式	材质
90	110	15		39990	W	A		NBR
90	110	15		27039	W	A	S	NBR
90	112	12		144065	W	A	S	NBR
90	112.7	13		19674	W	C		NBR
90	115	5		41119	W	A	O	NBR
90	115	8		39991	W	A		NBR
90	115	9		75030	W	A	S	NBR
90	115	9		37669	W	A		FKM
90	115	9		27457	W	A		NBR
90	115	9		18230	W	C		NBR
90	115	9		24197	W	B		NBR
90	115	10		39992	W	A	S	NBR
90	115	10		18231	W	A		NBR
90	115	12		41120	W	A	S	NBR
90	115	12		57135	W	A	S	FKM
90	115	12		44008	W	A		FKM
90	115	13		41122	W	A	O	NBR
90	115	13		130006	W	A	SY	NBR
90	115	13		38711	W	C		NBR
90	115	13		18233	W	B	S	NBR
90	115	13		63479	W	A		FKM
90	115	13		18232	W	A		NBR
90	115	13		19498	W	A	S	NBR
90	115	13		40157	W	B		NBR
90	115	13		42809	W	C	S	NBR
90	115	15		19499	W	A	S	NBR
90	117.5	12.5		73237	W	A	S	FKM
90	118	12		40158	W	B	S	NBR
90	118	12		40429	W	C	S	NBR
90	118	12		39993	W	A	S	NBR
90	118	15		41121	W	A	S	NBR
90	120	8		163172	W	B		NBR
90	120	8		41123	W	A	O	NBR
90	120	9		35176	W	A		FKM
90	120	10		72646	W	A		NBR
90	120	10		38675	W	B		NBR
90	120	10	10.5	157280	W	A	SY	NBR
90	120	12		37684	W	A		NBR
90	120	12		19500	W	A	S	NBR
90	120	12		18236	W	B	S	NBR
90	120	12		130810	W	A		FKM
90	120	12		20435	W	A		FKM
90	120	12		18235	W	B		NBR
90	120	12		48752	W	C		NBR
90	120	12		18234	W	A		NBR
90	120	12		157489	W	A	S	FKM
90	120	12		176409	W	A		FKM
90	120	13		18237	W	B		NBR
90	120	13		19502	W	A	S	NBR
90	120	13		19501	W	A		NBR
90	120	13		18238	W	B	S	NBR
90	120	13		18240	W	C	S	NBR
90	120	13		18239	W	C		NBR
90	120	13		56840	W	A		FKM
90	120	14		69273	W	A		NBR



油封

尺寸



油封

尺寸



d1	d2	H	H2	产品编码	产品组	设计型号	形式	材质
90	120	15		41124	W	A	S	NBR
90	120	15		19675	W	C		NBR
90	120	15		75829	W	A		NBR
90	120	15		69555	W	C	S	NBR
90	125	12		51839	W	A	SY	NBR
90	125	12		157269	W	A	SY	FKM
90	125	13		39994	W	A	S	NBR
90	125	13		60170	W	C		FKM
90	125	13		18241	W	B		NBR
90	125	13		18242	W	C		NBR
90	125	13		19503	W	A		NBR
90	125	14		19831	W	A		NBR
90	125	14		63494	W	A		FKM
90	125	17		42810	W	B	S	NBR
90	130	12		38445	W	A		NBR
90	130	12		39995	W	A	S	NBR
90	130	13		18244	W	C		NBR
90	130	13		121580	W	B	S	NBR
90	130	13		39996	W	A	S	NBR
90	130	13		130811	W	A		FKM
90	130	13		56970	W	C	S	NBR
90	130	13		18243	W	A		NBR
90	130	13		63503	W	A		FKM
90	135	13		39997	W	A	S	NBR
90	135	15		40428	W	C	S	NBR
90	135.7	13		19833	W	A		NBR
90	140	12		170602	W	A	S	FKM
90	140	13		171704	W	A	S	FKM
90	140	13		18245	W	C		NBR
90	140	13		19504	W	A		NBR
90	155.2	12		18246	W	A		NBR
90	160	12		35316	W	A		NBR
90	167	14		19592	W	A		NBR
90.09	119.86	24.34		38498	W	C		NBR
91	136	12		18247	W	A		NBR
91	136	12		63513	W	A		FKM
92	105	10		41125	W	A	S	NBR
92	110	12		81260	W	A		NBR
92	120	10		69554	W	C	S	NBR
92	120	12		164135	W	A		FKM
92	120	12		41126	W	A	S	NBR
92	120	12		40000	W	A		NBR
92	120	13		18248	W	C		NBR
92	120	13		18699	W	A		NBR
92	120	13		37613	W	A		FKM
92	120	14		18249	W	A		NBR
92	120	14		63487	W	A		FKM
92	145	18		19505	W	A	S	NBR
92.07	111.12	11.11		37928	W	A	S	NBR
92.07	114.3	12		90329	W	C	S	NBR
92.07	114.3	12.7		20187	W	A		NBR
92.07	114.3	12.7		59963	W	A	S	NBR
92.07	114.3	12.7		60602	W	B		NBR
92.07	117.47	12.7		59964	W	A	S	NBR
92.07	117.47	12.7		35502	W	A		NBR

Any seal. Any time.

www.dichtomatik.de



d1	d2	H	H2	产品编码	产品组	设计型号	形式	材质
92.07	117.47	15.87		38499	W	C		NBR
92.07	120.65	12.7		20188	W	A		NBR
92.07	123.82	12.7		59965	W	A	S	NBR
92.07	127	9.52		60734	W	B	S	NBR
92.07	142.87	12.7		59966	W	A	S	NBR
92.2	126.7	11.6		69553	W	C		NBR
92.25	114.3	12.7		43971	W	A		NBR
92.25	114.45	12.7		42811	W	C		NBR
93	108	7		163173	W	A		NBR
93	110	13		40427	W	C		NBR
93	115	13		22601	W	A		FKM
93	130.2	10		48753	W	C		NBR
93.66	114.45	12.7		40425	W	C		NBR
93.66	123.82	12.7		59967	W	A	S	NBR
93.66	130.18	12.7		40426	W	C		NBR
93.66	142.87	12.7		38500	W	C		NBR
93.66	142.87	12.7		59968	W	A	S	NBR
93.66	142.87	12.7		60603	W	B		NBR
94	110	10.8		19506	W	A	S	NBR
94	120	13		40424	W	C		NBR
95	110	6		83184	W	A		FKM
95	110	9		18251	W	C		NBR
95	110	9		36372	W	A		NBR
95	110	9		18250	W	B		NBR
95	110	10		83185	W	A		FKM
95	110	10		38446	W	A		NBR
95	110	10		18252	W	B		NBR
95	110	10		125902	W	A	S	FKM
95	110	10		19507	W	A	S	NBR
95	110	10		18253	W	C		NBR
95	110	10		117855	W	B	S	NBR
95	110	12		40001	W	A	S	NBR
95	110	12		63473	W	A		FKM
95	110	12		18256	W	C		NBR
95	110	12		18254	W	A		NBR
95	110	12		18255	W	B		NBR
95	110	13		18257	W	B		NBR
95	110	13		41127	W	A	S	NBR
95	110	13		44255	W	A		NBR
95	110	13		18258	W	C		NBR
95	112	12		19508	W	A	S	NBR
95	115	8		75826	W	A		NBR
95	115	9		61734	W	C		NBR
95	115	10		34363	W	C		NBR
95	115	11		160992	W	A		NBR
95	115	11		19509	W	A		NBR
95	115	12		19510	W	A	S	NBR
95	115	13		18260	W	A	S	NBR
95	115	13		22542	W	A	S	FKM
95	115	13		18259	W	A		NBR
95	115	13		62552	W	A		FKM
95	115	13		18261	W	B		NBR
95	115	13		18262	W	C		NBR
95	120	8		41129	W	A	O	NBR
95	120	10		18263	W	A	S	NBR



油封

尺寸



油封

尺寸



d1	d2	H	H2	产品编码	产品组	设计型号	形式	材质
95	120	10		130853	W	A		FKM
95	120	10		63488	W	A	S	FKM
95	120	12		36450	W	A	S	FKM
95	120	12		92212	W	C		NBR
95	120	12		157220	W	A	SY	FKM
95	120	12		18264	W	A		NBR
95	120	12		18265	W	A	S	NBR
95	120	12		20436	W	A		FKM
95	120	12		18266	W	B		NBR
95	120	12		118704	W	A	SY	NBR
95	120	12		177172	W	A		FKM
95	120	13		19511	W	A	S	NBR
95	120	13		18269	W	C		NBR
95	120	13		63489	W	A		FKM
95	120	13		60171	W	C		FKM
95	120	13		38119	W	A	S	FKM
95	120	13		130007	W	A	SY	NBR
95	120	13		153799	W	B		FKM
95	120	13		157270	W	A	SY	FKM
95	120	13		42812	W	B	S	NBR
95	120	13		20851	W	C	S	NBR
95	120	13		18267	W	A		NBR
95	120	13		18268	W	B		NBR
95	120	13		179144	W	A	S	NBR
95	120	14		42813	W	B	S	NBR
95	120	15		60186	W	C		NBR
95	125	10		51572	W	A	S	NBR
95	125	12		48756	W	C	S	NBR
95	125	12		25879	W	A	S	NBR
95	125	12		165392	W	C		NBR
95	125	12		18271	W	B		NBR
95	125	12		20751	W	A		FKM
95	125	12		22543	W	A	S	FKM
95	125	12		69236	W	A		NBR
95	125	12		18270	W	A		NBR
95	125	13		56841	W	A	S	FKM
95	125	13		63495	W	A		FKM
95	125	13		18272	W	A		NBR
95	125	13		18274	W	C		NBR
95	125	13		18273	W	B		NBR
95	125	15		41440	W	C		NBR
95	125	15		40002	W	A	S	NBR
95	125	16		41130	W	A		NBR
95	125	20		41128	W	A	S	NBR
95	127	12		18275	W	A		NBR
95	130	8		131000	W	A	S	NBR
95	130	12		38760	W	A	S	NBR
95	130	12		37596	W	A		NBR
95	130	13		40003	W	A	S	NBR
95	130	13		63504	W	A		FKM
95	130	13		18276	W	A		NBR
95	130	13		18277	W	C		NBR
95	130	13		17115	W	B		NBR
95	130	13		40159	W	B	S	NBR
95	130	15		42815	W	B	S	NBR

Any seal. Any time.

www.dichtomatik.de



d1	d2	H	H2	产品编码	产品组	设计型号	形式	材质
95	130	15		26421	W	A		NBR
95	130	15		19512	W	A	S	NBR
95	132	12		40004	W	A		NBR
95	133	14		48757	W	C		NBR
95	135	13		40504	W	A	O	NBR
95	135	13		63509	W	A		FKM
95	135	13		19513	W	A	S	NBR
95	135	13		18278	W	A		NBR
95	135	14		41131	W	A	S	NBR
95	135	20		41132	W	A	S	NBR
95	136	13		18279	W	A		NBR
95	136	13		165338	W	A	S	FKM
95	140	13		41133	W	A	S	NBR
95	145	12		179816	W	A	S	NBR
95	145	13		152197	W	A	S	FKM
95	145	13		40005	W	A	S	NBR
95	145	13		59485	W	A		NBR
95	150	15		63526	W	A		FKM
95	150	15		18280	W	A		NBR
95	160	15		18281	W	A		NBR
95	160	15		63532	W	A		FKM
95	170	13		156564	W	A		FKM
95	170.5	12		18321	W	A		NBR
95	170.5	12		63547	W	A		FKM
95	170.5	13		19819	W	A		NBR
95	180.5	13		19811	W	A		NBR
95.25	111.12	8.33		37693	W	B		NBR
95.25	111.12	8.33		37694	W	C		NBR
95.25	111.12	8.33		37692	W	A		NBR
95.25	114.3	11.91		60915	W	C	S	NBR
95.25	114.3	12.7		20189	W	A		NBR
95.25	114.3	12.7		59969	W	A	S	NBR
95.25	117.47	9.52		59970	W	A	S	NBR
95.25	120.65	12.7		19979	W	A		NBR
95.25	120.65	12.7		60735	W	B	S	NBR
95.25	120.65	12.7		60604	W	B		NBR
95.25	120.65	12.7		59971	W	A	S	NBR
95.25	127	11.11		74868	W	C		NBR
95.25	127	12.7		34877	W	A		NBR
95.25	133.35	12.7		19868	W	A		NBR
95.25	136.52	11.11		56011	W	A		NBR
95.25	136.52	13.46		60916	W	C	S	NBR
95.25	142.87	12.7		59972	W	A	S	NBR
95.5	110.97	9		176159	W	B		NBR
96	112	10		52105	W	A		NBR
96	117	10		34302	W	A		FKM
96	135.7	12		19834	W	A		NBR
96	136	12		18282	W	A		NBR
96	136	12		63514	W	A		FKM
96.83	123.82	12.7		59973	W	A	S	NBR
96.83	123.82	12.7		36956	W	A		NBR
97	114	12		135126	W	B	S	NBR
97	120	13		40423	W	C		NBR
97	123	14		41135	W	A	S	NBR
97	125	12		157310	W	A	SY	NBR



油封

尺寸



油封

尺寸



d1	d2	H	H2	产品编码	产品组	设计型号	形式	材质
97	125	12		157271	W	A	SY	FKM
97	127	13		41134	W	A		NBR
97	130	14		18283	W	A		NBR
97	130	14		63505	W	A		FKM
97	167	13		19737	W	A		NBR
97.5	120	12		41137	W	A	S	NBR
97.5	124	12		41136	W	A	S	NBR
98	120	7		163174	W	A		NBR
98	120	12		83473	W	C		NBR
98	120	13		40160	W	B	S	NBR
98	120	13		40161	W	B		NBR
98	120	13		20437	W	A		FKM
98	120	13		18284	W	A		NBR
98	120	13		144066	W	A	S	NBR
98	125	10		34700	W	A		NBR
98	125	12		41138	W	A	S	NBR
98	125	13		18454	W	A		NBR
98	125	13		34307	W	A		FKM
98	125	13		48758	W	C		NBR
98	128	10		63500	W	A		FKM
98	128	10		18285	W	A		NBR
98	130	13		27681	W	B		NBR
98	130	13		74390	W	C	S	NBR
98	180.5	13		19812	W	A		NBR
98	180.5	13		63553	W	A		FKM
98.02	136.52	12.7		60736	W	B	S	NBR
98.4	125	13		38501	W	C		NBR
98.42	123.82	12.7		21952	W	A		NBR
98.42	127	12.7		20190	W	A		NBR
98.42	127	12.7		59974	W	A	S	NBR
98.42	130.17	12.7		59975	W	A	S	NBR
98.42	133.35	12.7		20191	W	A		NBR
98.42	133.35	12.7		59976	W	A	S	NBR
98.42	136.52	12.7		59977	W	A	S	NBR
98.42	144.52	12.7		59978	W	A	S	NBR
99.85	150	12.7		35524	W	A		NBR
99.87	150.2	12.7		42816	W	B	S	NBR
100	110	5		68271	W	A	OK	NBR
100	110	7		75890	W	B	O	NBR
100	114	7		42817	W	B		NBR
100	114	10		40162	W	B		NBR
100	115	9		18286	W	A		NBR
100	115	9		63480	W	A		FKM
100	115	9		56842	W	A	S	FKM
100	115	9		167125	W	A		FKM
100	115	9		18287	W	B		NBR
100	115	15		60187	W	A	OK	NBR
100	116	12		19514	W	A	S	NBR
100	118	12		19829	W	B		NBR
100	118	12		40006	W	A	S	NBR
100	120	5.5		42818	W	B	S	NBR
100	120	5.5		42819	W	C		NBR
100	120	7.5		118705	W	A	SY	NBR
100	120	7.5		133600	W	A	SY	FKM
100	120	8		38676	W	B		NBR

Any seal. Any time.
www.dichtomatik.de



d1	d2	H	H2	产品编码	产品组	设计型号	形式	材质
100	120	8		66385	W	A	S	FKM
100	120	10		18288	W	A		NBR
100	120	10		40007	W	A	S	NBR
100	120	10		63490	W	A	S	FKM
100	120	10		18289	W	B		NBR
100	120	10		61826	W	C	S	NBR
100	120	10		131063	W	A	S	FKM
100	120	10		57141	W	A		FKM
100	120	10		18290	W	C		NBR
100	120	11		40163	W	B	S	NBR
100	120	11		19515	W	A		NBR
100	120	12		20438	W	A		FKM
100	120	12		19671	W	B		NBR
100	120	12		157272	W	A	SY	FKM
100	120	12		18291	W	A		NBR
100	120	12		19516	W	A	S	NBR
100	120	12		73238	W	A	S	FKM
100	120	12		130860	W	A		FKM
100	120	12		60188	W	B	S	NBR
100	120	12		38710	W	C		NBR
100	120	12		157311	W	A	SY	NBR
100	120	13		22602	W	A		FKM
100	120	13		62553	W	A	S	FKM
100	120	13		60333	W	B	S	NBR
100	120	13		18292	W	C		NBR
100	120	13		36623	W	B		NBR
100	120	13		40008	W	A	S	NBR
100	120	13		19517	W	A		NBR
100	120	15		42820	W	B		NBR
100	120	17		25647	W	A	S	NBR
100	125	8		41140	W	A	S	NBR
100	125	10		41139	W	A	S	NBR
100	125	10		40009	W	A		NBR
100	125	11		40164	W	B	S	NBR
100	125	12		57136	W	A	S	FKM
100	125	12		18293	W	A		NBR
100	125	12		57111	W	A		NBR
100	125	12		18294	W	B		NBR
100	125	12		20439	W	A		FKM
100	125	12		19518	W	A	S	NBR
100	125	13		18296	W	C		NBR
100	125	13		18295	W	B		NBR
100	125	13		176993	W	A		NBR
100	125	13		130008	W	A	SY	NBR
100	125	13		40165	W	B	S	NBR
100	125	13		19519	W	A		NBR
100	125	13		19520	W	A	S	NBR
100	125	13		22603	W	A		FKM
100	125	13		67999	W	C	S	NBR
100	125	15		27030	W	A		NBR
100	127	10		41141	W	A	S	NBR
100	127	13		63498	W	A		FKM
100	127	13		18297	W	A		NBR
100	130	10		93307	W	A		NBR
100	130	12		20440	W	A		FKM



油封

尺寸



油封

尺寸



d1	d2	H	H2	产品编码	产品组	设计型号	形式	材质
100	130	12		19522	W	B		NBR
100	130	12		21344	W	A	S	FKM
100	130	12		18298	W	A		NBR
100	130	12		19521	W	A	S	NBR
100	130	12		170824	W	A	S	FKM
100	130	13		63506	W	A		FKM
100	130	13		18301	W	C		NBR
100	130	13		87165	W	C	S	NBR
100	130	13		55974	W	B	S	NBR
100	130	13		40010	W	A	S	NBR
100	130	13		18299	W	A		NBR
100	130	13		18300	W	B		NBR
100	130	14		83429	W	A		NBR
100	130	14		19523	W	A	S	NBR
100	130	14		56845	W	A		FKM
100	130	15		39067	W	C	S	NBR
100	130	15		74272	W	B	S	NBR
100	130	15		19673	W	C		NBR
100	135	10		81251	W	A	S	NBR
100	135	12		36505	W	A		NBR
100	135	12		36506	W	A	S	NBR
100	135	13		36799	W	A		NBR
100	135	13		37675	W	C		NBR
100	135	13		59322	W	A	S	NBR
100	135	13		45436	W	A	S	FKM
100	135	14		40011	W	A	S	NBR
100	135	15		41142	W	A	S	NBR
100	135	15		56846	W	A	S	FKM
100	136.53	12.7		48759	W	C		NBR
100	137	11		19524	W	A	S	NBR
100	139	19		41143	W	A	S	NBR
100	140	12		40012	W	A	S	NBR
100	140	12		19525	W	A		NBR
100	140	12		179932	W	A		FKM
100	140	12		167155	W	A		NBR
100	140	13		18303	W	C		NBR
100	140	13		40013	W	A	S	NBR
100	140	13		63517	W	A		FKM
100	140	13		18302	W	A		NBR
100	150	10		171300	W	A	S	FKM
100	150	12		117915	W	A		NBR
100	150	12		61398	W	B		NBR
100	150	12		107334	W	A	S	NBR
100	150	13		63527	W	A		FKM
100	150	13		18304	W	A		NBR
100	150	13		36923	W	C		NBR
100	150	13		75071	W	A	S	NBR
100	150	13		70888	W	B		NBR
100	150	14		130981	W	A	S	NBR
100	150	15		37098	W	A		NBR
100	160	12		52481	W	A		NBR
100	160	15		48760	W	C		NBR
100	162	12		41145	W	A	S	NBR
100	180	12		149669	W	A	S	FKM
100	180	12		40014	W	A		NBR



d1	d2	H	H2	产品编码	产品组	设计型号	形式	材质
100	180	12		40015	W	A	S	NBR
100	180	13		35528	W	A		NBR
100	185	13		19817	W	A		NBR
100.01	127	12.7		35421	W	A		NBR
100.01	136.52	17.46		60605	W	B		NBR
101	114	10		41144	W	A	S	NBR
101.35	127	12.7		43950	W	A		NBR
101.57	125	13		40016	W	A	S	NBR
101.6	120.65	12.7		20830	W	A		NBR
101.6	127	7.1		42821	W	B		NBR
101.6	127	7.93		57183	W	A		NBR
101.6	127	9.52		20192	W	A		NBR
101.6	127	10.16		178440	W	A		FKM
101.6	127	11.11		107883	W	A		FKM
101.6	127	12.7		19980	W	A		NBR
101.6	127	12.7		60606	W	B		NBR
101.6	127	12.7		37201	W	C	S	NBR
101.6	127	12.7		38502	W	C		NBR
101.6	127	12.7		24260	W	A	S	NBR
101.6	127.1	12.7		48761	W	C	S	NBR
101.6	130.17	12.7		59979	W	A	S	NBR
101.6	133.35	12.7		59980	W	A	S	NBR
101.6	133.35	12.7		20193	W	A		NBR
101.6	133.35	12.7		42822	W	B	S	NBR
101.6	133.35	15.87		60737	W	B	S	NBR
101.6	133.35	15.87		20883	W	A		NBR
101.6	133.35	15.87		69029	W	C		NBR
101.6	136.68	11.13		48762	W	C		NBR
101.6	139.7	12.7		20194	W	A		NBR
101.6	139.7	12.7		56907	W	A		FKM
101.6	139.7	12.7		38618	W	C	S	NBR
101.6	139.7	12.7		39583	W	A	S	NBR
101.6	139.7	14.28		48763	W	C		NBR
101.6	146.05	12.7		84096	W	A		NBR
101.6	146.05	14.28		59435	W	C		NBR
102	115	10		52513	W	A	S	NBR
102	116	14		40166	W	B	S	NBR
102	125	13		22839	W	C		NBR
102	130	13		48764	W	C		NBR
102	135	13		26436	W	A		NBR
103	125	13		18305	W	C		NBR
104	120	13		22604	W	A		FKM
104	125	10		40018	W	A		NBR
104	125	10		24731	W	A		FKM
104	125	10		148593	W	A	S	FKM
104	130	10		52490	W	A		NBR
104	180.5	13		19813	W	A		NBR
104.77	127	12.7		21009	W	A		NBR
104.77	130.17	12.7		20832	W	A		NBR
104.77	136.39	12.7		83186	W	A		FKM
105	120	7		75014	W	B		NBR
105	120	8		132875	W	B	S	NBR
105	120	9.5		152182	W	A	S	NBR
105	120	10		38802	W	A		NBR
105	120	10		26515	W	A		NBR



油封

尺寸



油封

尺寸



d1	d2	H	H2	产品编码	产品组	设计型号	形式	材质
105	120	15		72782	W	C		NBR
105	125	10		18306	W	B		NBR
105	125	10		19526	W	A		NBR
105	125	10		158905	W	A		FKM
105	125	11.7		19527	W	A	S	NBR
105	125	12		18307	W	B		NBR
105	125	12		174458	W	A		NBR
105	125	13		18309	W	B		NBR
105	125	13		18308	W	A		NBR
105	125	13		18310	W	C		NBR
105	125	13		20752	W	A		FKM
105	125	13		56847	W	A	S	FKM
105	125	13		19528	W	A	S	NBR
105	127	10		41147	W	A	S	NBR
105	129	12		134450	W	A		FKM
105	129	12		134453	W	A	S	FKM
105	130	7.5		151718	W	A	O	FKM
105	130	7.5		56614	W	A	SY	NBR
105	130	8		66391	W	A	S	FKM
105	130	12		62554	W	A	S	FKM
105	130	12		18663	W	A	S	NBR
105	130	12		171043	W	A		FKM
105	130	12		40422	W	C		NBR
105	130	12		20441	W	A		FKM
105	130	12		18312	W	B		NBR
105	130	12		18311	W	A		NBR
105	130	12		176342	W	A		FKM
105	130	13		37962	W	A	S	FKM
105	130	13		72648	W	C		FKM
105	130	13		19530	W	A		NBR
105	130	13		60191	W	B	S	NBR
105	130	13		60192	W	A		FKM
105	130	13		19531	W	A	S	NBR
105	130	13		36624	W	B		NBR
105	130	13		18313	W	C		NBR
105	130	15		18314	W	C		NBR
105	130	15		38447	W	A		NBR
105	130	15		27040	W	A	S	NBR
105	130	15		56848	W	A		FKM
105	132	12		104331	W	A		FKM
105	135	12		48665	W	A		FKM
105	135	13		18315	W	A		NBR
105	135	13		40019	W	A	S	NBR
105	135	13		63510	W	A		FKM
105	135	14		40167	W	B		NBR
105	135	14		42823	W	B	S	NBR
105	135	14		26422	W	A		NBR
105	135	14		130009	W	A	SY	NBR
105	135	14		19532	W	A	S	NBR
105	135	15		132958	W	A		FKM
105	135	15		41148	W	A	S	NBR
105	136	13		37452	W	A	S	NBR
105	140	12		20442	W	A		FKM
105	140	12		157312	W	A	SY	NBR
105	140	12		40020	W	A	S	NBR

Any seal. Any time.

www.dichtomatik.de



d1	d2	H	H2	产品编码	产品组	设计型号	形式	材质
105	140	12		157273	W	A	SY	FKM
105	140	12		18316	W	A		NBR
105	140	12		18317	W	B		NBR
105	140	12		158752	W	A	S	FKM
105	140	13		18318	W	A		NBR
105	140	13		40021	W	A	S	NBR
105	140	13		18319	W	B		NBR
105	140	13		63518	W	A		FKM
105	140	13		19653	W	C	S	NBR
105	140	13		18320	W	C		NBR
105	140	15		41149	W	A	S	NBR
105	140	16		56611	W	A		NBR
105	145	13		18322	W	B		NBR
105	145	15		41150	W	A	S	NBR
105	145	15		40168	W	B		NBR
105	145	16		18323	W	A		NBR
105	145	16		63522	W	A		FKM
105	150	15		44798	W	A		NBR
105	150	15		40421	W	C		NBR
105	160	12		163176	W	A	S	NBR
105	160	12		170205	W	A	S	FKM
105	170.5	12		19809	W	A		NBR
105	170.5	12		63548	W	A		FKM
106	126	13		40022	W	A	S	NBR
106.36	133.35	12.7		21951	W	A		NBR
106.4	130	10		75325	W	C		NBR
107	133.5	11		42824	W	C		NBR
107	150	15		18324	W	A		NBR
107.95	122.24	7.93		158062	W	B	O	NBR
107.95	127	12.7		20195	W	A		NBR
107.95	133.35	7.93		59418	W	A	S	FKM
107.95	133.35	12.7		59981	W	A	S	NBR
107.95	133.35	12.7		36204	W	B		NBR
107.95	133.35	12.7		38097	W	A		FKM
107.95	133.35	12.7		60738	W	B	S	NBR
107.95	133.35	12.7		19981	W	A		NBR
107.95	133.38	11		127688	W	C	S	NBR
107.95	136.52	12.7		20196	W	A		NBR
107.95	139.7	12.7		59982	W	A	S	NBR
107.95	139.7	12.7		20197	W	A		NBR
107.95	139.7	14.28		83474	W	C		NBR
107.95	142.87	12.7		21026	W	A		NBR
107.95	142.87	12.7		59983	W	A	S	NBR
107.95	146.05	11.11		27066	W	A		NBR
107.95	146.05	12.7		59984	W	A	S	NBR
107.95	152.4	14.28		20198	W	A		NBR
108	130	12		40023	W	A		NBR
108	130	13		38503	W	C		NBR
108	130	13		40024	W	A		NBR
108	133.4	13		83475	W	C		NBR
108	133.5	13		41151	W	A		NBR
108	140	13		83476	W	C		NBR
108	145	15		18325	W	A		NBR
108	152.6	13		19842	W	B	S	NBR
109.59	158.75	10		118455	W	A	SY	NBR



油封

尺寸



油封

尺寸



















d1	d2	H	H2	产品编码	产品组	设计型号	形式	材质
110	125	9.5		41152	W	A	S	NBR
110	125	12		41153	W	A		NBR
110	125	13		26423	W	A		NBR
110	126	18		19533	W	A	S	NBR
110	128	9		38677	W	B		NBR
110	128	9		48666	W	A		FKM
110	128	9		18326	W	C		NBR
110	128	9		61364	W	B		FKM
110	130	8		20753	W	A		FKM
110	130	8		38448	W	A		NBR
110	130	10		68272	W	A		NBR
110	130	10		41154	W	A	S	NBR
110	130	12		20443	W	A		FKM
110	130	12		165150	W	A	S	NBR
110	130	12		157274	W	A	SY	FKM
110	130	12		38504	W	C		NBR
110	130	12		48594	W	A	SY	NBR
110	130	12		19534	W	A	S	NBR
110	130	12		56849	W	A	S	FKM
110	130	12		18327	W	A		NBR
110	130	12		18328	W	B		NBR
110	130	12		170603	W	A	S	FKM
110	130	12		176345	W	A		FKM
110	130	13		19535	W	A		NBR
110	130	13		18330	W	C		NBR
110	130	13		36783	W	B	S	NBR
110	130	13		22605	W	A		FKM
110	130	13		18329	W	A	S	NBR
110	130	13		44291	W	B		NBR
110	130	14		36246	W	A		NBR
110	130	14.5		56850	W	A		FKM
110	130	14.5		38449	W	A		NBR
110	130	15		40130	W	B		NBR
110	130	15		40025	W	A	S	NBR
110	130	15		19654	W	C		NBR
110	130	18		41155	W	A	S	NBR
110	132	12		40131	W	B		NBR
110	133.3	13		40420	W	C		NBR
110	133.5	11		41156	W	A	S	NBR
110	135	12		63511	W	A		FKM
110	135	12		70451	W	A	S	NBR
110	135	12		26424	W	A		NBR
110	135	12		19536	W	B		NBR
110	135	13		38741	W	C	S	NBR
110	135	13		40026	W	A	S	NBR
110	135	13		18331	W	A		NBR
110	135	13		18332	W	C		NBR
110	135	13		63512	W	A		FKM
110	135	14		41161	W	A	S	NBR
110	135	15		41162	W	A	S	NBR
110	140	10		56984	W	A		NBR
110	140	12		18333	W	A		NBR
110	140	12		18334	W	B		NBR
110	140	12		42642	W	A	S	FKM
110	140	12		83477	W	C		NBR

Any seal. Any time.

www.dichtomatik.de



d1	d2	H	H2	产品编码	产品组	设计型号	形式	材质	
110	140	12		130861	W	A		FKM	
110	140	12		27500	W	A	S	NBR	
110	140	12		20445	W	A		FKM	
110	140	12		155880	W	A	SY	NBR	
110	140	13		18336	W	B		NBR	
110	140	13		18338	W	C	S	NBR	
110	140	13		35013	W	A	S	NBR	
110	140	13		22606	W	A		FKM	
110	140	13		18337	W	C		NBR	
110	140	13		157281	W	A	SY	NBR	
110	140	13		69907	W	C		FKM	
110	140	13		18335	W	A		NBR	
110	140	13		40132	W	B	S	NBR	
110	140	14		44991	W	A		NBR	
110	140	14		19537	W	A	S	NBR	
110	140	14		130010	W	A	SY	NBR	
110	140	15		41163	W	A	S	NBR	
110	140	15		18339	W	C		NBR	
110	140	15.5		40419	W	C		NBR	
110	142	12		40133	W	B		NBR	
110	145	13		63523	W	A		FKM	
110	145	13		18340	W	A		NBR	
110	145	13		27464	W	C		NBR	
110	145	14		40028	W	A	S	NBR	
110	145	14		41165	W	A		NBR	
110	145	15		19538	W	A	S	NBR	
110	145	15		27035	W	A		NBR	
110	145	15		43078	W	B		NBR	
110	145	17		164515	W	A	S	FKM	
110	148	15		41164	W	A	S	NBR	
110	150	8		171354	W	A	SY	FKM	
110	150	8		118706	W	A	SY	NBR	
110	150	12		151982	W	A		NBR	
110	150	13		19655	W	B	S	NBR	
110	150	13		26445	W	A		FKM	
110	150	13		18341	W	A		NBR	
110	150	13		170606	W	A		FKM	
110	150	13		18342	W	C		NBR	
110	150	13		40029	W	A	S	NBR	
110	150	15		38505	W	C		NBR	
110	150	15		18343	W	A		NBR	
110	150	15		63528	W	A		FKM	
110	150.5	14		19840	W	A		NBR	
110	152	15		83478	W	C		NBR	
110	155	15		63531	W	A		FKM	
110	155	15		18344	W	A		NBR	
110	159	14		41166	W	A		NBR	
110	160	10		68273	W	A		NBR	
110	160	13		40030	W	A	S	NBR	
110	160	15		18345	W	A		NBR	
110	165	12		179931	W	A		FKM	
110	170	12		41167	W	A	S	NBR	
110	200	13		40031	W	A	S	NBR	
110	200	13		48667	W	A		FKM	
110	200.5	13		19818	W	A		NBR	

油封

尺寸





















油封

尺寸



d1	d2	H	H2	产品编码	产品组	设计型号	形式	材质
110.15	170	12.7		35525	W	A		NBR
111.12	136.52	12.7		59985	W	A	S	NBR
111.12	136.52	12.7		20199	W	A		NBR
111.12	139.7	12.7		20200	W	A		NBR
111.12	152.4	12.7		20201	W	A		NBR
111.12	152.4	12.7		59986	W	A	S	NBR
111.12	152.4	12.7		60879	W	C		NBR
111.25	136.65	12.7		48765	W	C		NBR
112	125	9		41168	W	A		NBR
112	130	8		21566	W	B		NBR
112	140	13		63520	W	A	S	FKM
112	140	13		63519	W	A		FKM
112	140	13		164048	W	A		NBR
112	140	13		21098	W	C		NBR
112	140	13		18346	W	A		NBR
112	142	12		40032	W	A	S	NBR
112	200	10		48767	W	C		NBR
113	140	13		19657	W	C		NBR
114	126	6		127077	W	A	S	FKM
114	127	9		41169	W	A		NBR
114	140	13		35888	W	A		NBR
114	140	13		20444	W	A		FKM
114	140	13		18347	W	C		NBR
114.3	130.17	7.93		76102	W	B	O	NBR
114.3	133.35	11.11		20833	W	A		NBR
114.3	133.35	12.7		59987	W	A	S	NBR
114.3	134.75	12.7		93374	W	A	SY	NBR
114.3	136.52	11.11		20834	W	A		NBR
114.3	139.7	9.52		20202	W	A		NBR
114.3	139.7	12.7		19982	W	A		NBR
114.3	139.7	12.7		83479	W	C		NBR
114.3	139.7	12.7		178438	W	A		FKM
114.3	139.7	12.7		160018	W	C	S	NBR
114.3	139.7	12.7		59988	W	A	S	NBR
114.3	139.7	12.7		60607	W	B		NBR
114.3	142.87	12.7		20857	W	A		NBR
114.3	146.05	12.7		20203	W	A		NBR
114.3	146.05	12.7		59989	W	A	S	NBR
114.3	146.05	12.7		60608	W	B		NBR
114.3	146.05	22.22		68161	W	C		NBR
114.3	146.43	21.84		37748	W	A	S	NBR
114.3	152.4	12.7		59990	W	A	S	NBR
114.3	152.4	19.05		40418	W	C		NBR
114.3	155.57	14.28		37197	W	A		NBR
114.3	155.57	14.28		44486	W	A	S	NBR
114.3	158.75	12.7		59991	W	A	S	NBR
114.3	158.75	14.28		59992	W	A	S	NBR
114.3	174.62	14.28		38024	W	A	S	NBR
115	130	12		18348	W	A		NBR
115	130	12		63507	W	A		FKM
115	130	13		18349	W	B		NBR
115	130	13		44854	W	A		NBR
115	135	9		83187	W	A		FKM
115	135	9		69546	W	C		FKM
115	135	10		57142	W	A		FKM



d1	d2	H	H2	产品编码	产品组	设计型号	形式	材质	
115	135	13		27685	W	B		NBR	
115	135	14		41170	W	A	S	NBR	
115	137	9		36719	W	A		FKM	
115	140	10		38450	W	A		NBR	
115	140	10		56851	W	A		FKM	
115	140	12		18351	W	B		NBR	
115	140	12		38471	W	A	S	NBR	
115	140	12		20446	W	A		FKM	
115	140	12		18350	W	A		NBR	
115	140	12		22544	W	A	S	FKM	
115	140	12		18352	W	C		NBR	
115	140	13		69915	W	B	S	NBR	
115	140	13		34841	W	A	S	NBR	
115	140	13		18354	W	B		NBR	
115	140	13		20756	W	C	S	NBR	
115	140	13		18353	W	A		NBR	
115	140	13		18355	W	C		NBR	
115	140	15		18356	W	C		NBR	
115	140	15		38678	W	B		NBR	
115	140	16		63442	W	B	S	NBR	
115	145	13		63524	W	A		FKM	
115	145	13		18357	W	A		NBR	
115	145	14		19539	W	A		NBR	
115	145	14		19540	W	A	S	NBR	
115	145	14		134219	W	A	SY	NBR	
115	145	15		60195	W	A		NBR	
115	145	16		48768	W	C	S	NBR	
115	150	12		36452	W	A	S	FKM	
115	150	12		36549	W	A	S	NBR	
115	150	12		36451	W	A		FKM	
115	150	12		18358	W	A		NBR	
115	150	13		40417	W	C	S	NBR	
115	150	13		40134	W	B	S	NBR	
115	150	13		18359	W	A		NBR	
115	150	13		18360	W	C		NBR	
115	150	13		39254	W	A	S	NBR	
115	150	15		19541	W	A	S	NBR	
115	150	15		83324	W	C	S	NBR	
115	150	15		40135	W	B	S	NBR	
115	150	15		18361	W	C		NBR	
115	150	16		48769	W	C		NBR	
115	151	10		41171	W	A	S	NBR	
115	152	15		175114	W	A	S	NBR	
115	160	15		18362	W	A		NBR	
115	160	15		63533	W	A		FKM	
115	160	15		40416	W	C		NBR	
115	165	15		41172	W	A	S	NBR	
115	170.5	13		19810	W	A		NBR	
115	170.5	13		63549	W	A		FKM	
115	180.5	13		19814	W	A		NBR	
115	190	15		38025	W	A		NBR	
115	190	15		38026	W	B		NBR	
116	132	12		40136	W	B	S	NBR	
116	132	12		40034	W	A	S	NBR	
116	160	13		163180	W	A	S	NBR	

油封

尺寸



油封

尺寸

















d1	d2	H	H2	产品编码	产品组	设计型号	形式	材质
				25985	W	A		NBR
117.47	142.87	12.7		59993	W	A	S	NBR
117.47	142.87	12.7		35399	W	A		NBR
117.47	146.05	14.28		35927	W	C		NBR
117.47	146.05	14.28		38619	W	C	S	NBR
117.47	152.4	12.7		84945	W	C		NBR
117.5	152	16		43079	W	C	S	NBR
118	136	13		18363	W	B		NBR
118	140	13		40035	W	A	S	NBR
118	140	13		159656	W	A	S	FKM
118	140	13		18685	W	A		NBR
118	150	12		48770	W	C	S	NBR
119	140	15		38506	W	C		NBR
119.06	149.23	12.7		60880	W	C		NBR
120	135	4		133244	W	C	O	NBR
120	135	12		83188	W	A		FKM
120	140	7.5		133602	W	A	SY	FKM
120	140	7.5		118707	W	A	SY	NBR
120	140	10		118708	W	A	SY	NBR
120	140	10		26457	W	A		NBR
120	140	10		35046	W	A		FKM
120	140	10		38507	W	C		NBR
120	140	10.5		40137	W	B	S	NBR
120	140	12		40638	W	A	S	NBR
120	140	12		62555	W	A	S	FKM
120	140	12		44244	W	A		NBR
120	140	12		116428	W	A		FKM
120	140	13		18365	W	B		NBR
120	140	13		38695	W	B	S	NBR
120	140	13		36844	W	A	S	NBR
120	140	13		34693	W	C	S	NBR
120	140	13		18364	W	A		NBR
120	140	13		157313	W	A	SY	NBR
120	140	13		56853	W	A	S	FKM
120	140	13		48668	W	A	SY	FKM
120	140	13		18366	W	C		NBR
120	140	13		20447	W	A		FKM
120	140	14		44256	W	A		NBR
120	140	14		40036	W	A	S	NBR
120	145	12		19542	W	A		NBR
120	145	12		40038	W	A	S	NBR
120	145	12.5		41173	W	A	S	NBR
120	145	13		40039	W	A	S	NBR
120	145	13		40415	W	C		NBR
120	145	14.5		60196	W	C		NBR
120	145	15		56009	W	B	S	NBR
120	145	15		56650	W	A	S	NBR
120	145	15		38709	W	C		NBR
120	145	15.5		41174	W	A	S	NBR
120	146	16		43080	W	C		NBR
120	150	10		155881	W	A	SY	NBR
120	150	10		157221	W	A	SY	FKM
120	150	12		38696	W	B	S	NBR
120	150	12		18367	W	A		NBR
120	150	12		18368	W	B		NBR

Any seal. Any time.

www.dichtomatik.de



d1	d2	H	H2	产品编码	产品组	设计型号	形式	材质	
120	150	12		22545	W	A	S	FKM	
120	150	12		157314	W	A	SY	NBR	
120	150	12		38472	W	A	S	NBR	
120	150	12		20448	W	A		FKM	
120	150	12		171618	W	A	S	NBR	
120	150	12		40414	W	C		NBR	
120	150	12		127105	W	C	S	FKM	
120	150	12		172763	W	A	S	FKM	
120	150	12		157275	W	A	SY	FKM	
120	150	13		18369	W	A		NBR	
120	150	13		18370	W	B		NBR	
120	150	13		57149	W	A	S	FKM	
120	150	13		163358	W	C		NBR	
120	150	13		40138	W	B	S	NBR	
120	150	13		18371	W	C		NBR	
120	150	13		20754	W	A		FKM	
120	150	13		40040	W	A	S	NBR	
120	150	14		19543	W	A	S	NBR	
120	150	14		134220	W	A	SY	NBR	
120	150	15		38473	W	A	S	NBR	
120	150	15		19544	W	A		NBR	
120	150	15		38742	W	C	S	NBR	
120	150	15		48669	W	A	SY	FKM	
120	150	15		18372	W	C		NBR	
120	150	15		19658	W	B		NBR	
120	150	15		56854	W	A	S	FKM	
120	150	15		62556	W	A		FKM	
120	150	15		20449	W	C		FKM	
120	150	15		157315	W	A	SY	NBR	
120	150	16		41175	W	A	S	NBR	
120	150	16		83733	W	A		FKM	
120	150	18		41304	W	A	S	NBR	
120	150.5	13		19841	W	A		NBR	
120	152	16		83480	W	C		NBR	
120	155	12		41305	W	A	S	NBR	
120	155	15		40041	W	A	S	NBR	
120	155	16		48771	W	C	S	NBR	
120	155	16		41306	W	A	S	NBR	
120	160	12		37181	W	A	S	NBR	
120	160	12		26037	W	B		NBR	
120	160	12		62557	W	A	S	FKM	
120	160	12		56855	W	A		FKM	
120	160	12		18686	W	A		NBR	
120	160	13		40042	W	A	S	NBR	
120	160	13		18374	W	C		NBR	
120	160	13		18373	W	A		NBR	
120	160	13		63534	W	A		FKM	
120	160	13		60172	W	C		FKM	
120	160	14		44241	W	A		NBR	
120	160	15		20450	W	A		FKM	
120	160	15		18376	W	C		NBR	
120	160	15		38247	W	A	S	NBR	
120	160	15		18375	W	A		NBR	
120	160	17		46169	W	B		NBR	
120	170	15		40413	W	C		NBR	

油封

尺寸





















油封

尺寸



d1	d2	H	H2	产品编码	产品组	设计型号	形式	材质
120	180	15		128141	W	A	S	NBR
120	195	13		26425	W	A		NBR
120	215	12		152024	W	A	S	NBR
120.25	146.1	14.2		70395	W	A	S	NBR
120.65	139.7	9.52		20856	W	A		NBR
120.65	139.7	12.7		19983	W	A		NBR
120.65	146.05	9.52		59995	W	A	S	NBR
120.65	146.05	12.7		60609	W	B		NBR
120.65	146.05	12.7		59994	W	A	S	NBR
120.65	146.05	12.7		20204	W	A		NBR
120.65	152.4	12.7		37775	W	A		NBR
120.65	152.4	14.2		20205	W	A		NBR
120.65	152.4	14.28		24217	W	A		NBR
120.65	152.4	14.28		60610	W	B		NBR
120.65	152.4	14.28		59996	W	A	S	NBR
120.65	152.4	22.22		74311	W	B	S	NBR
120.65	168.27	12.7		38092	W	A		NBR
122	150	13		40412	W	C		NBR
122	150	15		83481	W	C		NBR
122	150	15		18377	W	A		NBR
123.82	158.75	14.28		43081	W	C	S	NBR
123.82	158.75	14.28		59997	W	A	S	NBR
124	150	15		48772	W	C		NBR
125	140	7		84929	W	B	O	NBR
125	140	10		38451	W	A		NBR
125	140	10		26516	W	A		NBR
125	140	10		56856	W	A		FKM
125	142	13		38131	W	A	S	NBR
125	143	12		38251	W	A		NBR
125	143	13		38132	W	A	S	NBR
125	143	13		85481	W	C	S	NBR
125	145	7.5		69856	W	A		NBR
125	150	10		92940	W	C	S	NBR
125	150	12		159789	W	A	S	NBR
125	150	12		38249	W	C		NBR
125	150	12		38679	W	B		NBR
125	150	12		22546	W	A	S	FKM
125	150	12		20451	W	A		FKM
125	150	12		18378	W	A		NBR
125	150	12		131065	W	A	S	FKM
125	150	12		38474	W	A	S	NBR
125	150	13		26253	W	A		NBR
125	150	13		38743	W	C	S	NBR
125	150	13		40044	W	A	S	NBR
125	150	13		18380	W	C		NBR
125	150	13		19659	W	B		NBR
125	150	13		18379	W	B	S	NBR
125	150	13		63529	W	A		FKM
125	150	13		158996	W	A		NBR
125	150	14		40045	W	A	S	NBR
125	150	14		40169	W	B	S	NBR
125	150	14		61439	W	A		NBR
125	150	15		38708	W	C		NBR
125	150	15		62558	W	A		FKM
125	150	15		18381	W	A		NBR



d1	d2	H	H2	产品编码	产品组	设计型号	形式	材质	
125	152.4	15		40046	W	A	S	NBR	
125	152.4	15		56010	W	C	S	NBR	
125	152.4	15		20217	W	C		NBR	
125	155	12		56858	W	A	S	FKM	
125	155	12		38452	W	A		NBR	
125	155	12		38475	W	A	S	NBR	
125	155	12		56857	W	A		FKM	
125	155	14		43082	W	B	S	NBR	
125	155	14		134221	W	A	SY	NBR	
125	155	14		40047	W	A	S	NBR	
125	155	15		41308	W	A	S	NBR	
125	160	12		40048	W	A	S	NBR	
125	160	12		20479	W	A		FKM	
125	160	12		81884	W	B		NBR	
125	160	12		18687	W	A		NBR	
125	160	13		44257	W	A		NBR	
125	160	13		18382	W	C		NBR	
125	160	13		57315	W	B		NBR	
125	160	15		18384	W	C		NBR	
125	160	15		41309	W	A	S	NBR	
125	160	15		38744	W	C	S	NBR	
125	160	15		63535	W	A		FKM	
125	160	15		18383	W	A		NBR	
125	162	12		92941	W	C	S	NBR	
125	162	15		83482	W	C		NBR	
125	165	15		41310	W	A	S	NBR	
125	170	13		38707	W	C		NBR	
125	170	15		18385	W	C		NBR	
125	180.5	13		19815	W	A		NBR	
125.41	152.4	12.7		35400	W	A		NBR	
126	146	10		163182	W	A	S	NBR	
126	146	13		163183	W	A	S	NBR	
127	146.05	11.11		59729	W	A		NBR	
127	146.05	12.7		20206	W	A		NBR	
127	150	13		40050	W	A		NBR	
127	152.4	12.7		59998	W	A	S	NBR	
127	152.4	12.7		56859	W	A		FKM	
127	152.4	12.7		38508	W	C		NBR	
127	152.4	12.7		19984	W	A		NBR	
127	152.4	12.7		78175	W	C	S	NBR	
127	152.4	14.28		59730	W	A		NBR	
127	158.75	14.28		60611	W	B		NBR	
127	158.75	14.28		43083	W	C		NBR	
127	158.75	14.28		59999	W	A	S	NBR	
127	158.75	14.28		60917	W	C	S	NBR	
127	158.75	15.87		48491	W	C		NBR	
127	160	16		43084	W	C	S	NBR	
127	161.92	15.87		78423	W	A	S	NBR	
127	165.1	12.7		60000	W	A	S	NBR	
127	165.1	12.7		20207	W	A		NBR	
127	170	14		19316	W	A		NBR	
127	170	14		63542	W	A		FKM	
128	146	13.5		48670	W	A	S	FKM	
128	146	13.5		73353	W	A	S	NBR	
128	146	13.5		18386	W	A		NBR	

油封

尺寸





















油封

尺寸



d1	d2	H	H2	产品编码	产品组	设计型号	形式	材质
128	146	13.5		63525	W	A		FKM
128	148	14		40051	W	A	S	NBR
128	150	13		27680	W	A		NBR
128	150	13		22607	W	A		FKM
128	150	14		18387	W	A		NBR
128	150	15		40170	W	B		NBR
128	150	15		38509	W	C		NBR
128	158	20		56860	W	A		FKM
128	158	20		52926	W	A		NBR
128.57	160	14		40052	W	A	S	NBR
128.58	200.02	12.7		35053	W	A		NBR
129.77	155.32	12.7		60881	W	C		NBR
130	140	10		41396	W	A		NBR
130	150	7.5		118709	W	A	SY	NBR
130	150	10		43085	W	B		NBR
130	150	10		44888	W	A	S	NBR
130	150	10		38453	W	A		NBR
130	150	10		56861	W	A		FKM
130	150	12		56862	W	A	S	FKM
130	150	12		38476	W	A	S	NBR
130	150	13		126322	W	A		FKM
130	150	13		43086	W	B	S	NBR
130	150	14		56732	W	C		NBR
130	150	14		39052	W	B	S	NBR
130	150	14		153800	W	B		FKM
130	150	15		48672	W	A	S	FKM
130	150	15		83451	W	A	S	NBR
130	155	10		38745	W	C	S	NBR
130	155	10		59789	W	B		NBR
130	155	10		170199	W	A		FKM
130	155	10		36925	W	C		NBR
130	155	12		83483	W	C		NBR
130	158.75	13		41307	W	A	S	NBR
130	160	7.5		144300	W	A	SY	NBR
130	160	12		18388	W	A		NBR
130	160	12		34870	W	A		FKM
130	160	12		48676	W	A	SY	FKM
130	160	12		18389	W	B		NBR
130	160	12		38864	W	A	S	NBR
130	160	12		170604	W	A		FKM
130	160	12		73239	W	A	S	FKM
130	160	12		157316	W	A	SY	NBR
130	160	12		130865	W	A		FKM
130	160	13		37111	W	B	S	NBR
130	160	13		44292	W	B		NBR
130	160	13		40054	W	A	S	NBR
130	160	13		18390	W	C		NBR
130	160	13		22356	W	A		NBR
130	160	13		20478	W	A		FKM
130	160	14		19545	W	A	S	NBR
130	160	14		39053	W	B	S	NBR
130	160	14		65688	W	A		NBR
130	160	14		134222	W	A	SY	NBR
130	160	15		40171	W	B		NBR
130	160	15		22220	W	C	S	NBR



d1	d2	H	H2	产品编码	产品组	设计型号	形式	材质	
130	160	15		22547	W	A	S	FKM	
130	160	15		20452	W	A		FKM	
130	160	15		19546	W	A	S	NBR	
130	160	15		18391	W	A		NBR	
130	160	15		18392	W	C		NBR	
130	160	16		79318	W	B		NBR	
130	162	9		41311	W	A	S	NBR	
130	163	18		41312	W	A	S	NBR	
130	165	13		40055	W	A		NBR	
130	165	13		40450	W	C		NBR	
130	165	13		63539	W	A		FKM	
130	165	13		130804	W	A		FKM	
130	165	15		44258	W	A		NBR	
130	170	12		18393	W	A		NBR	
130	170	12		62559	W	A	S	FKM	
130	170	12		35701	W	A		FKM	
130	170	13		22357	W	A		NBR	
130	170	13		40172	W	B	S	NBR	
130	170	13		18394	W	C		NBR	
130	170	13		22608	W	A		FKM	
130	170	14		44259	W	A		NBR	
130	170	15		63543	W	A		FKM	
130	170	15		18395	W	A		NBR	
130	170	15		21953	W	C	S	NBR	
130	170	15		40173	W	B		NBR	
130	170	15		35102	W	C		NBR	
130	170	16		83484	W	C		NBR	
130	180	15		165199	W	C		FKM	
130	180	15		18397	W	C		NBR	
130	180	15		169998	W	C		FKM	
130	180	15		18396	W	B		NBR	
130	182	16		63554	W	A		FKM	
130	182	16		19816	W	A		NBR	
130	230	14		143318	W	A		FKM	
130	230	14		40057	W	A		NBR	
130	230	14		170176	W	A	S	FKM	
130	230	14		40056	W	A	S	NBR	
130	230	15		48677	W	A		FKM	
130.17	155.57	12.7		60001	W	A	S	NBR	
130.17	155.57	12.7		26454	W	A		NBR	
130.17	161.92	12.7		60181	W	C		NBR	
131	145	7		175301	W	A		FKM	
132	160	13		38706	W	C		NBR	
132	160	13		38746	W	C	S	NBR	
132	160	15		40451	W	C		NBR	
132.5	155.6	13		83430	W	A		NBR	
133	159	6		41410	W	A	O	NBR	
133	160	15		19548	W	A	S	NBR	
133	165	16		43087	W	C	S	NBR	
133.35	155.57	13.95		60612	W	B		NBR	
133.35	155.57	14.28		40174	W	B		NBR	
133.35	158.75	12.7		60002	W	A	S	NBR	
133.35	158.75	12.7		36628	W	A		NBR	
133.35	158.75	12.7		77867	W	C		NBR	
133.35	158.75	14.28		144070	W	A		NBR	

油封

尺寸





















油封

尺寸



d1	d2	H	H2	产品编码	产品组	设计型号	形式	材质
133.35	158.75	14.28		134608	W	C		NBR
133.35	158.75	14.28		60613	W	B		NBR
133.35	165.1	12.7		83485	W	C		NBR
133.35	165.1	14.28		60003	W	A	S	NBR
133.35	165.1	14.28		20208	W	A		NBR
133.35	165.1	15.87		60918	W	C	S	NBR
133.35	165.1	15.87		43088	W	B	S	NBR
133.35	171.45	15.87		38215	W	A		NBR
134.94	161.92	12.7		63538	W	A		FKM
135	155	12		22627	W	A		NBR
135	155	13		38705	W	C		NBR
135	160	12		130841	W	A		FKM
135	160	12		22358	W	A		NBR
135	160	12		22609	W	A		FKM
135	160	12		176412	W	A		FKM
135	160	12		134454	W	A	S	FKM
135	160	12		40058	W	A	S	NBR
135	160	13		18398	W	A		NBR
135	160	13		40059	W	A	S	NBR
135	160	13		44987	W	B		NBR
135	160	13		18399	W	C		NBR
135	160	13		63536	W	A		FKM
135	160	13		127333	W	A	SY	NBR
135	160	14		69274	W	A		NBR
135	160	15		83198	W	A	S	FKM
135	160	15		18401	W	B		NBR
135	160	15		19549	W	A	S	NBR
135	160	15		18400	W	A		NBR
135	160	15		18402	W	C		NBR
135	162	13		19229	W	B	S	NBR
135	165	12		63540	W	A		FKM
135	165	12		18403	W	A		NBR
135	165	12		171651	W	A		FKM
135	165	12		69432	W	A	S	NBR
135	165	13		19643	W	C		NBR
135	165	13		72457	W	A	S	NBR
135	165	14		41412	W	A	O	NBR
135	165	14		40060	W	A	S	NBR
135	165	14		153801	W	B		FKM
135	165	14		134223	W	A	SY	NBR
135	165	15		60183	W	A		NBR
135	165	15		60467	W	A		FKM
135	165	15		41313	W	A	S	NBR
135	165	15		40453	W	C		NBR
135	170	10		158764	W	A	S	FKM
135	170	12		156980	W	A	O	FKM
135	170	12		151719	W	A	O	FKM
135	170	12		75120	W	B		NBR
135	170	12		19550	W	A		NBR
135	170	12		37462	W	A		FKM
135	170	12		19551	W	A	S	NBR
135	170	12		179435	W	A	S	FKM
135	170	13		60175	W	C		FKM
135	170	13		40454	W	C		NBR
135	170	14		40061	W	A	S	NBR



d1	d2	H	H2	产品编码	产品组	设计型号	形式	材质	
135	170	15		36455	W	A		FKM	
135	170	15		36456	W	A	S	FKM	
135	170	15		22113	W	C		NBR	
135	170	15		41397	W	A		NBR	
135	170	15		36552	W	A	S	NBR	
135	170	15		40175	W	B		NBR	
135	170	18		44748	W	A		NBR	
135	170	18		127392	W	B		NBR	
135	175	15		40176	W	B		NBR	
135	180	15		26383	W	A		NBR	
135	190	14		40062	W	A		NBR	
135	190	15		18404	W	A		NBR	
135	192	16		18405	W	A		NBR	
135	200	19		163102	W	C		NBR	
136.52	161.92	12.7		60004	W	A	S	NBR	
136.52	161.92	12.7		27003	W	A		NBR	
136.52	165.1	12.7		20209	W	A		NBR	
138	158	10		163185	W	A	S	NBR	
138	160	15		180043	W	A	S	NBR	
138	160	15		56863	W	A		FKM	
138	160	15		55997	W	C		NBR	
138	160	15		34837	W	A		NBR	
138.12	165.1	12.7		26564	W	A		NBR	
139.7	158.75	12.7		20210	W	A		NBR	
139.7	158.75	12.7		60739	W	B	S	NBR	
139.7	160.35	30.17		60919	W	C	S	NBR	
139.7	165.1	12.7		83486	W	C		NBR	
139.7	165.1	12.7		20214	W	A		NBR	
139.7	165.1	12.7		92942	W	C	S	NBR	
139.7	165.1	12.7		60005	W	A	S	NBR	
139.7	171.45	12.7		59731	W	A		NBR	
139.7	171.45	15		43089	W	C	S	NBR	
139.7	174.6	14.28		83487	W	C		NBR	
139.7	184.15	15.87		74369	W	C		NBR	
139.7	215.9	15.87		38784	W	A		NBR	
140	157	8		126926	W	A	S	FKM	
140	160	10		118710	W	A	SY	NBR	
140	160	10		68275	W	A		NBR	
140	160	12		36845	W	A	S	NBR	
140	160	12		177024	W	A		FKM	
140	160	12		44940	W	B		NBR	
140	160	13		48774	W	C	S	NBR	
140	160	13		40063	W	A	S	NBR	
140	160	13		40177	W	B	S	NBR	
140	160	13		18407	W	B		NBR	
140	160	13		18408	W	C		NBR	
140	160	13		127396	W	A	S	FKM	
140	160	13		18406	W	A		NBR	
140	160	13		149918	W	A		FKM	
140	160	14		40178	W	B	S	NBR	
140	160	15		44260	W	A		NBR	
140	160	15		19661	W	C		NBR	
140	162	12		57143	W	A		FKM	
140	162	12		41314	W	A	S	NBR	
140	165	12		53093	W	A		NBR	

油封

尺寸





















油封

尺寸



d1	d2	H	H2	产品编码	产品组	设计型号	形式	材质
140	165	12		158763	W	A	S	FKM
140	165	12		18409	W	C		NBR
140	165	12		79560	W	A		FKM
140	165	12.5		48775	W	C		NBR
140	165	14		40179	W	B	S	NBR
140	165	15		56476	W	A		FKM
140	165	15		34888	W	C		NBR
140	165	15		44261	W	A		NBR
140	165	15		20500	W	B		FKM
140	165	15		131079	W	A	S	NBR
140	165	16		56501	W	A		FKM
140	170	12		38477	W	A	S	NBR
140	170	12		92943	W	C	S	NBR
140	170	12		130985	W	A	S	FKM
140	170	12		130858	W	A		FKM
140	170	12		22548	W	A	S	FKM
140	170	12		38656	W	A		FKM
140	170	12		38510	W	C		NBR
140	170	12		18410	W	A		NBR
140	170	13		63544	W	A		FKM
140	170	13		40065	W	A		NBR
140	170	13		37164	W	A	S	FKM
140	170	13		18411	W	C		NBR
140	170	13		160710	W	A	S	NBR
140	170	13		176410	W	A		FKM
140	170	13		40064	W	A	S	NBR
140	170	14		44262	W	A		NBR
140	170	14		19994	W	A	S	NBR
140	170	14		40180	W	B	S	NBR
140	170	14			W	A	SY	NBR
140	170	14		134224				
140	170	14		18412	W	C		NBR
140	170	14		60178	W	A	S	FKM
140	170	15		19761	W	C	S	NBR
140	170	15		37182	W	A	S	NBR
140	170	15			W	A		NBR
140	170	15		18413				
140	170	15		56864	W	A	S	FKM
140	170	15		157222	W	A	SY	FKM
140	170	15		18414	W	B		NBR
140	170	15		18415	W	C		NBR
140	170	15		20453	W	A		FKM
140	170	15		48596	W	A	SY	NBR
140	170	15		131067	W	A	S	FKM
140	170	16		41315	W	A	S	NBR
140	170	18		37263	W	A		NBR
140	175	13		38697	W	B	S	NBR
140	175	15		42628	W	B		NBR
140	175	15		37356	W	A	S	NBR
140	175	16		40066	W	A	S	NBR
140	180	12		19553	W	A		NBR
140	180	12		44108	W	C		FKM
140	180	12		157282	W	A	SY	NBR
140	180	12		40067	W	A	S	NBR
140	180	12		157223	W	A	SY	FKM
140	180	12		56865	W	A		FKM
140	180	12		130838	W	A		FKM



d1	d2	H	H2	产品编码	产品组	设计型号	形式	材质	
140	180	13		69909	W	C		FKM	
140	180	13		25848	W	A		FKM	
140	180	13		38454	W	A		NBR	
140	180	14		65689	W	A		NBR	
140	180	15		81016	W	B	S	NBR	
140	180	15		40068	W	A	S	NBR	
140	180	15		20480	W	A		FKM	
140	180	15		19611	W	C		NBR	
140	180	15		156268	W	A	S	FKM	
140	180	15		19554	W	A		NBR	
140	190	15		176380	W	C		NBR	
140	190	15		83488	W	C		NBR	
140	190	15		160370	W	C		NBR	
140	210	15		125484	W	A	S	NBR	
140.2	158.75	12.7		60006	W	A	S	NBR	
142	157	10		124771	W	A	S	NBR	
142.87	165.1	12.7		20211	W	A		NBR	
142.87	168.27	12.7		20858	W	A		NBR	
142.87	171.45	14.28		34761	W	A		NBR	
142.87	177.8	12.7		59732	W	A		NBR	
142.87	177.8	12.7		60007	W	A	S	NBR	
143	167	13		59492	W	A	S	NBR	
143	170	10		83489	W	C		NBR	
143	175	16		74410	W	A		NBR	
144	160	12		40069	W	A	S	NBR	
144	160	12		19152	W	A		NBR	
144	160	12		63537	W	A		FKM	
144	160	25		41316	W	A	S	NBR	
144.5	165	13		48678	W	A		FKM	
144.8	175	12		38511	W	C		NBR	
145	160	10		44092	W	A		NBR	
145	165	13		19663	W	C		NBR	
145	165	13		19239	W	A		NBR	
145	165	13		174270	W	C		FKM	
145	165	13		63541	W	A		FKM	
145	165	15		40456	W	C		NBR	
145	165	15		44263	W	A		NBR	
145	167	13		85482	W	C	S	NBR	
145	167	13		19347	W	A	S	NBR	
145	170	10		83490	W	C		NBR	
145	170	12		40070	W	A	S	NBR	
145	170	13		19662	W	C		NBR	
145	170	13		18417	W	B	S	NBR	
145	170	13		152743	W	A	S	NBR	
145	170	13		18416	W	B		NBR	
145	170	14		43091	W	B	S	NBR	
145	170	15		53106	W	A	S	NBR	
145	170	15		40181	W	B		NBR	
145	170	15		18419	W	C		NBR	
145	170	15		63545	W	A		FKM	
145	170	15		48679	W	A	S	FKM	
145	170	15		18418	W	A		NBR	
145	170	18		43090	W	B	S	NBR	
145	175	12		41398	W	A		NBR	
145	175	13		40182	W	B	S	NBR	

油封

尺寸



油封

尺寸



d1	d2	H	H2	产品编码	产品组	设计型号	形式	材质
145	175	13		78711	W	C		NBR
145	175	13		35287	W	B		NBR
145	175	13		35387	W	C		NBR
145	175	13		78744	W	C		FKM
145	175	14		19555	W	B	S	NBR
145	175	14		89906	W	A	S	NBR
145	175	14		78712	W	B	S	NBR
145	175	15		170877	W	A	S	FKM
145	175	15		38704	W	C		NBR
145	175	15		20477	W	A		FKM
145	175	15		40072	W	A	S	NBR
145	175	15		170868	W	A		FKM
145	175	15		18420	W	A		NBR
145	175	15		169950	W	A		NBR
145	180	12		40073	W	A	S	NBR
145	180	12		19556	W	A		NBR
145	180	12		20755	W	A		FKM
145	180	13		21585	W	A		NBR
145	180	13		20485	W	A		FKM
145	180	13		43092	W	C		NBR
145	180	14		22359	W	A		NBR
145	180	14		22610	W	A		FKM
145	180	14		57009	W	C		FKM
145	180	15		40183	W	B	S	NBR
145	180	15		20634	W	C		NBR
145	180	15		48776	W	C	S	NBR
145	184	15		151519	W	A	S	FKM
145	185	15		74657	W	A		NBR
146	163	7		53969	W	A		NBR
146	163	7		92182	W	A		FKM
146	170	15		48777	W	C		NBR
146	170	18		40184	W	B	S	NBR
146	170	18		40185	W	B		NBR
146	193.7	10		118456	W	A	SY	NBR
146	225	20		41317	W	A	S	NBR
146.05	168.28	15.87		83813	W	C	S	NBR
146.05	168.28	19.05		92944	W	C	S	NBR
146.05	171.45	12.7		19987	W	A		NBR
146.05	171.45	12.7		37610	W	C		NBR
146.05	171.5	14.28		83558	W	C	S	NBR
146.05	174.5	12.7		38512	W	C		NBR
146.05	177.8	12.7		60008	W	A	S	NBR
146.05	177.8	12.7		44459	W	B		NBR
146.05	177.8	12.7		159356	W	A		FKM
146.05	177.8	12.7		24426	W	A		NBR
146.05	177.8	15.87		37230	W	C		FKM
146.05	177.8	15.87		60882	W	C		NBR
147.64	174.63	12.7		26483	W	A		NBR
148	170	14		36846	W	A	S	NBR
148	170	14.5		37909	W	C	S	NBR
148	170	14.5		56866	W	A		FKM
148	170	14.5		38455	W	A		NBR
148	170	15		18421	W	C		NBR
148	170	15		74040	W	A	S	NBR
148	170	18		41318	W	A	S	NBR



d1	d2	H	H2	产品编码	产品组	设计型号	形式	材质
148	180	15		40457	W	C		NBR
148	190	15		40458	W	C		NBR
149	170	14.5		92945	W	C	S	NBR
149	180	15		38539	W	C		NBR
149.22	171.45	15.87		56023	W	A		NBR
149.22	177.8	12.7		37626	W	A		NBR
149.5	180	13		48682	W	A		FKM
150	162	9		41512	W	A		NBR
150	164	16		41399	W	A		NBR
150	168	12		18422	W	A		NBR
150	168	13		18423	W	B		NBR
150	168	13		39234	W	A		NBR
150	168	13		37600	W	A	S	NBR
150	170	10		180009	W	A	S	NBR
150	170	12		20475	W	A		FKM
150	170	12		21586	W	A		NBR
150	170	12		130772	W	A		FKM
150	170	13		19764	W	A		NBR
150	170	15		40074	W	A	S	NBR
150	170	15		90050	W	B	S	NBR
150	170	15		92966	W	A		NBR
150	170	15		18424	W	A		NBR
150	170	15		19664	W	C		NBR
150	170	15		63546	W	A		FKM
150	170	15		82952	W	C	S	NBR
150	178	12		54377	W	A	S	NBR
150	180	8.5		118711	W	A	SY	NBR
150	180	10		90735	W	A	S	FKM
150	180	12		38702	W	C		NBR
150	180	12		18425	W	A		NBR
150	180	12		56867	W	A		FKM
150	180	12		108665	W	A	S	NBR
150	180	13		57137	W	A	S	FKM
150	180	13		19665	W	A		NBR
150	180	13		40075	W	A	S	NBR
150	180	13		18427	W	C		NBR
150	180	13		20469	W	A		FKM
150	180	13		18426	W	B		NBR
150	180	13		19666	W	C	S	NBR
150	180	14		153806	W	B	S	NBR
150	180	14		41413	W	A	O	NBR
150	180	14		63550	W	A	S	FKM
150	180	14		41401	W	A		NBR
150	180	14		40076	W	A	S	NBR
150	180	14		40186	W	B		NBR
150	180	14		134225	W	A	SY	NBR
150	180	15		69508	W	A	S	FKM
150	180	15		19557	W	A	S	NBR
150	180	15		20454	W	A		FKM
150	180	15		18428	W	A		NBR
150	180	15		19667	W	B		NBR
150	180	15		130857	W	A		FKM
150	180	15		18429	W	C		NBR
150	180	15		27382	W	B	S	NBR
150	180	15		19668	W	C	S	NBR



油封

尺寸



油封

尺寸





















d1	d2	H	H2	产品编码	产品组	设计型号	形式	材质
150	180	15		173391	W	A		FKM
150	180	18		73247	W	A	S	NBR
150	190	13		49614	W	B	S	NBR
150	190	15		40077	W	A	S	NBR
150	190	15		19669	W	C		NBR
150	190	15		158280	W	A	S	FKM
150	190	15		27690	W	B	S	NBR
150	190	15		132876	W	A		NBR
150	190	16		18430	W	B		NBR
150	195	15		48778	W	C		NBR
150	200	15		40459	W	C		NBR
150	200	15		39999	W	A		NBR
150	225	15		179898	W	A		FKM
150.81	177.8	12.7		27291	W	A		NBR
152	190	15		83491	W	C		NBR
152	195	15		38542	W	C		NBR
152.4	171.45	11.9		43095	W	B	S	NBR
152.4	177.8	12.7		20212	W	A		NBR
152.4	177.8	12.7		60009	W	A	S	NBR
152.4	177.8	15.87		163727	W	C		NBR
152.4	180.98	15.87		60883	W	C		NBR
152.4	182.56	19.05		38540	W	C		NBR
152.4	184.15	15.87		43970	W	A		NBR
152.4	187.32	19		48692	W	A	S	FKM
152.4	187.32	19.05		83452	W	A	S	NBR
152.4	190.5	12.7		60010	W	A	S	NBR
152.4	190.5	19.05		24218	W	A		NBR
152.4	190.5	24.13		59733	W	A		NBR
152.4	190.7	15		38541	W	C		NBR
154	180	18		55875	W	A	S	NBR
155	172	14		40187	W	B	S	NBR
155	174	12		60232	W	A		FKM
155	174	12		40078	W	A		NBR
155	175	12		54384	W	A		NBR
155	175	12		48693	W	A		FKM
155	175	13		41325	W	A	S	NBR
155	177	12		57144	W	A		FKM
155	180	12		18431	W	C		NBR
155	180	12		134451	W	A		FKM
155	180	13		37105	W	A		FKM
155	180	14		57697	W	A		NBR
155	180	14		40188	W	B	S	NBR
155	180	15		44264	W	A		NBR
155	180	15		178350	W	A	S	FKM
155	180	15		18432	W	C		NBR
155	180	15		63551	W	A		FKM
155	180	15		56024	W	B	S	NBR
155	180	15		19558	W	A	S	NBR
155	180	17		40189	W	B	S	NBR
155	185	14		40190	W	B	S	NBR
155	185	15		41326	W	A	S	NBR
155	185	15		153802	W	B		FKM
155	185	15		57138	W	A	S	FKM
155	190	13		166643	W	A	S	NBR
155	190	15		40191	W	B		NBR



油封

尺寸

d1	d2	H	H2	产品编码	产品组	设计型号	形式	材质	
155	190	15		26426	W	A		NBR	
155	190	15		37024	W	C		NBR	
155	190	15		40079	W	A	S	NBR	
155	190	15		69911	W	A	S	FKM	
155	190	17		40192	W	B	S	NBR	
155	193.9	15.5		48779	W	C		NBR	
155	200	15		48780	W	C		NBR	
155	200	15		34923	W	A	S	NBR	
155	200	15		44265	W	A		NBR	
155	210	25		41319	W	A	S	NBR	
155.58	180.98	12.7		60011	W	A	S	NBR	
155.58	180.98	12.7		21024	W	A		NBR	
155.58	193.68	15.87		35848	W	A		NBR	
156	196	20		41402	W	A		NBR	
157	181	11.5		43094	W	C		NBR	
157	186.5	14.6		43093	W	C		NBR	
157	190.5	16		83492	W	C		NBR	
157.1	190.55	6.35		60233	W	C		NBR	
157.16	184.15	12.7		35606	W	A		NBR	
158	180	15		174321	W	C		FKM	
158	180	15		40460	W	C		NBR	
158	180	15		63552	W	A		FKM	
158	180	15		18433	W	A		NBR	
158	188	16		121507	W	B		NBR	
158	190	15		41403	W	A		NBR	
158.75	177.8	9.52		20232	W	A	S	NBR	
158.75	182.44	15.87		38209	W	A		NBR	
158.75	182.56	15.87		38214	W	A		NBR	
190.5	215.9	15.87		179843	W	A	Y	FKM	
158.75	184.15	12.7		60012	W	A	S	NBR	
158.75	184.15	12.7		38098	W	A		FKM	
158.75	184.15	12.7		21525	W	A		NBR	
158.75	190.5	12.7		83494	W	C		NBR	
158.75	190.5	15.87		36880	W	B	S	NBR	
158.75	196.85	15.87		83495	W	C		NBR	
158.8	190	12		83493	W	C		NBR	
159	185	16		48781	W	C		NBR	
160	180	10		68274	W	A		NBR	
160	180	10		41327	W	A	S	NBR	
160	180	10		74107	W	B	S	NBR	
160	180	10		35328	W	B		NBR	
160	180	10		48695	W	A	S	FKM	
160	180	12		44245	W	A		NBR	
160	180	12		118032	W	A		FKM	
160	180	13		40080	W	A	S	NBR	
160	180	15		40193	W	B	S	NBR	
160	180	15		19637	W	C		NBR	
160	180	15		56237	W	C	S	NBR	
160	180	15		38757	W	A		NBR	
160	185	8.5		118712	W	A	SY	NBR	
160	185	10		18434	W	A		NBR	
160	185	10		18673	W	B		NBR	
160	185	10		38701	W	C		NBR	
160	185	10		40081	W	A	S	NBR	
160	185	10		56868	W	A		FKM	



油封

尺寸





















d1	d2	H	H2	产品编码	产品组	设计型号	形式	材质
160	185	10		151602	W	A	S	FKM
160	185	13		39252	W	A	S	NBR
160	185	13		18435	W	B	S	NBR
160	185	15		18436	W	A		NBR
160	185	15		63555	W	A		FKM
160	190	8		48696	W	A	SY	FKM
160	190	8		157317	W	A	SY	NBR
160	190	13		19670	W	B		NBR
160	190	13		18437	W	A		NBR
160	190	13		19638	W	C		NBR
160	190	13		176411	W	A		FKM
160	190	13		40082	W	A	S	NBR
160	190	13		56517	W	B	S	NBR
160	190	13		63556	W	A		FKM
160	190	13		178351	W	A	S	FKM
160	190	14		65717	W	A		NBR
160	190	15		18438	W	A		NBR
160	190	15		19763	W	C	S	NBR
160	190	15		20455	W	A		FKM
160	190	15		25697	W	A	S	FKM
160	190	15		172686	W	A		FKM
160	190	15		19559	W	A	S	NBR
160	190	15		19762	W	B		NBR
160	190	15		19639	W	C		NBR
160	190	15		130984	W	A	S	FKM
160	190	15		130770	W	A		FKM
160	190	16		179429	W	A		NBR
160	190	16		133016	W	A	S	NBR
160	192	12		41329	W	A	S	NBR
160	195	15		41328	W	A	S	NBR
160	195	18		40083	W	A		NBR
160	200	10		157224	W	A	SY	FKM
160	200	10		157283	W	A	SY	NBR
160	200	12		64648	W	A		NBR
160	200	12		63557	W	A		FKM
160	200	12		18439	W	A		NBR
160	200	12		40084	W	A	S	NBR
160	200	14		48783	W	C		NBR
160	200	14		43096	W	B	S	NBR
160	200	14		19560	W	A		NBR
160	200	15		18440	W	A		NBR
160	200	15		44527	W	A	S	NBR
160	200	15		63558	W	A		FKM
160	200	15		38700	W	C		NBR
160	200	15		18441	W	B		NBR
160	210	20		41320	W	A	S	NBR
160	220	15		179758	W	A	S	NBR
160	240	14		176114	W	C		NBR
160.33	187.32	12.7		48782	W	C		NBR
161	215	15		69747	W	A		NBR
161.92	187.32	12.7		44455	W	A	S	NBR
161.92	187.32	12.7		27575	W	A		NBR
161.92	187.32	19.05		35849	W	A		NBR
161.92	190.5	12.7		35054	W	A		NBR
162	190	10		92870	W	C		NBR

Any seal. Any time.

www.dichtomatik.de



d1	d2	H	H2	产品编码	产品组	设计型号	形式	材质	
162	190	12		20501	W	A		FKM	
162	190	12		36373	W	A		NBR	
162	190	15		40461	W	C		NBR	
162	190	15		148905	W	A	S	FKM	
164.5	190	13		92193	W	A		FKM	
165	190	8		54467	W	A	S	NBR	
165	190	8		144474	W	A		FKM	
165	190	13		18442	W	A		NBR	
165	190	13		36817	W	B	S	NBR	
165	190	13		18443	W	C		NBR	
165	190	13		27383	W	C	S	NBR	
165	190	13		22611	W	A		FKM	
165	190	13		64937	W	B	S	NBR	
165	190	13		36847	W	A	S	NBR	
165	190	15		38620	W	C	S	NBR	
165	190	15		34889	W	C		NBR	
165	190	15		19562	W	A	S	NBR	
165	191	15		41400	W	A		NBR	
165	195	13		41404	W	A		NBR	
165	195	15		41331	W	A	S	NBR	
165	195	16		41330	W	A	S	NBR	
165	200	9		127301	W	A		NBR	
165	200	15		26382	W	A		NBR	
165	200	15		18700	W	A	S	NBR	
165	200	15		38699	W	C		NBR	
165	200	15		64840	W	A		FKM	
165.1	190.5	12.7		60013	W	A	S	NBR	
165.1	190.5	12.7		20213	W	A		NBR	
165.1	190.5	14.28		92871	W	C		NBR	
165.1	190.5	14.28		80401	W	A		FKM	
165.1	196.85	12.7		77866	W	C		NBR	
165.1	196.85	12.7		20859	W	A		NBR	
165.1	234.95	19.05		92932	W	C	S	NBR	
168	190	15		130568	W	A		FKM	
168	190	15		40462	W	C		NBR	
168	200	12		92872	W	C		NBR	
168	200	13		149618	W	A	S	FKM	
168	200	15		38698	W	C		NBR	
168.28	190.5	14.28		38210	W	A		NBR	
168.28	193.67	12.7		25984	W	A		NBR	
168.28	206.38	15.87		60884	W	C		NBR	
168.28	206.38	15.87		167186	W	C	S	NBR	
169	190	10		38543	W	C		NBR	
169.86	196.85	12.7		36629	W	A		NBR	
170	190	12		118033	W	A		FKM	
170	190	13		25675	W	A		NBR	
170	190	13		40085	W	A	S	NBR	
170	190	15		20486	W	A		FKM	
170	190	15		81160	W	A		NBR	
170	190	15		18444	W	C		NBR	
170	190	15		161985	W	B	S	NBR	
170	192	12		57145	W	A		FKM	
170	195	18		43097	W	B	S	NBR	
170	200	12		20456	W	A		FKM	
170	200	12		130994	W	A	S	NBR	

油封

尺寸





















油封

尺寸



d1	d2	H	H2	产品编码	产品组	设计型号	形式	材质
170	200	12		18445	W	A		NBR
170	200	12		157284	W	A	SY	NBR
170	200	13		149619	W	A	S	FKM
170	200	13		49444	W	A		FKM
170	200	13		19630	W	C		NBR
170	200	13		76592	W	C	S	NBR
170	200	14		72647	W	A		NBR
170	200	14		157285	W	A	SY	NBR
170	200	14		157225	W	A	SY	FKM
170	200	15		18446	W	A		NBR
170	200	15		18447	W	C		NBR
170	200	15		23728	W	B		NBR
170	200	15		20457	W	A		FKM
170	200	15		123128	W	C	S	NBR
170	200	15		19563	W	A	S	NBR
170	200	15		40194	W	B	S	NBR
170	200	15		27300	W	A	S	FKM
170	200	15		115176	W	A	SY	NBR
170	200	16		131746	W	A	SY	NBR
170	200	16		40086	W	A	S	NBR
170	200	16		10831	W	A		NBR
170	200	16		153808	W	B	S	NBR
170	200	16		48784	W	C	S	NBR
170	204	10		72495	W	A	S	FKM
170	205	15		40088	W	A	S	NBR
170	205	16		41332	W	A	S	NBR
170	205	17		175610	W	A	S	NBR
170	210	14		60653	W	A		NBR
170	210	15		41333	W	A	S	NBR
170	210	15		18448	W	B		NBR
170	210	20		40463	W	C		NBR
170	215	16		22248	W	C		NBR
170	220	15		40087	W	A		NBR
170	225	16		92873	W	C		NBR
170	225	20		41321	W	A	S	NBR
170	225	23		41322	W	A	S	NBR
170	245	16		48785	W	C		NBR
171.4	209.5	15.8		48787	W	C		NBR
171.45	196.85	12.7		60014	W	A	S	NBR
171.45	196.85	12.7		20216	W	A		NBR
171.45	196.85	19.05		60740	W	B	S	NBR
171.45	203.2	15.87		60885	W	C		NBR
172	190	8.5		157226	W	A	SY	FKM
172	200	15		40464	W	C		NBR
173	197	8		175300	W	A		FKM
173	200.3	15.87		43098	W	C		NBR
174	191	9		156245	W	A	S	FKM
174	230	22.5		41324	W	A	S	NBR
175	191	12		41323	W	A	S	NBR
175	195	13		68277	W	A		NBR
175	200	10		83189	W	A		FKM
175	200	10		176343	W	A		FKM
175	200	10		54700	W	A		NBR
175	200	12		134452	W	A		FKM
175	200	12		134456	W	A	S	FKM



d1	d2	H	H2	产品编码	产品组	设计型号	形式	材质	
175	200	15		18449	W	A		NBR	
175	200	15		18450	W	C		NBR	
175	200	15		27474	W	A		FKM	
175	205	15		127896	W	A		FKM	
175	205	15		159467	W	A		NBR	
175	205	15		166196	W	A	S	FKM	
175	205	15		21917	W	A		NBR	
175	205	15		59784	W	B		FKM	
175	210	14		21579	W	A		NBR	
175	210	14		22612	W	A		FKM	
175	210	15		92930	W	C	S	NBR	
175	210	15		92874	W	C		NBR	
175	210	15		151764	W	A		FKM	
175	215	16		19640	W	C		NBR	
175	220	17		43936	W	A		NBR	
175	250	16		43938	W	A		NBR	
176	213	19		173335	W	A	S	FKM	
176	214	12		41414	W	A	O	NBR	
176.2	203.2	12.7		25982	W	A		NBR	
177	250	16		43937	W	A		NBR	
177.8	203.2	12.7		60614	W	B		NBR	
177.8	203.2	12.7		20215	W	A		NBR	
177.8	203.2	12.7		60015	W	A	S	NBR	
177.8	203.2	12.7		69474	W	A		FKM	
177.8	203.2	15.88		48788	W	C		NBR	
177.8	203.2	19.05		60016	W	A	S	NBR	
177.8	206.38	10.15		48704	W	A		FKM	
177.8	215.9	12.7		39241	W	A		NBR	
177.8	215.9	12.7		27292	W	A	S	NBR	
177.8	215.9	12.7		159372	W	A		NBR	
177.8	215.9	19.05		20932	W	A	S	NBR	
177.8	215.9	19.05		60615	W	B		NBR	
177.8	222.25	9.52		148712	W	A		FKM	
177.8	222.25	19.05		48789	W	C		NBR	
178	200	12		92875	W	C		NBR	
178	200	15		40465	W	C		NBR	
178	208	15		18451	W	A		NBR	
178	215	16		40583	W	C		NBR	
179.95	209.55	18.25		48790	W	C		NBR	
180	200	10		68276	W	A		NBR	
180	200	12		38957	W	C		FKM	
180	200	13		37453	W	B	S	NBR	
180	200	13		20487	W	A		FKM	
180	200	13		22360	W	A		NBR	
180	200	15		18452	W	B	S	NBR	
180	200	15		19641	W	C		NBR	
180	200	15		40089	W	A	S	NBR	
180	200	15		34838	W	A		NBR	
180	200	15		36182	W	A		FKM	
180	200	16		56500	W	A	S	NBR	
180	200	16		56869	W	A	S	FKM	
180	200	16		56709	W	B	S	NBR	
180	202	12		57146	W	A		FKM	
180	210	6		159355	W	A	O	FKM	
180	210	8.5		118713	W	A	SY	NBR	

油封

尺寸





















油封

尺寸



d1	d2	H	H2	产品编码	产品组	设计型号	形式	材质
180	210	10		57187	W	A		NBR
180	210	10		41335	W	A	S	NBR
180	210	13		171652	W	A		FKM
180	210	14		41334	W	A	S	NBR
180	210	15		24676	W	A	S	FKM
180	210	15		18453	W	A		NBR
180	210	15		162050	W	A	S	NBR
180	210	15		19642	W	C		NBR
180	210	15		158188	W	A		NBR
180	210	15		22613	W	A		FKM
180	210	15		19564	W	A	S	NBR
180	210	15		26428	W	B		NBR
180	210	15		175308	W	A	S	FKM
180	210	16		41336	W	A	S	NBR
180	210	16		40354	W	B	S	NBR
180	215	15		37099	W	C		NBR
180	215	15		20488	W	A		FKM
180	215	15		41337	W	A	S	NBR
180	215	15		38621	W	C	S	NBR
180	215	16		19565	W	A	S	NBR
180	215	16		27686	W	B		NBR
180	215	16		22614	W	A		FKM
180	215	16		22254	W	A		NBR
180	215	16		160551	W	A		NBR
180	215	16		19610	W	C		NBR
180	220	13		40090	W	A	S	NBR
180	220	15		19870	W	A		NBR
180	220	15		24749	W	A		FKM
180	220	15		130753	W	A		FKM
180	220	15		40091	W	A	S	NBR
180	220	15		48792	W	C	S	NBR
180	220	15		160858	W	A	S	NBR
180	220	16		22009	W	C		NBR
180	220	16		44269	W	A		NBR
180	250	15		60258	W	C		NBR
180	250	15		179974	W	A	S	NBR
180.97	206.38	15.87		92876	W	C		NBR
180.97	219.3	19.05		48791	W	C		NBR
184.15	215.9	15.87		39581	W	C		NBR
184.15	215.9	15.87		56546	W	C	S	NBR
184.15	222.25	14.28		25981	W	A		NBR
184.15	222.25	14.28		56870	W	A		FKM
184.15	222.25	14.28		92877	W	C		NBR
184.15	222.25	14.5		83431	W	A		NBR
184.15	222.25	15.87		60017	W	A	S	NBR
185	205	12		162481	W	A	S	FKM
185	210	10		73240	W	A		FKM
185	210	13		60259	W	A	S	FKM
185	210	13		40092	W	A	S	NBR
185	210	13		20489	W	A		FKM
185	210	13		22019	W	C		NBR
185	210	13		18455	W	A		NBR
185	210	13		176344	W	A		FKM
185	210	14		69910	W	A	S	FKM
185	210	15		40093	W	A	S	NBR



d1	d2	H	H2	产品编码	产品组	设计型号	形式	材质	
185	210	15		59785	W	B		FKM	
185	215	12		179989	W	A		FKM	
185	215	13		20231	W	B		NBR	
185	215	15		64800	W	A		NBR	
185	215	15		179810	W	A		FKM	
185	215	15		19644	W	C		NBR	
185	215	16		83432	W	A		NBR	
185	215	16		48705	W	A		FKM	
185	230	16		69918	W	B		NBR	
185	230	16		22010	W	C		NBR	
185	250	24		41339	W	A	S	NBR	
186	215.9	12		92224	W	C		NBR	
186	216	12		92878	W	C		NBR	
188	215	16		92879	W	C		NBR	
188	238	16		41338	W	A	S	NBR	
190	200	16		43099	W	B		NBR	
190	212	12		57140	W	A		FKM	
190	215	15		54725	W	A	S	NBR	
190	215	15		38544	W	C		NBR	
190	215	16		18456	W	C		NBR	
190	215	16		83453	W	A	S	NBR	
190	215	16		48707	W	A	S	FKM	
190	220	12		92933	W	C	S	NBR	
190	220	12		38546	W	C		NBR	
190	220	12		40094	W	A		NBR	
190	220	15		19612	W	C		NBR	
190	220	15		20490	W	A		FKM	
190	220	15		35106	W	B		NBR	
190	220	15		18457	W	A		NBR	
190	220	15		18458	W	A	S	NBR	
190	220	15		130859	W	A		FKM	
190	220	15		131070	W	A	S	FKM	
190	220	15		162592	W	A	SY	FKM	
190	220	15		134896	W	A	SY	NBR	
190	220	15		124590	W	A	S	FKM	
190	220	16		19613	W	C		NBR	
190	220	16		44266	W	A		NBR	
190	225	12		22255	W	A		NBR	
190	225	15		41340	W	A	S	NBR	
190	225	15		18459	W	A		NBR	
190	225	15		40355	W	B		NBR	
190	225	15		40466	W	C		NBR	
190	225	16		27682	W	A		NBR	
190	225	16		134226	W	A	SY	NBR	
190	225	16		170871	W	A		NBR	
190	225	16		71699	W	A		FKM	
190	225	16		56871	W	A	S	FKM	
190	225	16		38478	W	A	S	NBR	
190	230	15		40356	W	B		NBR	
190	230	15		74060	W	C	S	NBR	
190	230	15		72641	W	A		NBR	
190	230	15		43126	W	A	S	NBR	
190	230	16		19744	W	C		NBR	
190	230	16		48708	W	A	S	FKM	
190	230	16		81230	W	A	S	NBR	

油封

尺寸





















油封

尺寸



d1	d2	H	H2	产品编码	产品组	设计型号	形式	材质
190	240	15		40095	W	A	S	NBR
190	240	25		40096	W	A	S	NBR
190.5	215.9	15.75		92880	W	C		NBR
190.5	215.9	15.87		37229	W	C		FKM
190.5	215.9	15.87		60886	W	C		NBR
190.5	222.25	15		38547	W	C		NBR
190.5	228.6	14.28		27041	W	A		NBR
190.5	228.6	19.05		92881	W	C		NBR
192	210	10		75013	W	B		NBR
192	210	10		54887	W	A		NBR
193	223	15		163434	W	A		FKM
193.67	219.07	14.28		48794	W	C		NBR
193.68	231.77	14.28		26100	W	A		NBR
193.7	219.08	12.7		92882	W	C		NBR
194	222	12		92883	W	C		NBR
195	215	15		83373	W	A		NBR
195	220	16		75102	W	A		FKM
195	220	16		38548	W	C		NBR
195	220	16		75103	W	C		FKM
195	230	15		22011	W	C		NBR
195	230	15		174956	W	C		NBR
195	230	15		125391	W	A		NBR
195	230	16		22842	W	C		NBR
195	230	16		20227	W	A		NBR
195	230	17		22256	W	A		NBR
195	231	20		41342	W	A	S	NBR
195	235	15		43124	W	A	S	NBR
195	235	15		122009	W	A		NBR
195	235	16		41341	W	A	S	NBR
195	250	22		41343	W	A	S	NBR
195	255	20		41344	W	A	S	NBR
196.85	222.25	12.7		60616	W	B		NBR
196.85	234.95	12.7		60018	W	A	S	NBR
196.85	234.95	14.28		48795	W	C		NBR
196.85	241.3	19.05		48796	W	C		NBR
198	230	12		41405	W	A		NBR
198	230	15		43125	W	A	S	NBR
200	222	12		57147	W	A		FKM
200	225	12		69751	W	C		NBR
200	225	12.5		38549	W	C		NBR
200	225	15		56872	W	A		FKM
200	225	15		18461	W	A		NBR
200	230	13		118714	W	A	SY	NBR
200	230	13		20491	W	A		FKM
200	230	13		38456	W	A		NBR
200	230	13		124928	W	A	SY	FKM
200	230	15		20492	W	A		FKM
200	230	15		18462	W	A		NBR
200	230	15		18463	W	C		NBR
200	230	15		37605	W	A	S	NBR
200	230	15		40357	W	B	S	NBR
200	230	15		35105	W	B		NBR
200	230	15		20757	W	C	S	NBR
200	230	15		27506	W	A	S	FKM
200	230	15		134891	W	A	SY	NBR



d1	d2	H	H2	产品编码	产品组	设计型号	形式	材质	
200	230	15		172685	W	A	S	NBR	
200	230	16		41345	W	A	S	NBR	
200	230	16		43927	W	C		NBR	
200	230	16		44267	W	A		NBR	
200	230	18		92934	W	C	S	NBR	
200	235	16		56694	W	A		NBR	
200	235	18		41346	W	A	S	NBR	
200	235	18		37650	W	A		NBR	
200	235	18		151763	W	A		FKM	
200	240	15		63209	W	A		NBR	
200	240	15		60263	W	B		NBR	
200	240	15		92925	W	C	S	NBR	
200	240	15		92884	W	C		NBR	
200	240	16		57139	W	A	S	FKM	
200	240	16		57320	W	C		NBR	
200	240	18		76111	W	A	S	NBR	
200	240	20		160662	W	A	S	FKM	
200	240	20		41347	W	A	S	NBR	
200	240	20		48797	W	C	S	NBR	
200	245	15		20672	W	C		NBR	
200	250	15		25906	W	A		NBR	
200	250	15		20493	W	A		FKM	
200	250	15		19614	W	C		NBR	
200	250	15		60264	W	B		FKM	
200	250	16		43939	W	C		NBR	
200	255	22		41283	W	A	S	NBR	
200	310	18		133670	W	A	S	NBR	
200	310	18		153719	W	A		NBR	
200.03	241.3	19.05		60887	W	C		NBR	
203	230	12		92926	W	C	S	NBR	
203	230	14		38550	W	C		NBR	
203.2	228.6	15.87		39582	W	C		NBR	
203.2	241.3	14.28		25983	W	A		NBR	
203.2	241.3	19.05		92885	W	C		NBR	
203.2	241.3	19.05		20931	W	A	S	NBR	
203.2	254	15.87		92927	W	C	S	NBR	
204.8	236	15		152146	W	C		NBR	
205	230	15		44852	W	B		NBR	
205	230	15		34839	W	A		NBR	
205	230	15		38551	W	C		NBR	
205	230	16		56873	W	A		FKM	
205	230	16		22012	W	C		NBR	
205	230	16		22259	W	A		NBR	
205	250	16		22013	W	C		NBR	
205	250	16		60265	W	A		NBR	
205	250	16		44582	W	C		FKM	
207	240	16		83454	W	A	S	NBR	
207	240	16		48709	W	A	S	FKM	
209.55	241.3	15.87		60888	W	C		NBR	
209.55	247.65	14.28		25980	W	A		NBR	
209.55	249.8	15.08		92887	W	C		NBR	
209.55	270.23	19.05		61825	W	C	S	NBR	
209.6	235	12.7		92886	W	C		NBR	
210	230	16		92888	W	C		NBR	
210	232	12		57148	W	A		FKM	

油封

尺寸





















油封

尺寸



d1	d2	H	H2	产品编码	产品组	设计型号	形式	材质
210	235	12		38552	W	C		NBR
210	236	12		41415	W	A	O	NBR
210	240	15		18464	W	C		NBR
210	240	15		43123	W	A	S	NBR
210	240	15		22615	W	A		FKM
210	240	15		135056	W	C		FKM
210	240	15		143883	W	A	S	FKM
210	240	15		19566	W	A		NBR
210	240	15		63078	W	C	S	NBR
210	240	15		175424	W	A		NBR
210	240	16		69563	W	C		FKM
210	240	16		38553	W	C		NBR
210	250	13		40467	W	C		NBR
210	250	15		56874	W	A		FKM
210	250	15		92928	W	C	S	NBR
210	250	15		19569	W	A	S	NBR
210	250	15		18465	W	A		NBR
210	250	15		44607	W	C		NBR
210	250	16		41406	W	A		NBR
210	250	16		19615	W	C		NBR
210	250	20		48798	W	C	S	NBR
210	260	15		38554	W	C		NBR
210	260	25		48799	W	C		NBR
210	265	18		41284	W	A	S	NBR
210	265	25		41407	W	A		NBR
210	275	26		41285	W	A	S	NBR
210	290	20		56876	W	A	S	FKM
210	290	20		56875	W	A		FKM
210	290	20		83433	W	A		NBR
210	290	20		83455	W	A	S	NBR
212	245	16		57305	W	B		NBR
212	245	16		57290	W	A		NBR
212	250	15		43100	W	C		NBR
212.72	247.65	19.05		37682	W	C		NBR
212.72	250.82	14.28		48801	W	C		NBR
214	241.5	15		34389	W	C		NBR
215	240	12		65053	W	A		FKM
215	240	12		48804	W	C		NBR
215	240	12		18690	W	A		NBR
215	240	15		36247	W	A		NBR
215	245	15		43122	W	A	S	NBR
215	245	16		92890	W	C		NBR
215	250	15		38555	W	C		NBR
215	250	16		161104	W	A		FKM
215	250	16		27683	W	A		NBR
215	250	16		92892	W	C		NBR
215	275	26		41286	W	A	S	NBR
215.9	241.3	12.7		92889	W	C		NBR
215.9	241.3	15.87		60889	W	C		NBR
215.9	247.65	19.05		36484	W	B		NBR
215.9	247.65	19.05		92891	W	C		NBR
215.9	254	14.28		27440	W	A		NBR
215.9	254	14.28		34875	W	C		NBR
215.9	254	19.05		35734	W	A	S	NBR
215.9	254	19.05		78494	W	A		NBR



d1	d2	H	H2	产品编码	产品组	设计型号	形式	材质	
216	260	16		152168	W	C		NBR	
218	250	16		40468	W	C		NBR	
219.1	244.5	12.7		92893	W	C		NBR	
220	245	8		40098	W	A		NBR	
220	250	11		19745	W	B		NBR	
220	250	12		60326	W	A		FKM	
220	250	12		83434	W	A		NBR	
220	250	14		130993	W	A	S	NBR	
220	250	14		55973	W	A		NBR	
220	250	15		40469	W	C	S	NBR	
220	250	15		157847	W	C		NBR	
220	250	15		130796	W	A		FKM	
220	250	15		19616	W	C		NBR	
220	250	15		40358	W	B		NBR	
220	250	15		134892	W	A	SY	NBR	
220	250	15		48710	W	A	S	FKM	
220	250	15		20494	W	A		FKM	
220	250	15		18466	W	A		NBR	
220	250	15		40097	W	A	S	NBR	
220	250	16		43101	W	C	S	NBR	
220	250	16		38758	W	A		NBR	
220	250	18		48805	W	C	S	NBR	
220	250	20		175611	W	A	S	NBR	
220	255	16		37649	W	A		NBR	
220	255	16		48711	W	A		FKM	
220	255	18		10861	W	A		NBR	
220	260	14		41287	W	A	S	NBR	
220	260	15		72596	W	A		FKM	
220	260	15		60268	W	A		NBR	
220	260	15		40561	W	C		NBR	
220	260	16		38457	W	A		NBR	
220	260	16		35961	W	B		FKM	
220	260	16		36230	W	A		FKM	
220	260	18		92894	W	C		NBR	
220	260	22		48806	W	C	S	NBR	
220	260	22		44749	W	A		NBR	
220	260	22		92895	W	C		NBR	
220	270	15		20889	W	C		NBR	
220	275	23		43121	W	A	S	NBR	
220	300	15		148918	W	C		NBR	
225	250	12.5		48808	W	C		NBR	
225	250	15		40099	W	A		NBR	
225	250	16		22014	W	C		NBR	
225	260	15		41288	W	A	S	NBR	
225	260	15		69913	W	C		NBR	
225	270	16		69919	W	B		NBR	
225	270	16		40470	W	C		NBR	
225	315	25		43102	W	B		NBR	
225.43	257.18	19.05		36485	W	B		NBR	
225.43	257.18	19.05		92896	W	C		NBR	
228.6	254	11.11		59734	W	A		NBR	
228.6	254	19.05		38556	W	C		NBR	
228.6	266.7	14.28		37594	W	A		NBR	
229	255	15		38557	W	C		NBR	
230	250	8		156331	W	A	O	NBR	

油封

尺寸





















油封

尺寸



d1	d2	H	H2	产品编码	产品组	设计型号	形式	材质
230	250	15		43956	W	A		NBR
230	250	20		92929	W	C	S	NBR
230	255	10		40359	W	B		NBR
230	255	10		19645	W	C		NBR
230	255	10		161620	W	A		NBR
230	255	15		36793	W	C		NBR
230	255	15		27684	W	A		NBR
230	260	15		19567	W	A		NBR
230	260	15		19646	W	C		NBR
230	260	15		38479	W	A	S	NBR
230	260	15		20495	W	A		FKM
230	260	15		22549	W	A	S	FKM
230	260	15		18467	W	B		NBR
230	260	20		43114	W	A	S	NBR
230	269	22		44750	W	A		NBR
230	270	15		19617	W	C		NBR
230	270	15		158516	W	C		NBR
230	270	15		44742	W	A	S	NBR
230	270	15		72642	W	A		NBR
230	270	16		69544	W	C		NBR
230	270	16		62329	W	C	S	NBR
230	270	22		43113	W	A	S	NBR
230	280	15		18468	W	A		NBR
230	280	15		22616	W	A		FKM
230	280	16		22015	W	C		NBR
230	280	16		130175	W	A		FKM
230	280	16		40646	W	A		NBR
230	285	23		92897	W	C		NBR
230	285	23		38390	W	A	S	NBR
230	285	23		38391	W	B	S	NBR
234.95	266.7	15.87		37031	W	A		FKM
234.95	273.05	15.87		60019	W	A	S	NBR
234.95	273.05	15.88		48809	W	C		NBR
235	270	15		92898	W	C		NBR
235	270	16		69920	W	B		NBR
235	270	16		49607	W	C		FKM
235	270	16		19618	W	C		NBR
240	265	15		41289	W	A	S	NBR
240	270	8.5		157228	W	A	SY	FKM
240	270	8.5		118715	W	A	SY	NBR
240	270	14		43120	W	A	S	NBR
240	270	15		48712	W	A	S	FKM
240	270	15		21078	W	C	S	NBR
240	270	15		20230	W	A		NBR
240	270	15		19619	W	C		NBR
240	270	15		171687	W	A		FKM
240	270	15		134893	W	A	SY	NBR
240	270	15		40100	W	A	S	NBR
240	270	15		27687	W	B		NBR
240	270	15		20496	W	A		FKM
240	270	16		35383	W	C		NBR
240	273	16		41290	W	A	S	NBR
240	275	16		71700	W	A		FKM
240	275	16		83435	W	A		NBR
240	275	18		90482	W	B		NBR



d1	d2	H	H2	产品编码	产品组	设计型号	形式	材质	
240	275	18		20655	W	C		NBR	
240	275	18		10876	W	A		NBR	
240	280	14		20912	W	B		NBR	
240	280	15		56877	W	A		FKM	
240	280	15		18469	W	A		NBR	
240	280	16		18470	W	C		NBR	
240	280	16		76105	W	A		NBR	
240	280	16		69921	W	B		NBR	
240	280	16		62330	W	C	S	NBR	
240	280	19		44751	W	A		NBR	
240	280	20		34393	W	C	S	NBR	
240	290	16		22016	W	C		NBR	
240	300	18		21118	W	C		NBR	
240	335	15		126466	W	A		NBR	
241.3	279.4	19.05		39573	W	B		NBR	
241.3	279.4	19.05		75062	W	C		NBR	
241.3	280	30		39572	W	C		NBR	
241.3	292.1	25.4		60273	W	C		NBR	
241.3	304.8	25.4		41416	W	A	O	NBR	
241.3	317.5	20.64		60920	W	C	S	NBR	
241.3	317.7	20.6		92899	W	C		NBR	
245	270	16		40360	W	B		NBR	
245	270	16		19620	W	C		NBR	
245	273	15		158771	W	A	S	NBR	
245	285	16.5		48811	W	C		NBR	
247	348	13		155733	W	A		FKM	
247.65	279.4	15.87		48812	W	C		NBR	
247.65	279.4	19.05		79107	W	A	S	NBR	
247.65	282.58	19.05		40900	W	B		NBR	
247.65	282.58	19.05		92900	W	C		NBR	
250	280	14		44608	W	C		NBR	
250	280	15		46812	W	A	S	NBR	
250	280	15		38622	W	C	S	NBR	
250	280	15		26429	W	B		NBR	
250	280	15		19621	W	C		NBR	
250	280	15		18471	W	A		NBR	
250	280	15		20497	W	A		FKM	
250	280	16		41291	W	A	S	NBR	
250	280	16		26371	W	C		NBR	
250	280	16		19568	W	A		NBR	
250	285	18		20656	W	C		NBR	
250	285	18		69922	W	B		NBR	
250	290	15		34689	W	A		NBR	
250	290	15		48813	W	C		NBR	
250	290	16		69923	W	B		NBR	
250	290	16		134769	W	A		FKM	
250	290	16		43104	W	C	S	NBR	
250	290	16		19622	W	C		NBR	
250	290	16		10846	W	A		NBR	
250	310	25		39225	W	C		NBR	
254	279.4	12.7		92901	W	C		NBR	
254	292.1	14.28		60020	W	A	S	NBR	
254	292.1	14.28		37593	W	A		NBR	
254	292.1	19.05		60890	W	C		NBR	
254	304.8	15.87		75279	W	C		NBR	

油封

尺寸



油封

尺寸





















d1	d2	H	H2	产品编码	产品组	设计型号	形式	材质
255	290	16		48814	W	C		NBR
255	290	16		118680	W	A		FKM
255	315	25		43105	W	B		NBR
258	290	16		60283	W	C		NBR
259	281	11		171046	W	A	S	NBR
260	280	10		118716	W	A	SY	NBR
260	280	10		157229	W	A	SY	FKM
260	280	16		20233	W	C		NBR
260	280	16		149406	W	C	S	NBR
260	290	15		55199	W	A		NBR
260	290	15		48713	W	A		FKM
260	290	15		130995	W	A	S	NBR
260	290	16		92923	W	C	S	NBR
260	290	16		179467	W	A	S	FKM
260	290	16		19623	W	C		NBR
260	290	16		18472	W	A		NBR
260	290	20		117338	W	A		FKM
260	290	20		48816	W	C		NBR
260	300	15		60276	W	B		NBR
260	300	15		72643	W	A		NBR
260	300	16		40562	W	C		NBR
260	300	16		75104	W	A		FKM
260	300	16		75105	W	C		FKM
260	300	18		20846	W	A	S	NBR
260	300	18		20010	W	A		NBR
260	300	18		43107	W	B		NBR
260	300	20		19648	W	C		NBR
260	300	20		75278	W	C	S	NBR
260	300	20		27688	W	B		NBR
260	300	20		59791	W	B	S	FKM
260	300	20		25806	W	A		NBR
260	300	20		22617	W	A		FKM
260	300	22		13291	W	B		NBR
260	310	16		74724	W	C		NBR
260	320	25		92902	W	C		NBR
260	320	25		48817	W	C	S	NBR
260	330	20		60277	W	C		NBR
263.53	295.28	22.22		75280	W	C		NBR
263.53	295.28	22.23		92903	W	C		NBR
263.53	295.28	22.23		40901	W	B		NBR
264	290	15		43106	W	C		NBR
265	290	15		69543	W	C		NBR
265	290	16		44090	W	A		FKM
265	290	16		19624	W	C		NBR
265	290	16		42609	W	A	S	FKM
265	290	16		38458	W	A		NBR
265	300	16		75277	W	C		NBR
265	310	16		38558	W	C		NBR
266.7	304.8	19.05		48818	W	C		NBR
266.7	304.8	19.05		39368	W	C	S	NBR
266.7	317.5	15.87		75281	W	C		NBR
266.7	317.5	25.4		59735	W	A		NBR
266.7	317.5	25.4		37839	W	C		FKM
266.7	317.5	25.4		56208	W	A		FKM
267	300	20		75282	W	C		NBR

Any seal. Any time.

www.dichtomatik.de



d1	d2	H	H2	产品编码	产品组	设计型号	形式	材质	
268	300	16		38559	W	C		NBR	
270	300	15		90276	W	A		NBR	
270	300	15		20794	W	B		NBR	
270	300	15		152978	W	A		FKM	
270	310	15		72644	W	A		NBR	
270	310	16		168823	W	A		NBR	
270	310	16		56652	W	C	S	NBR	
270	310	16		158021	W	B	S	FKM	
270	310	16		129934	W	A		FKM	
270	310	16		57081	W	A	S	NBR	
270	310	16		19625	W	C		NBR	
270	310	18		19873	W	C		NBR	
270	310	20		64572	W	A		NBR	
270	310	20		60278	W	B		FKM	
270	310	20		44752	W	A	S	NBR	
270	320	18		135147	W	A	S	NBR	
270	320	18		135146	W	A		NBR	
270	330	20		41293	W	A	S	NBR	
270	330	25		44753	W	A		NBR	
270	330	25		48819	W	C		NBR	
272	310	16		48820	W	C		NBR	
273.05	323.85	25.4		148709	W	A	S	FKM	
273.05	323.85	25.4		48821	W	C		NBR	
273.05	339.73	31.75		60921	W	C	S	NBR	
275	294	12		133752	W	B		NBR	
275	294	12		65051	W	A		NBR	
275	310	15		21954	W	C		NBR	
275	310	16		49545	W	C		FKM	
275	310	16		19626	W	C		NBR	
279.3	310	17		41292	W	A	S	NBR	
279.4	304.8	12.7		75283	W	C		NBR	
279.4	317.5	19.05		59571	W	C		NBR	
279.4	330	19.05		48823	W	C	S	NBR	
280	310	15		20498	W	A		FKM	
280	310	15		21348	W	A		NBR	
280	310	15		39356	W	A	S	NBR	
280	310	15		60280	W	C		NBR	
280	310	16		19627	W	C		NBR	
280	310	16		62331	W	C	S	NBR	
280	310	16		43116	W	A	S	NBR	
280	310	16		175848	W	C		NBR	
280	316	18		48824	W	C		NBR	
280	316	18		41408	W	A		NBR	
280	320	15		72645	W	A		NBR	
280	320	16		38623	W	C	S	NBR	
280	320	16		34410	W	C		NBR	
280	320	18		60282	W	C		NBR	
280	320	18		44754	W	A		NBR	
280	320	18		60281	W	B		NBR	
280	320	20		19649	W	C		NBR	
280	320	20		43115	W	A	S	NBR	
280	320	20		38624	W	C	S	NBR	
280	320	20		27689	W	B		NBR	
280	320	20		36946	W	A		FKM	
280	320	20		21580	W	A		NBR	

油封

尺寸



油封

尺寸





















d1	d2	H	H2	产品编码	产品组	设计型号	形式	材质
280	320	20		73241	W	A	S	FKM
280	324	25		26242	W	C		NBR
280	340	28		41294	W	A	S	NBR
280	340	28		44755	W	A		NBR
280	350	16		56878	W	A		FKM
280	380	20		48825	W	C		NBR
280	400	15		75284	W	C		NBR
285	310	16		22017	W	C		NBR
285	310	16		130474	W	A	S	NBR
285	320	16		38560	W	C		NBR
285	325	15		75285	W	C		NBR
285	325	16		48826	W	C		NBR
285	325	16		76586	W	A		NBR
285	330	20		48827	W	C		NBR
285.75	323.85	19.05		37322	W	C		NBR
285.75	336.55	23.81		92197	W	A		FKM
285.75	336.55	23.81		44120	W	A		NBR
287	330	18		75096	W	A		NBR
290	330	15		48828	W	C		NBR
290	330	16		56316	W	C		NBR
290	330	18		41295	W	A	S	NBR
290	330	18		19628	W	C		NBR
290	330	20		56906	W	A		FKM
290	330	20		69924	W	B		NBR
290	334	20		48829	W	C		NBR
290	350	25		48831	W	C		NBR
295	325	15		176724	W	A	S	NBR
295	335	16		38564	W	C		NBR
295	335	18		92904	W	C		NBR
298.45	336.55	22.22		36483	W	B		NBR
298.45	336.55	22.22		37640	W	C		NBR
300	320	20		27639	W	A		NBR
300	332	16		180991	W	A		NBR
300	332	16		19629	W	C		NBR
300	332	16		22844	W	C	S	NBR
300	332	16		179172	W	A	S	FKM
300	332	16		160052	W	A		FKM
300	335	18		19650	W	C		NBR
300	340	15		56792	W	A		NBR
300	340	16		56317	W	C		NBR
300	340	16		17150	W	A		NBR
300	340	18		18473	W	A		NBR
300	340	18		24094	W	A		FKM
300	340	18		68886	W	C		NBR
300	340	18		44123	W	A	S	NBR
300	340	20		35589	W	C	S	NBR
300	340	20		37281	W	B		FKM
300	340	20		18474	W	C		NBR
300	340	20		36073	W	A		FKM
300	340	20		120843	W	B	S	FKM
300	340	20		171245	W	A		NBR
300	340	20		171246	W	A	S	NBR
300	340	20		35553	W	A		NBR
300	340	20		158171	W	A		NBR
300	340	20		22028	W	A	S	NBR



油封

尺寸

d1	d2	H	H2	产品编码	产品组	设计型号	形式	材质	
300	342	16		34417	W	C		NBR	
300	344	20		35007	W	B		FKM	
300	344	20		35008	W	A		FKM	
300	344	20.5		48833	W	C		NBR	
300	350	18		44152	W	C		NBR	
300	350	19		42645	W	C		NBR	
300	350	20		92905	W	C		NBR	
300	350	25		44756	W	A		NBR	
300	360	18		38565	W	C		NBR	
300	400	18		92906	W	C		NBR	
300	420	20		92907	W	C		NBR	
301	328	15		43108	W	C		NBR	
304.8	330.2	12.7		48834	W	C		NBR	
304.8	355.6	25.4		48835	W	C		NBR	
305	330	13		83013	W	A		NBR	
305	335	17		41296	W	A	S	NBR	
305	340	18		38566	W	C		NBR	
305	345	20		56971	W	C		NBR	
305	349	20		161371	W	A	S	FKM	
310	340	15		83456	W	A	S	NBR	
310	340	15		48717	W	A	S	FKM	
310	340	16		41297	W	A	S	NBR	
310	350	18		38567	W	C		NBR	
310	350	18		72507	W	B		FKM	
310	350	18		82111	W	A		NBR	
310	350	18		149518	W	A		FKM	
310	350	20		44757	W	A	S	NBR	
310	355	20		163272	W	C		FKM	
310	355	20		163271	W	B		FKM	
310	370	25		44758	W	A		NBR	
310	370	28		36644	W	C		NBR	
315	350	18		42989	W	A		NBR	
315	350	18		168313	W	A		FKM	
315	355	16.5		48836	W	C		NBR	
315	355	18		44957	W	C		NBR	
315	355	18		40666	W	A		NBR	
315	359	20		61790	W	A		NBR	
315	365	16		69545	W	C		NBR	
315	365	20		37124	W	C		FKM	
315	365	20		37361	W	C		NBR	
317.5	349.25	19.05		38568	W	C		NBR	
317.5	349.25	19.5		92908	W	C		NBR	
317.5	355.6	11.2		163672	W	A	S	NBR	
320	350	15		124924	W	A		FKM	
320	350	15		43117	W	A	S	NBR	
320	350	16		40037	W	C		NBR	
320	350	18		18475	W	C		NBR	
320	360	15		20879	W	B		NBR	
320	360	15		92909	W	C		NBR	
320	360	18		43112	W	C	S	NBR	
320	360	18		20499	W	A		FKM	
320	360	18		41298	W	A	S	NBR	
320	360	18		42990	W	A		NBR	
320	360	18		19651	W	C		NBR	
320	360	20		48837	W	C	S	NBR	



油封

尺寸





















d1	d2	H	H2	产品编码	产品组	设计型号	形式	材质
320	360	20		178380	W	C		FKM
320	360	20		27394	W	A		FKM
320	360	20		20713	W	A	S	NBR
320	360	20		25673	W	A		NBR
320	360	20		20221	W	C		NBR
320	360	25		48838	W	C		NBR
320	360	32		48839	W	C		NBR
320	380	20		48840	W	C		NBR
320	380	25		59530	W	C		NBR
320	380	25		44759	W	A		NBR
320	380	28		69153	W	A		NBR
320	380	28		44760	W	A	S	NBR
320	410	28		41409	W	A		NBR
322	354.5	17		41299	W	A	S	NBR
323.85	346.07	14.28		179179	W	A	S	FKM
323.85	374.65	19.05		69925	W	B		NBR
325	360	16		59790	W	C		NBR
325	365	16		38569	W	C		NBR
325	365	16		122109	W	A		FKM
325	365	16		180184	W	A	S	NBR
330	360	15		92910	W	C		NBR
330	360	18		162296	W	C	S	NBR
330	370	18		23771	W	C		NBR
330	370	18		56449	W	C	S	NBR
330	370	18		24895	W	A		NBR
330	370	18		48718	W	A		FKM
330	370	20		69857	W	C		NBR
330	370	20		65301	W	B		FKM
330	380	20		21567	W	C		NBR
330	385	18		92911	W	C		NBR
330	390	25		69585	W	A		NBR
330.2	376.23	15.87		148710	W	A		FKM
330.2	381	23.79		21560	W	C		NBR
335	375	18		122603	W	A		FKM
335	375	25		69926	W	B		NBR
340	370	15		179158	W	A	S	NBR
340	372	16		150888	W	A		FKM
340	372	16		62332	W	C	S	NBR
340	372	16		19632	W	C		NBR
340	372	16		84441	W	B		NBR
340	380	15		158278	W	A	S	FKM
340	380	16		43110	W	B		NBR
340	380	16		38570	W	C		NBR
340	380	18		20887	W	A		NBR
340	380	18		19633	W	C		NBR
340	380	18		44619	W	A		FKM
340	380	20		19634	W	C		NBR
340	380	20		62333	W	C	S	NBR
340	380	20		165151	W	A		NBR
340	380	20		36509	W	A		NBR
340	380	20		134402	W	A		FKM
340	390	20		48841	W	C		NBR
340	390	25		57272	W	A		NBR
340	400	25		21658	W	C		NBR
342.9	368.3	12.7		38821	W	C	S	NBR

Any seal. Any time.

www.dichtomatik.de



d1	d2	H	H2	产品编码	产品组	设计型号	形式	材质	
342.9	388.93	15.87		148711	W	A		FKM	
349.25	381	19.05		56354	W	C		NBR	
350	380	16		60289	W	C		NBR	
350	380	17.5		158022	W	B	S	FKM	
350	390	18		56879	W	A		FKM	
350	390	18		38459	W	A		NBR	
350	390	18		48842	W	C	S	NBR	
350	390	18		38571	W	C		NBR	
350	390	20		48843	W	C	S	NBR	
350	390	20		76106	W	A		NBR	
350	400	12		39226	W	A	S	NBR	
350	410	28		41417	W	A		NBR	
355	395	32		34422	W	C		NBR	
355	405	15		34428	W	C		NBR	
355.6	396.87	19.05		59466	W	A		NBR	
360	390	15		48719	W	A	S	FKM	
360	390	15		83457	W	A	S	NBR	
360	390	18		56254	W	A		NBR	
360	390	20		48846	W	C		NBR	
360	392	20		48847	W	C		NBR	
360	392	20		48848	W	C	S	NBR	
360	400	16		76178	W	A		NBR	
360	400	18		78377	W	A		FKM	
360	400	18		44168	W	C		NBR	
360	400	18		56793	W	A		NBR	
360	400	20		74889	W	C	S	NBR	
360	400	20		74892	W	C		FKM	
360	400	20		19635	W	C		NBR	
360	400	20		44917	W	B		NBR	
360	400	20		48720	W	A	S	FKM	
360	400	20		35406	W	A		NBR	
360	400	20		180148	W	A		FKM	
360	400	25		59469	W	C		NBR	
360	425	20		48850	W	C		NBR	
361.95	400.05	19.05		38572	W	C		NBR	
361.95	412.75	25.4		38573	W	C		NBR	
365	395	15		48851	W	C		NBR	
365	405	18		38574	W	C		NBR	
365	410	20		38575	W	C		NBR	
365.12	412.75	17.46		57291	W	A		NBR	
366.72	406.4	17.46		59471	W	C		NBR	
370	400	10		38576	W	C		NBR	
370	410	15		20222	W	A		NBR	
370	410	15		35846	W	C		NBR	
370	410	20		48852	W	C		NBR	
370	410	20		22843	W	C	S	NBR	
370	415	15		48853	W	C		NBR	
374.65	419.1	18		152028	W	C		FKM	
375	420	18		36973	W	C		NBR	
375	430	18		48854	W	C		NBR	
380	410	12		36561	W	B		NBR	
380	420	15		37305	W	A		NBR	
380	420	18		24746	W	A		NBR	
380	420	18		38577	W	C		NBR	
380	420	20		57083	W	C		FKM	

油封

尺寸



油封

尺寸





















d1	d2	H	H2	产品编码	产品组	设计型号	形式	材质
380	420	20		19636	W	C		NBR
380	420	20		38461	W	A		NBR
380	420	20		159767	W	C		NBR
380	420	20		57082	W	B		FKM
380	420	20		26244	W	A		FKM
380	420	20		26239	W	A	S	NBR
380	424	20		40101	W	A		NBR
380	430	19		38578	W	C		NBR
380	430	19		62334	W	C	S	NBR
380	445	15		43111	W	C		NBR
381	425.45	19		43119	W	A	S	NBR
381	431.8	25.4		74447	W	C		NBR
381	438.15	22.22		44606	W	C		NBR
385	415	17		41302	W	A	S	NBR
390	425	18		92924	W	C	S	NBR
390	425	18		166541	W	A	S	FKM
390	430	18		38579	W	C		NBR
390	430	20		83436	W	A		NBR
390	430	20		37860	W	A	S	NBR
390	430	20		56882	W	A		FKM
390	435	18		48856	W	C	S	NBR
390	440	25		48857	W	C		NBR
390	440	25		41301	W	A	S	NBR
393.7	444.5	20.57		92912	W	C		NBR
394	420	16		104347	W	A	S	FKM
394	420	16		48858	W	C		NBR
394	420	16		56948	W	A	S	NBR
394	420	16		38462	W	A		NBR
395	430	15		38052	W	C		NBR
395	430	18		35443	W	C		NBR
395	432	20		43118	W	A	S	NBR
400	425	15		158023	W	B	S	FKM
400	425	15		69927	W	B		NBR
400	430	26		38820	W	C		NBR
400	438.5	17		37258	W	C		NBR
400	440	15		35984	W	C		NBR
400	440	15		167976	W	A	S	NBR
400	440	18		72649	W	C		NBR
400	440	18		76107	W	A		NBR
400	440	18		69928	W	B		NBR
400	440	20		69573	W	A		NBR
400	440	20		37477	W	C		NBR
400	440	20		56884	W	A		FKM
400	440	20		166549	W	C		NBR
400	440	20		60923	W	B		NBR
400	450	18		92913	W	C		NBR
400	450	20		27630	W	C		NBR
400	450	25		48721	W	A	SY	FKM
400	450	25		38580	W	C	S	NBR
400	450	25		83682	W	A		NBR
400	451	17.46		36559	W	C		NBR
400	470	20		48859	W	C		NBR
400	500	25		48860	W	C		NBR
410	440	15		163874	W	A	S	NBR
410	454	20.5		48862	W	C		NBR

Any seal. Any time.

www.dichtomatik.de



d1	d2	H	H2	产品编码	产品组	设计型号	形式	材质	
410	460	15		48864	W	C		NBR	
410	460	22		57217	W	A	S	NBR	
410	460	22		69631	W	C		NBR	
412.75	450.85	17.46		26906	W	C		NBR	
412.75	457.2	19.05		155760	W	C		NBR	
420	460	15		38581	W	C		NBR	
420	460	18		20714	W	C		NBR	
420	460	20		37895	W	A		FKM	
420	460	20		39233	W	A		NBR	
420	460	20		46484	W	C	S	NBR	
420	460	20		38582	W	C		NBR	
420	460	20		21315	W	B		NBR	
420	470	15		43648	W	A		NBR	
420	470	20		38460	W	A	S	NBR	
420	470	20		163067	W	A		NBR	
420	480	15		59333	W	C		NBR	
425	475	22		48866	W	C		NBR	
425	480	15		44605	W	C		NBR	
425.45	463.55	17.46		48865	W	C		NBR	
430	460	14		37996	W	A		NBR	
430	460	15		179157	W	A	S	NBR	
430	480	22		92914	W	C		NBR	
430	480	25		92915	W	C		NBR	
430	495	25		92916	W	C		NBR	
431.8	469.9	19.05		35590	W	C	S	NBR	
435	465	18		88201	W	B		NBR	
440	470	20		38583	W	C		NBR	
440	480	20		74550	W	B		NBR	
440	480	20		38589	W	C		NBR	
440	480	20		36709	W	A		NBR	
440	480	20		48723	W	A	S	FKM	
440	480	20		26245	W	A		FKM	
440	480	20		25049	W	A	S	NBR	
440	490	17		48868	W	C		NBR	
440	490	20		38590	W	C		NBR	
445	480	16		48869	W	C		NBR	
445	480	18		21868	W	C		NBR	
448	480	15		39362	W	C		NBR	
450	490	18		48870	W	C		NBR	
450	490	20		21194	W	C		NBR	
450	500	22		38463	W	A		NBR	
450	500	22		56886	W	A	S	FKM	
450	500	25		38591	W	C		NBR	
450	500	25		76108	W	A		NBR	
450	510	25		69556	W	A		NBR	
455	495	20		48871	W	C		NBR	
457	508	25.4		35847	W	C		NBR	
457.2	495.3	19.05		42643	W	C		NBR	
459	522	27		44980	W	C		NBR	
460	500	20		38592	W	C		NBR	
460	500	20		83721	W	A		NBR	
460	500	20		171288	W	B		FKM	
460	500	20		134401	W	A		FKM	
460	500	20		166548	W	C		NBR	
460	510	25		48872	W	C		NBR	

油封

尺寸



油封

尺寸





















d1	d2	H	H2	产品编码	产品组	设计型号	形式	材质
460	520	26		48873	W	C		NBR
461	500	20		20712	W	C		NBR
467	510	20		82378	W	A		NBR
467	510	20		24282	W	C		NBR
470	500	20		135295	W	A	S	FKM
470	510	20		20711	W	C		NBR
470	520	18		48874	W	C		NBR
470	520	20		48875	W	C		NBR
470	520	22		37259	W	C		NBR
470	520	25		69929	W	B		NBR
475	530	18		77774	W	C		NBR
480	520	20		69930	W	B		NBR
480	520	20		48876	W	C	S	NBR
480	520	20		48724	W	A	S	FKM
480	520	20		56887	W	A		FKM
480	520	20		38464	W	A		NBR
480	520	20		25412	W	A	S	NBR
480	520	20		74545	W	C		FKM
480	520	20		38593	W	C		NBR
480	530	22		157401	W	A	S	FKM
480	530	25		76110	W	A		NBR
480	530	25		20670	W	A	S	NBR
480	550	25		92917	W	C		NBR
482	530	20		117784	W	C		NBR
485	535	22		37586	W	C		NBR
485	535	22		37583	W	A		NBR
490	530	20		48878	W	C		NBR
490	530	20		163018	W	A		FKM
490	540	25		20709	W	A		NBR
500	520	12		41115	W	C		NBR
500	535	12		92918	W	C		NBR
500	540	18		176199	W	A	S	NBR
500	540	20		56888	W	A	S	FKM
500	540	20		38594	W	C		NBR
500	540	20		38465	W	A		NBR
500	540	20		56949	W	A	S	NBR
500	550	20		92919	W	C		NBR
500	550	22		37585	W	C		NBR
500	550	22		44881	W	A		FKM
500	550	22		37582	W	A		NBR
500	550	25		76109	W	A		NBR
500	560	20		38596	W	C		NBR
500.06	549.91	19.84		38595	W	C		NBR
508	558.8	25.4		49490	W	C		NBR
510	550	20		48880	W	C		NBR
510	572	20		38597	W	C		NBR
520	560	14		152084	W	C		NBR
520	580	20		48881	W	C		NBR
520	580	25		83598	W	B		NBR
520.7	571.5	22.5		21639	W	C		NBR
530	565	20		56899	W	C		NBR
530	570	20		38598	W	C		NBR
530	580	22		87130	W	C	S	NBR
533.4	584.2	22.22		37089	W	C		NBR
540	580	20		38599	W	C		NBR

Any seal. Any time.

www.dichtomatik.de



d1	d2	H	H2	产品编码	产品组	设计型号	形式	材质	
540	590	20		116745	W	A	S	FKM	
540	590	22		48883	W	C		NBR	
540	590	25.5		38600	W	C		NBR	
546	596.9	19.05		36521	W	A		NBR	
549.28	600.08	25.4		44334	W	C		NBR	
550	590	20		36560	W	C		NBR	
550	600	22		48884	W	C		NBR	
550	600	25		76014	W	A		NBR	
555	600	20		38601	W	C		NBR	
560	590	20		117548	W	A	S	FKM	
560	610	20		59536	W	C	S	FKM	
560	610	20		38602	W	C		NBR	
560	610	22		173475	W	A		NBR	
560	610	25		159452	W	A	S	FKM	
560	620	20		38603	W	C		NBR	
560	620	25		48885	W	C		NBR	
565	630	20		55919	W	C		NBR	
570	620	22		36643	W	C		NBR	
570	630	25		48886	W	C		NBR	
580	630	20		48888	W	C		NBR	
580	636	25		48889	W	C		NBR	
580	640	25		48890	W	C		NBR	
580	640	30		48892	W	C		NBR	
595	635	20		48893	W	C		NBR	
600	640	20		59499	W	A		FKM	
600	640	20		20671	W	A		NBR	
600	640	20		38604	W	C		NBR	
600	640	22		92935	W	C	S	NBR	
600	640	22		72903	W	C		NBR	
609.6	660.4	22.22		38605	W	C		NBR	
610	650	20		38606	W	C		NBR	
610	660	20		38607	W	C		NBR	
620	660	20		42664	W	C		NBR	
620	670	25		56286	W	C		NBR	
620	680	25		48898	W	C		NBR	
620	684	25		37581	W	A		NBR	
620	684	25		37584	W	C		NBR	
628	655	20		48899	W	C		NBR	
630	670	20		38608	W	C		NBR	
630	670	20		126775	W	B	S	FKM	
630	680	20		38609	W	C		NBR	
630	690	30		20710	W	C		NBR	
630	700	20		38610	W	C		NBR	
632	672	20		48900	W	C		NBR	
640	680	20		48901	W	C		NBR	
645	677	16		48902	W	C		NBR	
650	690	18		48903	W	C		NBR	
660	704	22.5		92920	W	C		NBR	
670	710	20		48907	W	C		NBR	
670	730	25		130179	W	A		FKM	
670	730	25		134118	W	A	S	FKM	
695	740	20		38611	W	C		NBR	
700	740	20		38612	W	C		NBR	
710	760	20		74551	W	B		NBR	
750	800	25		92922	W	C		NBR	

油封

尺寸



油封

尺寸



d1	d2	H	H2	产品编码	产品组	设计型号	形式	材质
760	800	20		40667	W	A		NBR
760	810	18		162450	W	C		NBR
790	830	23		55895	W	C		NBR
790	840	22		56592	W	A		NBR
840	890	27		56050	W	A	S	NBR
850.9	914.4	22.2		48908	W	C		NBR
860	900	20		44950	W	C		NBR
880	940	32		20253	W	C		NBR
933.45	984.25	22.22		92249	W	C		NBR
950	1000	20		48909	W	C		NBR
1060	1100	20		48910	W	C		NBR
1181.1	1231.9	22.23		48911	W	C		NBR



轴向密封

尺寸

产品编码	d1	d2	H	截面代码	材质
174187	10	24	3.5	1	FKM
174131	10	24	3.5	1	NBR
174132	11	26	3.5	1	NBR
174188	11	26	3.5	1	FKM
174189	12	26	3.5	1	FKM
174133	12	26	3.5	1	NBR
174134	14	30	4	1	NBR
174190	14	30	4	1	FKM
174191	15	30	4	1	FKM
174135	15	30	4	1	NBR
174229	15	32	4	2	FKM
174169	15	32	4	2	NBR
174192	16	32	4	1	FKM
174136	16	32	4	1	NBR
174137	17	32	4	1	NBR
174193	17	32	4	1	FKM
174170	17	34	4	2	NBR
174230	17	34	4	2	FKM
174194	18	33	4	1	FKM
174138	18	33	4	1	NBR
174078	20	35	4	1	NBR
174195	20	35	4	1	FKM
174171	20	37	4	2	NBR
174231	20	37	4	2	FKM
174139	22	40	4	1	NBR
174196	22	40	4	1	FKM
174197	24	40	4	1	FKM
174140	24	40	4	1	NBR
174076	25	40	4	1	NBR
174198	25	40	4	1	FKM
174172	25	42	4	2	NBR
174232	25	42	4	2	FKM
174141	26	40	4	1	NBR
174199	26	40	4	1	FKM
174200	28	43	4	1	FKM
174142	28	43	4	1	NBR
174082	30	47	4.5	1	NBR
174201	30	47	4.5	1	FKM
174080	30	48	4.5	2	NBR
174233	30	48	4.5	2	FKM
174143	32	49	4.5	1	NBR
174202	32	49	4.5	1	FKM
174144	35	52	4.5	1	NBR
174203	35	52	4.5	1	FKM
174173	35	53	4.5	2	NBR
174234	35	53	4.5	2	FKM
174145	38	55	4.5	1	NBR
174204	38	55	4.5	1	FKM
174205	40	57	4.5	1	FKM
174146	40	57	4.5	1	NBR
174235	40	58	4.5	2	FKM
174174	40	58	4.5	2	NBR
174206	41	57	4.5	1	FKM
174147	41	57	4.5	1	NBR
174148	42	59	4.5	1	NBR





轴向密封

尺寸



产品编码	d1	d2	H	截面代码	材质
174207	42	59	4.5	1	FKM
174081	45	62	4.5	1	NBR
174208	45	62	4.5	1	FKM
174175	45	63	4.5	2	NBR
174083	45	63	4.5	2	FKM
174149	48	65	4.5	1	NBR
82406	48	65	4.5	1	NBR
174209	48	65	4.5	1	FKM
174210	50	70	5.5	1	FKM
174150	50	70	5.5	1	NBR
174077	50	72	5.5	2	FKM
174176	50	72	5.5	2	NBR
174211	52	72	5.5	1	FKM
174151	52	72	5.5	1	NBR
174152	55	75	5.5	1	NBR
174212	55	75	5.5	1	FKM
174177	55	77	5.5	2	NBR
174236	55	77	5.5	2	FKM
174153	58	78	5.5	1	NBR
174213	58	78	5.5	1	FKM
174214	60	80	5.5	1	FKM
82407	60	80	5.5	1	NBR
174154	60	80	5.5	1	NBR
174079	60	82	5.5	2	FKM
174178	60	82	5.5	2	NBR
174215	62	82	5.5	1	FKM
174155	62	82	5.5	1	NBR
174156	65	85	5.5	1	NBR
174216	65	85	5.5	1	FKM
174179	65	87	5.5	2	NBR
174237	65	87	5.5	2	FKM
174157	68	88	5.5	1	NBR
174217	68	88	5.5	1	FKM
174218	70	90	5.5	1	FKM
45343	70	90	5.5	1	NBR
174158	70	90	5.5	1	NBR
174238	70	92	5.5	2	FKM
174180	70	92	5.5	2	NBR
174219	72	92	5.5	1	FKM
174159	72	92	5.5	1	NBR
174160	75	95	5.5	1	NBR
174220	75	95	5.5	1	FKM
174181	75	97	5.5	2	NBR
58900	75	97	5.5	2	NBR
126617	75	97	5.5	2	FKM
174239	75	97	5.5	2	FKM
174161	78	98	5.5	1	NBR
174221	78	98	5.5	1	FKM
174222	80	100	5.5	1	FKM
174162	80	100	5.5	1	NBR
174240	80	102	5.5	2	FKM
174182	80	102	5.5	2	NBR
45777	85	105	5.5	1	NBR
174223	85	105	5.5	1	FKM
174163	85	105	5.5	1	NBR

Any seal. Any time.



轴向密封

尺寸

产品编码	d1	d2	H	截面代码	材质
174241	85	107	5.5	2	FKM
174183	85	107	5.5	2	NBR
174164	90	110	5.5	1	NBR
174224	90	110	5.5	1	FKM
174184	90	112	5.5	2	NBR
174242	90	112	5.5	2	FKM
174165	95	115	5.5	1	NBR
174225	95	115	5.5	1	FKM
174185	95	117	5.5	2	NBR
174243	95	117	5.5	2	FKM
174166	100	120	5.5	1	NBR
174226	100	120	5.5	1	FKM
174186	100	122	5.5	2	NBR
174244	100	122	5.5	2	FKM
174167	105	125	5.5	1	NBR
174227	105	125	5.5	1	FKM
176298	110	130	5.5	1	FKM
179826	120	140	5.5	1	NBR
174168	135	159	6.5	1	NBR
174228	135	159	6.5	1	FKM
177541	190	214	5.5	1	FKM

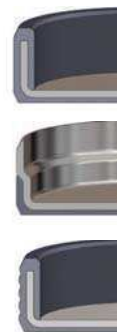



VA 50 NBR

尺寸



产品编码	产品型号	C	d	D	h1	H	d2	d1	H1
123483	VA50-3	2.7 - 3.5	2.5	5.5	2.1	3	C+1	C+4	2.5±0.3
123484	VA50-4	3.5 - 4.5	3.2	7.2	2.4	3.7	C+1	C+6	3±0.4
123485	VA50-5	4.5 - 5.5	4	8	2.4	3.7	C+1	C+6	3±0.4
123486	VA50-6	5.5 - 6.5	5	9	2.4	3.7	C+1	C+6	3±0.4
123487	VA50-7	6.5 - 8	6	10	2.4	3.7	C+1	C+6	3±0.4
123488	VA50-8	8 - 9.5	7	11	2.4	3.7	C+1	C+6	3±0.4
123489	VA50-10	9.5 - 11.5	9	15	3.4	5.5	C+2	C+9	4.5±0.6
123490	VA50-12	11.5 - 12.5	10.5	16.5	3.4	5.5	C+2	C+9	4.5±0.6
123491	VA50-14	13.5 - 15.5	12.5	18.5	3.4	5.5	C+2	C+9	4.5±0.6
123492	VA50-16	15.5 - 17.5	14	20	3.4	5.5	C+2	C+9	4.5±0.6
123493	VA50-18	17.5 - 19	16	22	3.4	5.5	C+2	C+9	4.5±0.6
123494	VA50-20	19 - 21	18	26	4.7	7.5	C+2	C+12	6±0.8
123495	VA50-22	21 - 24	20	28	4.7	7.5	C+2	C+12	6±0.8
126496	VA50-25	24 - 27	22	30	4.7	7.5	C+2	C+12	6±0.8
123497	VA50-28	27 - 29	25	33	4.7	7.5	C+3	C+12	6±0.8
123498	VA50-30	29 - 31	27	35	4.7	7.5	C+3	C+12	6±0.8
123499	VA50-32	31 - 33	29	37	4.7	7.5	C+3	C+12	6±0.8
123500	VA50-35	33 - 36	31	39	4.7	7.5	C+3	C+12	6±0.8
123501	VA50-38	36 - 38	34	42	4.7	7.5	C+3	C+12	6±0.8
123502	VA50-40	38 - 43	36	46	5.5	9	C+3	C+15	7±1
123503	VA50-45	43 - 48	40	50	5.5	9	C+3	C+15	7±1
123504	VA50-50	48 - 53	45	55	5.5	9	C+3	C+15	7±1
123505	VA50-55	53 - 58	49	59	5.5	9	C+3	C+15	7±1
123506	VA50-60	58 - 63	54	64	5.5	9	C+3	C+15	7±1
123507	VA50-65	63 - 68	58	68	5.5	9	C+3	C+15	7±1
123508	VA50-70	68 - 73	63	75	6.8	11	C+4	C+18	9±1.2
123509	VA50-75	73 - 78	67	79	6.8	11	C+4	C+18	9±1.2
123510	VA50-80	78 - 83	72	84	6.8	11	C+4	C+18	9±1.2
123511	VA50-85	83 - 88	76	88	6.8	11	C+4	C+18	9±1.2
123512	VA50-90	88 - 93	81	93	6.8	11	C+4	C+18	9±1.2
123513	VA50-95	93 - 98	85	97	6.8	11	C+4	C+18	9±1.2
123514	VA50-100	98 - 105	90	102	6.8	11	C+4	C+18	9±1.2
123515	VA50-110	105 - 115	99	113	7.9	12.8	C+4	C+21	10.5±1.5
123516	VA50-120	115 - 125	108	122	7.9	12.8	C+4	C+21	10.5±1.5
123517	VA50-130	125 - 135	117	131	7.9	12.8	C+4	C+21	10.5±1.5
123518	VA50-140	135 - 145	126	140	7.9	12.8	C+4	C+21	10.5±1.5
123519	VA50-150	145 - 155	135	149	7.9	12.8	C+4	C+21	10.5±1.5
123520	VA50-160	155 - 165	144	160	9	14.5	C+5	C+24	12±1.8
123521	VA50-170	165 - 175	153	169	9	14.5	C+5	C+24	12±1.8
123522	VA50-180	175 - 185	162	178	9	14.5	C+5	C+24	12±1.8
123523	VA50-190	185 - 195	171	187	9	14.5	C+5	C+24	12±1.8
123524	VA50-199	195 - 210	180	196	9	14.5	C+5	C+24	12±1.8
123525	VA50-200	190 - 210	180	210	14.3	25	C+10	C+45	20±4
123526	VA50-220	210 - 235	198	228	14.3	25	C+10	C+45	20±4
123527	VA50-250	235 - 265	225	255	14.3	25	C+10	C+45	20±4
123528	VA50-275	265 - 290	247	277	14.3	25	C+10	C+45	20±4
123529	VA50-300	290 - 310	270	300	14.3	25	C+10	C+45	20±4
123530	VA50-325	310 - 335	292	322	14.3	25	C+10	C+45	20±4
123531	VA50-350	335 - 365	315	345	14.3	25	C+10	C+45	20±4
123532	VA50-375	365 - 390	337	367	14.3	25	C+10	C+45	20±4
123533	VA50-400	390 - 430	360	390	14.3	25	C+10	C+45	20±4
123534	VA50-450	430 - 480	405	435	14.3	25	C+10	C+45	20±4
123535	VA50-500	480 - 530	450	480	14.3	25	C+10	C+45	20±4
123536	VA50-550	530 - 580	495	525	14.3	25	C+10	C+45	20±4
123537	VA50-600	580 - 630	540	570	14.3	25	C+10	C+45	20±4



产品编码 产品型号 C d D h1 H d2 d1 H1

VA 50 NBR

尺寸

26264	VA50-650	630 - 665	600	630	14.3	25	C+10	C+45	20±4
27384	VA50-700	665 - 705	630	660	14.3	25	C+10	C+45	20±4
26265	VA50-725	705 - 745	670	700	14.3	25	C+10	C+45	20±4
41194	VA50-750	745 - 785	705	735	14.3	25	C+10	C+45	20±4
16684	VA50-800	785 - 830	745	775	14.3	25	C+10	C+45	20±4
16685	VA50-850	830 - 875	785	815	14.3	25	C+10	C+45	20±4
26266	VA50-900	875 - 920	825	855	14.3	25	C+10	C+45	20±4
35010	VA50-950	920 - 965	865	895	14.3	25	C+10	C+45	20±4
27473	VA50-1000	965 - 1015	910	940	14.3	25	C+10	C+45	20±4
71773	VA50-1050	1015 - 1065	955	985	14.3	25	C+10	C+45	20±4
35045	VA50-1100	1065 - 1115	1000	1030	14.3	25	C+10	C+45	20±4
36903	VA50-1150	1115 - 1165	1045	1075	14.3	25	C+10	C+45	20±4 *
69606	VA50-1200	1165 - 1215	1090	1120	14.3	25	C+10	C+45	20±4 *
27385	VA50-1250	1215 - 1270	1135	1165	14.3	25	C+10	C+45	20±4 *
56734	VA50-1300	1270 - 1320	1180	1210	14.3	25	C+10	C+45	20±4 *
71774	VA50-1350	1320 - 1370	1225	1255	14.3	25	C+10	C+45	20±4 *
71775	VA50-1400	1370 - 1420	1270	1300	14.3	25	C+10	C+45	20±4 *
71776	VA50-1450	1420 - 1470	1315	1345	14.3	25	C+10	C+45	20±4 *
71777	VA50-1500	1470 - 1520	1360	1390	14.3	25	C+10	C+45	20±4 *
71778	VA50-1550	1520 - 1570	1405	1435	14.3	25	C+10	C+45	20±4 *
35875	VA50-1600	1570 - 1620	1450	1480	14.3	25	C+10	C+45	20±4 *
71779	VA50-1650	1620 - 1670	1495	1525	14.3	25	C+10	C+45	20±4 *
71780	VA50-1700	1670 - 1720	1540	1570	14.3	25	C+10	C+45	20±4 *
71781	VA50-1750	1720 - 1770	1585	1615	14.3	25	C+10	C+45	20±4 *
71782	VA50-1800	1770 - 1820	1630	1660	14.3	25	C+10	C+45	20±4 *
71783	VA50-1850	1820 - 1870	1675	1705	14.3	25	C+10	C+45	20±4 *
71784	VA50-1900	1870 - 1920	1720	1750	14.3	25	C+10	C+45	20±4 *
71785	VA50-1950	1920 - 1970	1765	1795	14.3	25	C+10	C+45	20±4 *
27445	VA50-2000	1970 - 2020	1810	1840	14.3	25	C+10	C+45	20±4 *

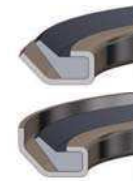

VS 50 NBR

尺寸

123597	VS50-5	4.5 - 5.5	4	8	3.9	5.2	C+1	C+6	4.5±0.4
123598	VS50-6	5.5 - 6.5	5	9	3.9	5.2	C+1	C+6	4.5±0.4
123599	VS50-7	6.5 - 8	6	10	3.9	5.2	C+1	C+6	4.5±0.4
123600	VS50-8	8 - 9.5	7	11	3.9	5.2	C+1	C+6	4.5±0.4
123601	VS50-10	9.5 - 11.5	9	15	5.6	7.7	C+2	C+9	6.7±0.6
123602	VS50-12	11.5 - 13.5	10.5	16.5	5.6	7.7	C+2	C+9	6.7±0.6
123603	VS50-14	13.5 - 15.5	12.5	18.5	5.6	7.7	C+2	C+9	6.7±0.6
123604	VS50-16	15.5 - 17.5	14	20	5.6	7.7	C+2	C+9	6.7±0.6
123605	VS50-18	17.5 - 19	16	22	5.6	7.7	C+2	C+9	6.7±0.6
123606	VS50-20	19 - 21	18	26	7.9	10.5	C+2	C+12	9±0.8
123607	VS50-22	21 - 24	20	28	7.9	10.5	C+2	C+12	9±0.8
123608	VS50-25	24 - 27	22	30	7.9	10.5	C+2	C+12	9±0.8
123609	VS50-28	27 - 29	25	33	7.9	10.5	C+3	C+12	9±0.8
123610	VS50-30	29 - 31	27	35	7.9	10.5	C+3	C+12	9±0.8
123611	VS50-32	31 - 33	29	37	7.9	10.5	C+3	C+12	9±0.8
123612	VS50-35	33 - 36	31	39	7.9	10.5	C+3	C+12	9±0.8
123613	VS50-38	36 - 38	34	42	7.9	10.5	C+3	C+12	9±0.8
123614	VS50-40	38 - 43	36	46	9.5	13	C+3	C+15	11±1
123615	VS50-45	43 - 48	40	50	9.5	13	C+3	C+15	11±1
123616	VS50-50	48 - 53	45	55	9.5	13	C+3	C+15	11±1
123617	VS50-55	53 - 58	49	59	9.5	13	C+3	C+15	11±1
123618	VS50-60	58 - 63	54	64	9.5	13	C+3	C+15	11±1
123619	VS50-65	63 - 68	58	68	9.5	13	C+3	C+15	11±1
123620	VS50-70	68 - 73	63	75	11.3	15.5	C+4	C+18	13.5±1.2
123621	VS50-75	73 - 78	67	79	11.3	15.5	C+4	C+18	13.5±1.2



*vulcanised



VS 50 NBR

尺寸



产品编码	产品型号	C	d	D	h1	H	d2	d1	H1
123622	VS50-80	78 - 83	72	84	11.3	15.5	C+4	C+18	13.5±1.2
123623	VS50-85	83 - 88	76	88	11.3	15.5	C+4	C+18	13.5±1.2
123624	VS50-90	88 - 93	81	93	11.3	15.5	C+4	C+18	13.5±1.2
123625	VS50-95	93 - 98	85	97	11.3	15.5	C+4	C+18	13.5±1.2
123626	VS50-100	98 - 105	90	102	11.3	15.5	C+4	C+18	13.5±1.2
123627	VS50-110	105 - 115	99	113	13.1	18	C+4	C+21	15.5±1.5
123628	VS50-120	115 - 125	108	122	13.1	18	C+4	C+21	15.5±1.5
123629	VS50-130	125 - 135	117	131	13.1	18	C+4	C+21	15.5±1.5
123630	VS50-140	135 - 145	126	140	13.1	18	C+4	C+21	15.5±1.5
123631	VS50-150	145 - 155	135	149	13.1	18	C+4	C+21	15.5±1.5
123632	VS50-160	155 - 165	144	160	15	20.5	C+5	C+24	18±1.8
123633	VS50-170	165 - 175	153	169	15	20.5	C+5	C+24	18±1.8
123634	VS50-180	175 - 185	162	178	15	20.5	C+5	C+24	18±1.8
123635	VS50-190	185 - 195	171	187	15	20.5	C+5	C+24	18±1.8
123636	VS50-199	195 - 210	180	196	15	20.5	C+5	C+24	18±1.8

VL 50 NBR

尺寸



123568	VL50-110	105 - 115	99	105.5	6	10.5	C+5	C+20	8±1.5
123569	VL50-120	115 - 125	108	114.5	6	10.5	C+5	C+20	8±1.5
123570	VL50-130	125 - 135	117	123.5	6	10.5	C+5	C+20	8±1.5
123570	VL50-140	135 - 145	126	132.5	6	10.5	C+5	C+20	8±1.5
123572	VL50-150	145 - 155	135	141.5	6	10.5	C+5	C+20	8±1.5
123573	VL50-160	155 - 165	144	150.5	6	10.5	C+5	C+20	8±1.5
123574	VL50-170	165 - 175	153	159.5	6	10.5	C+5	C+20	8±1.5
123575	VL50-180	175 - 185	162	168.5	6	10.5	C+5	C+20	8±1.5
123576	VL50-190	185 - 195	171	177.5	6	10.5	C+5	C+20	8±1.5
123577	VL50-200	195 - 210	182	188.5	6	10.5	C+5	C+20	8±1.5
123578	VL50-220	210 - 233	198	204.5	6	10.5	C+5	C+20	8±1.5
123579	VL50-250	233 - 260	225	231.5	6	10.5	C+5	C+20	8±1.5
123580	VL50-275	260 - 285	247	253.5	6	10.5	C+5	C+20	8±1.5
123581	VL50-300	285 - 310	270	276.5	6	10.5	C+5	C+20	8±1.5
123582	VL50-325	310 - 335	292	298.5	6	10.5	C+5	C+20	8±1.5
123583	VL50-350	335 - 365	315	321.5	6	10.5	C+5	C+20	8±1.5
123584	VL50-375	365 - 385	337	343.5	6	10.5	C+5	C+20	8±1.5
123585	VL50-400	385 - 410	360	366.5	6	10.5	C+5	C+20	8±1.5
123586	VL50-425	410 - 440	382	388.5	6	10.5	C+5	C+20	8±1.5
123587	VL50-450	440 - 475	405	411.5	6	10.5	C+5	C+20	8±1.5
123588	VL50-500	475 - 510	450	456.5	6	10.5	C+5	C+20	8±1.5
46234	VL50-525	510 - 540	472	478.5	6	10.5	C+5	C+20	8±1.5
123589	VL50-550	540 - 575	495	501.5	6	10.5	C+5	C+20	8±1.5
123590	VL50-600	575 - 625	540	546.5	6	10.5	C+5	C+20	8±1.5
123591	VL50-650	625 - 675	600	606.5	6	10.5	C+5	C+20	8±1.5
123592	VL50-700	675 - 710	630	636.5	6	10.5	C+5	C+20	8±1.5
167544	VL50-725	710 - 740	670	676.5	6	10.5	C+5	C+20	8±1.5 *
123593	VL50-750	740 - 775	705	711.5	6	10.5	C+5	C+20	8±1.5
123594	VL50-800	775 - 825	745	751.5	6	10.5	C+5	C+20	8±1.5 *
123595	VL50-850	825 - 875	785	791.5	6	10.5	C+5	C+20	8±1.5
123596	VL50-900	875 - 925	825	831.5	6	10.5	C+5	C+20	8±1.5
165112	VL50-950	925 - 975	865	871.5	6	10.5	C+5	C+20	8±1.5 *
79420	VL50-1000	975 - 1025	910	916.5	6	10.5	C+5	C+20	8±1.5 *
166758	VL50-1050	1025 - 1075	955	961.5	6	10.5	C+5	C+20	8±1.5 *
167585	VL50-1100	1075 - 1125	1000	1006.5	6	10.5	C+5	C+20	8±1.5 *
76115	VL50-1200	1175 - 1225	1090	1096.5	6	10.5	C+5	C+20	8±1.5 *
69608	VL50-2000	1975 - 2025	1810	1816.5	6	10.5	C+5	C+20	8±1.5 *



**VA 50 FKM**

尺寸

产品编码	产品型号	C	d	D	h1	H	d2	d1	H1
62133	VA50-3	2.7 - 3.5	2.5	5.5	2.1	3	C+1	C+4	2.5±0.3
62134	VA50-4	3.5 - 4.5	3.2	7.2	2.4	3.7	C+1	C+6	3±0.4
44103	VA50-5	4.5 - 5.5	4	8	2.4	3.7	C+1	C+6	3±0.4
62135	VA50-6	5.5 - 6.5	5	9	2.4	3.7	C+1	C+6	3±0.4
62136	VA50-7	6.5 - 8	6	10	2.4	3.7	C+1	C+6	3±0.4
62137	VA50-8	8 - 9.5	7	11	2.4	3.7	C+1	C+6	3±0.4
37437	VA50-10	9.5 - 11.5	9	15	3.4	5.5	C+2	C+9	4.5±0.6
62138	VA50-12	11.5 - 12.5	10.5	16.5	3.4	5.5	C+2	C+9	4.5±0.6
62139	VA50-14	13.5 - 15.5	12.5	18.5	3.4	5.5	C+2	C+9	4.5±0.6
56127	VA50-16	15.5 - 17.5	14	20	3.4	5.5	C+2	C+9	4.5±0.6
36036	VA50-18	17.5 - 19	16	22	3.4	5.5	C+2	C+9	4.5±0.6
39208	VA50-20	19 - 21	18	26	4.7	7.5	C+2	C+12	6±0.8
62140	VA50-22	21 - 24	20	28	4.7	7.5	C+2	C+12	6±0.8
36553	VA50-25	24 - 27	22	30	4.7	7.5	C+2	C+12	6±0.8
37602	VA50-28	27 - 29	25	33	4.7	7.5	C+3	C+12	6±0.8
49455	VA50-30	29 - 31	27	35	4.7	7.5	C+3	C+12	6±0.8
62141	VA50-32	31 - 33	29	37	4.7	7.5	C+3	C+12	6±0.8
62142	VA50-35	33 - 36	31	39	4.7	7.5	C+3	C+12	6±0.8
62143	VA50-38	36 - 38	34	42	4.7	7.5	C+3	C+12	6±0.8
36931	VA50-40	38 - 43	36	46	5.5	9	C+3	C+15	7±1
44692	VA50-45	43 - 48	40	50	5.5	9	C+3	C+15	7±1
22379	VA50-50	48 - 53	45	55	5.5	9	C+3	C+15	7±1
56950	VA50-55	53 - 58	49	59	5.5	9	C+3	C+15	7±1
36555	VA50-60	58 - 63	54	64	5.5	9	C+3	C+15	7±1
37455	VA50-65	63 - 68	58	68	5.5	9	C+3	C+15	7±1
35344	VA50-70	68 - 73	63	75	6.8	11	C+4	C+18	9±1.2
35345	VA50-75	73 - 78	67	79	6.8	11	C+4	C+18	9±1.2
37260	VA50-80	78 - 83	72	84	6.8	11	C+4	C+18	9±1.2
35610	VA50-85	83 - 88	76	88	6.8	11	C+4	C+18	9±1.2
37459	VA50-90	88 - 93	81	93	6.8	11	C+4	C+18	9±1.2
35488	VA50-95	93 - 98	85	97	6.8	11	C+4	C+18	9±1.2
34854	VA50-100	98 - 105	90	102	6.8	11	C+4	C+18	9±1.2
36932	VA50-110	105 - 115	99	113	7.9	12.8	C+4	C+21	10.5±1.5
35613	VA50-120	115 - 125	108	122	7.9	12.8	C+4	C+21	10.5±1.5
37964	VA50-130	125 - 135	117	131	7.9	12.8	C+4	C+21	10.5±1.5
44693	VA50-140	135 - 145	126	140	7.9	12.8	C+4	C+21	10.5±1.5
22378	VA50-150	145 - 155	135	149	7.9	12.8	C+4	C+21	10.5±1.5
55879	VA50-160	155 - 165	144	160	9	14.5	C+5	C+24	12±1.8
24715	VA50-170	165 - 175	153	169	9	14.5	C+5	C+24	12±1.8
35109	VA50-180	175 - 185	162	178	9	14.5	C+5	C+24	12±1.8
37965	VA50-190	185 - 195	171	187	9	14.5	C+5	C+24	12±1.8
37427	VA50-199	195 - 210	180	196	9	14.5	C+5	C+24	12±1.8
36916	VA50-200	190 - 210	180	210	14.3	25	C+10	C+45	20±4
34919	VA50-220	210 - 235	198	228	14.3	25	C+10	C+45	20±4
36654	VA50-250	235 - 265	225	255	14.3	25	C+10	C+45	20±4
41577	VA50-275	265 - 290	247	277	14.3	25	C+10	C+45	20±4
36653	VA50-300	290 - 310	270	300	14.3	25	C+10	C+45	20±4
40235	VA50-325	310 - 335	292	322	14.3	25	C+10	C+45	20±4
70444	VA50-350	335 - 365	315	345	14.3	25	C+10	C+45	20±4
36917	VA50-375	365 - 390	337	367	14.3	25	C+10	C+45	20±4
34918	VA50-400	390 - 430	360	390	14.3	25	C+10	C+45	20±4
35883	VA50-450	430 - 480	405	435	14.3	25	C+10	C+45	20±4
40448	VA50-500	480 - 530	450	480	14.3	25	C+10	C+45	20±4
39580	VA50-550	530 - 580	495	525	14.3	25	C+10	C+45	20±4
40910	VA50-600	580 - 630	540	570	14.3	25	C+10	C+45	20±4



**VA 50 FKM**

尺寸



产品编码	产品型号	C	d	D	h1	H	d2	d1	H1
36676	VA50-650	630 - 665	600	630	14.3	25	C+10	C+45	20±4
64883	VA50-700	665 - 705	630	660	14.3	25	C+10	C+45	20±4
59558	VA50-725	705 - 745	670	700	14.3	25	C+10	C+45	20±4
56375	VA50-750	745 - 785	705	735	14.3	25	C+10	C+45	20±4
69327	VA50-800	785 - 830	745	775	14.3	25	C+10	C+45	20±4
69740	VA50-850	830 - 875	785	815	14.3	25	C+10	C+45	20±4
24280	VA50-900	875 - 920	825	855	14.3	25	C+10	C+45	20±4
24281	VA50-950	920 - 965	865	895	14.3	25	C+10	C+45	20±4
77761	VA50-1000	965 - 1015	910	940	14.3	25	C+10	C+45	20±4
45403	VA50-1050	1015 - 1065	955	985	14.3	25	C+10	C+45	20±4
38079	VA50-1100	1065 - 1115	1000	1030	14.3	25	C+10	C+45	20±4 *
35607	VA50-1150	1115 - 1165	1045	1075	14.3	25	C+10	C+45	20±4 *
36705	VA50-1200	1165 - 1215	1090	1120	14.3	25	C+10	C+45	20±4 *
46092	VA50-1250	1215 - 1270	1135	1165	14.3	25	C+10	C+45	20±4 *
56724	VA50-1300	1270 - 1320	1180	1210	14.3	25	C+10	C+45	20±4 *
45404	VA50-1350	1320 - 1370	1225	1255	14.3	25	C+10	C+45	20±4 *
45405	VA50-1400	1370 - 1420	1270	1300	14.3	25	C+10	C+45	20±4 *
6583	VA50-1450	1420 - 1470	1315	1345	14.3	25	C+10	C+45	20±4 *
161425	VA50-1500	1470 - 1520	1360	1390	14.3	25	C+10	C+45	20±4 *
28630	VA50-1550	1520 - 1570	1405	1435	14.3	25	C+10	C+45	20±4 *
45410	VA50-1600	1570 - 1620	1450	1480	14.3	25	C+10	C+45	20±4 *
28639	VA50-1650	1620 - 1670	1495	1525	14.3	25	C+10	C+45	20±4 *
45411	VA50-1700	1670 - 1720	1540	1570	14.3	25	C+10	C+45	20±4 *
45412	VA50-1750	1720 - 1770	1585	1615	14.3	25	C+10	C+45	20±4 *
45415	VA50-1800	1770 - 1820	1630	1660	14.3	25	C+10	C+45	20±4 *
45416	VA50-1850	1820 - 1870	1675	1705	14.3	25	C+10	C+45	20±4 *
45421	VA50-1900	1870 - 1920	1720	1750	14.3	25	C+10	C+45	20±4 *
28643	VA50-1950	1920 - 1970	1765	1795	14.3	25	C+10	C+45	20±4 *
45422	VA50-2000	1970 - 2020	1810	1840	14.3	25	C+10	C+45	20±4 *

VS 50 FKM

尺寸



62146	VS50-5	4.5 - 5.5	4	8	3.9	5.2	C+1	C+6	4.5±0.4
62147	VS50-6	5.5 - 6.5	5	9	3.9	5.2	C+1	C+6	4.5±0.4
27704	VS50-7	6.5 - 8	6	10	3.9	5.2	C+1	C+6	4.5±0.4
62148	VS50-8	8 - 9.5	7	11	3.9	5.2	C+1	C+6	4.5±0.4
26256	VS50-10	9.5 - 11.5	9	15	5.6	7.7	C+2	C+9	6.7±0.6
62149	VS50-12	11.5 - 13.5	10.5	16.5	5.6	7.7	C+2	C+9	6.7±0.6
62150	VS50-14	13.5 - 15.5	12.5	18.5	5.6	7.7	C+2	C+9	6.7±0.6
62151	VS50-16	15.5 - 17.5	14	20	5.6	7.7	C+2	C+9	6.7±0.6
26255	VS50-18	17.5 - 19	16	22	5.6	7.7	C+2	C+9	6.7±0.6
37062	VS50-20	19 - 21	18	26	7.9	10.5	C+2	C+12	9±0.8
62152	VS50-22	21 - 24	20	28	7.9	10.5	C+2	C+12	9±0.8
36554	VS50-25	24 - 27	22	30	7.9	10.5	C+2	C+12	9±0.8
42591	VS50-28	27 - 29	25	33	7.9	10.5	C+3	C+12	9±0.8
38226	VS50-30	29 - 31	27	35	7.9	10.5	C+3	C+12	9±0.8
62153	VS50-32	31 - 33	29	37	7.9	10.5	C+3	C+12	9±0.8
34911	VS50-35	33 - 36	31	39	7.9	10.5	C+3	C+12	9±0.8
59658	VS50-38	36 - 38	34	42	7.9	10.5	C+3	C+12	9±0.8
21550	VS50-40	38 - 43	36	46	9.5	13	C+3	C+15	11±1
34912	VS50-45	43 - 48	40	50	9.5	13	C+3	C+15	11±1
34913	VS50-50	48 - 53	45	55	9.5	13	C+3	C+15	11±1
34917	VS50-55	53 - 58	49	59	9.5	13	C+3	C+15	11±1
36556	VS50-60	58 - 63	54	64	9.5	13	C+3	C+15	11±1
21552	VS50-65	63 - 68	58	68	9.5	13	C+3	C+15	11±1
34855	VS50-70	68 - 73	63	75	11.3	15.5	C+4	C+18	13.5±1.2
37456	VS50-75	73 - 78	67	79	11.3	15.5	C+4	C+18	13.5±1.2

*vulcanised

Any seal. Any time.

www.dichtomatik.de



产品编码	产品型号	C	d	D	h1	H	d2	d1	H1
21551	VS50-80	78 - 83	72	84	11.3	15.5	C+4	C+18	13.5±1.2
37457	VS50-85	83 - 88	76	88	11.3	15.5	C+4	C+18	13.5±1.2
37458	VS50-90	88 - 93	81	93	11.3	15.5	C+4	C+18	13.5±1.2
37460	VS50-95	93 - 98	85	97	11.3	15.5	C+4	C+18	13.5±1.2
35611	VS50-100	98 - 105	90	102	11.3	15.5	C+4	C+18	13.5±1.2
21553	VS50-110	105 - 115	99	113	13.1	18	C+4	C+21	15.5±1.5
37461	VS50-120	115 - 125	108	122	13.1	18	C+4	C+21	15.5±1.5
37952	VS50-130	125 - 135	117	131	13.1	18	C+4	C+21	15.5±1.5
27482	VS50-140	135 - 145	126	140	13.1	18	C+4	C+21	15.5±1.5
57013	VS50-150	145 - 155	135	149	13.1	18	C+4	C+21	15.5±1.5
24376	VS50-160	155 - 165	144	160	15	20.5	C+5	C+24	18±1.8
36043	VS50-170	165 - 175	153	169	15	20.5	C+5	C+24	18±1.8
35952	VS50-180	175 - 185	162	178	15	20.5	C+5	C+24	18±1.8
37426	VS50-190	185 - 195	171	187	15	20.5	C+5	C+24	18±1.8
36044	VS50-199	195 - 210	180	196	15	20.5	C+5	C+24	18±1.8
45809	VL50-110	105 - 115	99	105.5	6	10.5	C+5	C+20	8±1.5
29726	VL50-120	115 - 125	108	114.5	6	10.5	C+5	C+20	8±1.5
45815	VL50-130	125 - 135	117	123.5	6	10.5	C+5	C+20	8±1.5
44405	VL50-140	135 - 145	126	132.5	6	10.5	C+5	C+20	8±1.5
72420	VL50-150	145 - 155	135	141.5	6	10.5	C+5	C+20	8±1.5
81930	VL50-160	155 - 165	144	150.5	6	10.5	C+5	C+20	8±1.5
65690	VL50-170	165 - 175	153	159.5	6	10.5	C+5	C+20	8±1.5
78092	VL50-180	175 - 185	162	168.5	6	10.5	C+5	C+20	8±1.5
74006	VL50-190	185 - 195	171	177.5	6	10.5	C+5	C+20	8±1.5
81535	VL50-200	195 - 210	182	188.5	6	10.5	C+5	C+20	8±1.5
35519	VL50-220	210 - 233	198	204.5	6	10.5	C+5	C+20	8±1.5
35290	VL50-250	233 - 260	225	231.5	6	10.5	C+5	C+20	8±1.5
36369	VL50-275	260 - 285	247	253.5	6	10.5	C+5	C+20	8±1.5
37466	VL50-300	285 - 310	270	276.5	6	10.5	C+5	C+20	8±1.5
78093	VL50-325	310 - 335	292	298.5	6	10.5	C+5	C+20	8±1.5
74053	VL50-350	335 - 365	315	321.5	6	10.5	C+5	C+20	8±1.5
45816	VL50-375	365 - 385	337	343.5	6	10.5	C+5	C+20	8±1.5
37417	VL50-400	385 - 41	360	366.5	6	10.5	C+5	C+20	8±1.5
76766	VL50-425	410 - 440	382	388.5	6	10.5	C+5	C+20	8±1.5
37418	VL50-450	440 - 475	405	411.5	6	10.5	C+5	C+20	8±1.5
45817	VL50-500	475 - 510	450	456.5	6	10.5	C+5	C+20	8±1.5
46236	VL50-525	510 - 540	472	478.5	6	10.5	C+5	C+20	8±1.5
7597	VL50-550	540 - 575	495	501.5	6	10.5	C+5	C+20	8±1.5
45819	VL50-600	575 - 625	540	546.5	6	10.5	C+5	C+20	8±1.5 *
45820	VL50-650	625 - 675	600	606.5	6	10.5	C+5	C+20	8±1.5 *
6965	VL50-700	675 - 710	630	636.5	6	10.5	C+5	C+20	8±1.5 *
167543	VL50-725	710 - 740	670	676.5	6	10.5	C+5	C+20	8±1.5 *
45821	VL50-750	740 - 775	705	711.5	6	10.5	C+5	C+20	8±1.5 *
45822	VL50-800	775 - 825	745	751.5	6	10.5	C+5	C+20	8±1.5 *
45823	VL50-850	825 - 875	785	791.5	6	10.5	C+5	C+20	8±1.5



VS 50 FKM

尺寸



VL 50 FKM

尺寸



*vulcanised



端盖

尺寸

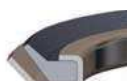

产品编码	d1	d2	截面代码	材质
108672	13	4.5	1	FKM
70484	13	4.5	1	NBR
43522	14	3	1	NBR
110224	14	3	1	FKM
108673	16	4	1	FKM
70485	16	4	1	NBR
117809	18	3	1	NBR
70486	19	3.2	1	NBR
108674	19	3.2	1	FKM
133021	19	5.5	1	NBR
108675	19	7	1	FKM
70488	19	7.5	1	NBR
108676	19	7.5	1	FKM
70487	19	7	1	NBR
108677	20	4	1	FKM
70489	20	4	1	NBR
117810	21	3	1	NBR
108678	21	4	1	FKM
70490	21	4	1	NBR
108679	22	4	1	FKM
120753	22	5	1	NBR
153012	22	6	1	NBR
108680	22	7	1	FKM
70491	22	4	1	NBR
58906	22	7	1	NBR
117509	24	7	1	NBR
66367	24	5	1	NBR
162149	25	5	1	NBR
70492	25	15	1	NBR
108681	25	15	1	FKM
118153	25	7	1	NBR
108682	26	4	1	FKM
108683	26	6.5	1	FKM
130618	26	7	1	NBR
55893	26	4	1	NBR
58907	26	6.5	1	NBR
108684	28	4	1	FKM
108685	28	7	1	FKM
176340	28	9	1	NBR
70493	28	4	1	NBR
128142	28	5	1	NBR
56946	28	7	1	NBR
66369	30	5	1	NBR
43363	30	7	1	NBR
156412	30	7	1	FKM
108686	30	8	1	FKM
124820	30	6	1	NBR
58908	30	8	1	NBR
110226	32	5	1	FKM
108687	32	7	1	FKM
108688	32	9.5	1	FKM
82949	32	5	1	NBR
70494	32	7	1	NBR
56185	32	9.5	1	NBR
110227	35	4.5	1	FKM

Any seal. Any time.



端盖

尺寸

产品编码	d1	d2	截面代码	材质
130619	35	5	1	NBR
172773	35	7	1	NBR
108689	35	7	1	FKM
108690	35	8	1	FKM
128122	35	10	1	NBR
70496	35	13	1	NBR
108691	35	13	1	FKM
84187	35	4.5	1	NBR
70495	35	7	1	NBR
24249	35	8	1	NBR
166530	36	7	1	NBR
108692	37	5	1	FKM
130620	37	7	1	NBR
156413	37	7	1	FKM
108693	37	10	1	FKM
70497	37	5	1	NBR
58909	37	10	1	NBR
110228	39	4.5	1	FKM
110229	39	5	1	FKM
82267	39	5	1	NBR
48454	39	4	1	NBR
110230	40	4.5	1	FKM
72747	40	7	1	VMQ
130626	40	7	1	NBR
72778	40	7	1	FKM
156495	40	10	1	NBR
186630	40	25	1	NBR
84188	40	4.5	1	NBR
34908	40	7	1	NBR
87131	42	6	1	NBR
110231	42	6	1	FKM
108694	42	7	1	FKM
108695	42	9.5	1	FKM
70498	42	7	1	NBR
58910	42	9.5	1	NBR
134066	45	5	1	NBR
110232	45	7	1	FKM
84133	45	7	1	NBR
115032	47	4	1	FKM
43535	47	4	1	NBR
108696	47	6.5	1	FKM
108697	47	7	1	FKM
156189	47	8	1	NBR
108698	47	10	1	FKM
58911	47	6.5	1	NBR
70499	47	7	1	NBR
24173	47	10	1	NBR
108699	48	4	1	FKM
108700	48	5	1	FKM
108701	48	6.6	1	FKM
70502	48	6.6	1	NBR
174876	48	7	1	NBR
70500	48	4	1	NBR
70501	48	5	1	NBR
110233	50	5	1	FKM





端盖

尺寸

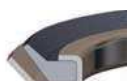

产品编码	d1	d2	截面代码	材质
130622	50	9	1	NBR
110234	50	10	1	FKM
82268	50	5	1	NBR
90042	50	10	1	NBR
108702	52	6.5	1	FKM
108703	52	7	1	FKM
108704	52	10	1	FKM
58912	52	6.5	1	NBR
70503	52	7	1	NBR
24174	52	10	1	NBR
108705	55	9	1	FKM
108706	55	10	1	FKM
70504	55	9	1	NBR
36520	55	10	1	NBR
108707	60	7	1	FKM
110235	60	8	1	FKM
1102361	60	10	1	FKM
68992	60	7	1	NBR
81544	60	8	1	NBR
74778	60	10	1	NBR
108708	62	7	1	FKM
108709	62	8	1	FKM
108710	62	10	1	FKM
108711	62	12	1	FKM
70505	62	7	1	NBR
37673	62	8	1	NBR
70506	62	10	1	NBR
70507	62	12	1	NBR
148893	63.7	7.8	1	NBR
125009	65	10	1	NBR
108712	68	8	1	FKM
108713	68	8.5	1	FKM
70508	68	8.5	1	NBR
58913	68	8	1	NBR
134067	70	9	1	NBR
108714	72	9	1	FKM
108715	72	10	1	FKM
116810	72	7	1	NBR
24175	72	9	1	NBR
70509	72	10	1	NBR
108716	75	7	1	FKM
156418	75	8	1	FKM
108717	75	12	1	FKM
58914	75	7	1	NBR
34909	75	12	1	NBR
81534	76.2	10	1	NBR
108718	80	7	1	FKM
179935	80	8	1	NBR
108719	80	10	1	FKM
108720	80	12	1	FKM
69451	80	7	1	NBR
70510	80	10	1	NBR
24383	80	12	1	NBR
130621	85	10	1	NBR
186965	85	10	1	FKM

Any seal. Any time.



端盖

尺寸

产品编码	d1	d2	截面代码	材质
108721	85	12	1	FKM
58915	85	12	1	NBR
108722	90	8	1	FKM
108723	90	10	1	FKM
108724	90	12	1	FKM
58916	90	8	1	NBR
70511	90	10	1	NBR
25954	90	12	1	NBR
134116	92	10	1	NBR
159472	95	10	1	NBR
108725	100	10	1	FKM
108726	100	12	1	FKM
70512	100	10	1	NBR
58917	100	12	1	NBR
43536	106	15	1	NBR
110237	106	15	1	FKM
181841	110	8	1	NBR
108727	110	10	1	FKM
108728	110	12	1	FKM
70513	110	10	1	NBR
58918	110	12	1	NBR
118776	115	12	1	NBR
108729	120	12	1	FKM
110238	120	13	1	FKM
43538	120	13	1	NBR
58919	120	12	1	NBR
108730	125	12	1	FKM
58920	125	12	1	NBR
144544	128.6	12	1	NBR
108731	130	12	1	FKM
110239	130	13	1	FKM
43564	130	13	1	NBR
58921	130	12	1	NBR
130623	140	12	1	NBR
108732	140	15	1	FKM
58922	140	15	1	NBR
110240	145	12	1	FKM
84936	145	12	1	NBR
175070	150	12	1	NBR
5052	150	13	1	NBR
110241	150	13	1	FKM
108733	150	15	1	FKM
58923	150	15	1	NBR
130624	160	12	1	NBR
108734	160	15	1	FKM
58924	160	15	1	NBR
108735	168	12	1	FKM
58925	168	12	1	NBR
130625	170	12	1	NBR
108736	170	15	1	FKM
58926	170	15	1	NBR
108737	180	12	1	FKM
58927	180	12	1	NBR
117539	190	12	1	NBR
108738	200	13	1	FKM





端盖

尺寸

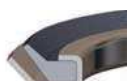

产品编码	d1	d2	截面代码	材质
58928	200	13	1	NBR
110242	210	15	1	FKM
21320	210	15	1	NBR
117540	215	15	1	NBR
134423	220	15	1	NBR
58929	230	14	1	NBR
108739	230	14	1	FKM
117541	240	15	1	NBR
124983	250	15	1	NBR
124984	260	15	1	NBR
124985	290	15	1	NBR
162925	290	18	1	NBR
166550	310	16	1	NBR



轴修复套

尺寸

Item No.	Ref. No.	d1	D	X	Y
176631	99049	12	15.5	6	8.4
179404	99055	14	19.1	6.3	9.9
176633	99059	15	19.1	5	9
179405	99062	15.88	19.1	8	10.3
176632	99058	16	18.2	8	11.1
176634	99068	17	22.2	8	11
176637	99082	17.93	24.4	8	11
176635	99076	19.05	24	8	11.1
176636	99078	20	23.6	8	11
176638	99084	22	30.2	6.6	9.1
176639	99085	22	30.2	8	12
115928	99092	24	28.7	8	11.1
150801	99098	25	33	8	11
176640	99100	25.4	31	8	11.1
176641	99103	26.01	33.4	8	12
117578	99111	28	34.9	9.5	12.7
179357	99116	28.58	38.1	9.5	12.7
176644	99120	29.36	34.3	9.5	12.7
176645	99122	29.85	35.6	8	11.1
176642	99114	30	35.6	8	11
176643	99118	30.18	35.6	8	11.1
176646	99125	31.8	38.1	8	11.1
176647	99128	32	38.1	8	11.1
176648	99131	33.35	40.5	12.7	15.9
176649	99138	34.93	41.6	12.7	15.9
176650	99139	34.93	41.6	13	16
176651	99146	36	45.2	13	17
176652	99147	38	45.2	13	17
176653	99150	38.1	45.2	9.5	12.7
179406	99149	38.1	45.2	14.3	17.5
179358	99152	38.68	47.2	11.1	14.3
176655	99155	39.42	47.2	11.1	14.3
179407	99156	39.7	47.2	14.3	17.5
176654	99153	40	46.9	9.9	12.9
27897	99157	40.08	47	13	16
176656	99163	41	49.2	12.7	15.9
176658	99166	41.9	53	11.3	14.5
176660	99169	41.9	53	14.3	17.5
176657	99165	42.06	53	14	17.5
176659	99168	42.88	48.4	14.3	17.5
176662	99171	43.66	51.6	14.3	17.5
176661	99170	44.17	52.4	9.5	12.7
179408	99174	44.45	52.4	14.3	17.5
176665	99176	44.86	52.4	14.3	17.5
176666	99177	45	53	14	17
176667	99181	46.05	53.1	14.3	17.5
176668	99189	48.03	56	14	17
176669	99196	50	57	14	17
176670	99198	50.3	58.8	14.3	17.9
176671	99199	50.8	61.1	14.3	17.5
179409	99204	52	62.7	12.7	15.9
176672	99210	53.98	61.5	12.7	19.1
179410	99212	53.98	61.5	19.8	23.8
176673	99215	55	62	20	23
179411	99220	56	64.3	12.7	15.9





轴修复套

尺寸



产品编码	Ref. No.	d1	D	X	Y
176674	99227	57.15	64.3	8	11.1
179412	99225	57.15	64.3	19.8	23.8
176675	99233	59.13	69.8	19.1	22.2
176677	99241	60	70.7	9.4	11.4
116814	99235	60	70.7	20	23
176676	99240	60.33	69.8	13.4	17.4
179413	99242	61.93	71.8	12.7	15.9
176678	99244	62	71.8	12.7	15.9
176679	99254	65	72.4	20	23
176680	99256	65.1	73.4	19.8	23.8
176681	99266	68	79.4	19.1	22.2
176683	99272	69.85	79.4	10.3	14.3
176684	99274	69.85	79.4	19.8	23.79
176685	99275	69.85	79.4	19.8	23.8
176682	99269	69.85	79.4	28.6	31.8
176686	99276	70	79.4	20	24
176687	99281	71.45	81	15.1	17.5
176688	99284	72	81.9	19.1	22.2
176689	99289	75	83.1	15.1	17.5
176690	99294	75	84	22	26
176691	99298	76.02	85.3	14.3	17.5
176692	99311	79.38	89.7	17.5	20.6
116813	99313	79.91	89.9	19.1	22.5
176694	99317	80	90	11	15
176693	99315	80	90	21	24
176695	99331	84.07	93.7	20.6	25.4
176696	99332	84.89	94	17	21
121330	99333	84.89	94	21	25
176697	99334	85	90.9	10.1	12.7
179414	99350	88.9	97.6	20.6	25.4
176699	99352	90	101.6	11.1	13.7
176700	99353	90	101.6	13.4	16.9
176698	99351	90	101.6	18	23
125861	99354	90	101.6	23	28
179415	99366	94.74	102.2	19.8	23
117579	99369	95	102.2	21	24
176702	99374	95	102.4	8.7	12.7
176701	99364	95	102.5	11.9	15.1
179416	99372	95.25	102.1	17.5	22.2
179417	99376	95.25	102.2	14.3	17.5
176703	99393	100	109.5	20.6	25.4
176704	99399	101.6	111.1	20.6	25.4
117580	99413	105	113.5	20	23.2
176705	99435	109.93	125	12.9	16.5
124968	99452	115	127	20.6	23.8
176706	99463	117.5	128.6	25.4	31.8
176707	99473	120	129.8	20	25
176708	99475	120.65	127	12.7	19.1
176709	99490	125	137.2	10	14
176710	99492	125	137.2	26	32
179418	99498	127	137.2	17.5	22.2
176711	99494	129.9	139.5	19.1	23.8
135280	99491	130.18	139.5	22	25.3
176712	99552	140	151	20.5	25.4
176713	99571	145	154.9	19.1	22.2



轴修复套

尺寸

产品编码	Ref. No.	d1	D	X	Y
176714	99595	150	159	26	30
176715	99630	160	171.4	25.4	31.8
120709	99650	165.1	177.8	31.8	0
177820	99640	169.88	182.6	31.8	38
176716	99675	171.45	181	20.6	27
176717	99700	177.8	189.9	25.4	31.8
176718	99721	180.01	190.5	33	38
176719	99726	184.86	197.1	32	38
179419	99745	189.31	199.6	20.6	25.4
176720	99750	190.5	200	20.6	25.4
176721	99787	200.03	212.7	34.5	38.1

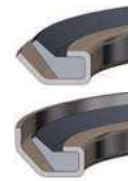

**Germany**

DICTOMATIK GMBH

Albert-Schweitzer-Ring 1
D-22045 Hamburg
P.O.Box 70 04 80
D-22004 Hamburg
Phone +49/40/66 98 90
Fax +49/40/66 98 91 01
mail@dichtomatik.de
www.dichtomatik.de

The Netherlands

DICTOMATIK B.V.

Benjamin Franklinstraat 6
NL-8013 NC Zwolle
Postbus 40 102
NL-8004 DC Zwolle
Phone 038/460 16 06
Fax 038/467 19 00
mail@dichtomatik.nl
www.dichtomatik.nl

Great Britain

DICTOMATIK LIMITED

Donington House
Riverside Road
Pride Park
GB-Derby DE24 8HX
Phone 01332/52 44 00
Fax 01332/52 44 04
mail@dichtomatik.co.uk
www.dichtomatik.co.uk

Austria

DICTOMATIK HANDELSGES. MBH

Rautenweg 17
A-1220 Wien
Phone 01/259 35 41
Fax 01/259 35 41 31
mail@dichtomatik.co.at
www.dichtomatik.co.at

Sweden

DICTOMATIK AB

Hjalmar Brantings Väg 25
S-26143 Landskrona
Box 142
S-26122 Landskrona
Phone 0418/44 98 00
Fax 0418/44 98 20
mail@dichtomatik.se
www.dichtomatik.se

ItalyDICTOMATIK S.a.s.
di Externa Italia S.r.l.

Via Delle Fabbriche 6
I-16158 Genova-Voltri
Phone 010/612 75
Fax 010/613 38 61
mail@dichtomatik.it
www.dichtomatik.it

France

DICTOMATIK S.A.S.

Espace Entreprises
Mâcon Loché TGV
F-71000 Loché
Phone 03/85 27 02 80
Fax 03/85 35 69 37
mail@dichtomatik.fr
www.dichtomatik.fr

Hungary

DICTOMATIK KFT.

Üllői Ut 288
H-1184 Budapest
Phone 01/297 43 45
Fax 01/297 02 18
szimering@hu.inter.net
www.dichtomatik.hu

USADICTOMATIK
NORTH AMERICA

1087 Park Place
Shakopee
Minnesota 55379
Phone 952/894 84 00
Fax 952/894 15 88
sales@dichtomatik.us
www.dichtomatik.us

CanadaDICTOMATIK
North America

950 Denison Steet Unit 21
Markham
Ontario L3R3K5
Phone 905/470 22 66
Fax 905/470 20 55
sales@dichtomatik.ca
www.dichtomatik.ca

China

Dichtomatik (China) Co., Ltd

No.314, Shenxia Road,
Jiading District,
Shanghai 201818
Phone +86/21/60 82 21 78
Fax +86/21/60 82 21 80
mail@dichtomatik.cn
www.dichtomatik.com



DICHTOMATIK

Any seal. Any time.

a brand of



FREUDENBERG